

## Stainless steel valves for water base fluids standard or ex-proof solenoid valves with Multicertification ATEX, IECEx, EAC or cULus certification

**UL certified valves are obsolete components - availability on request**

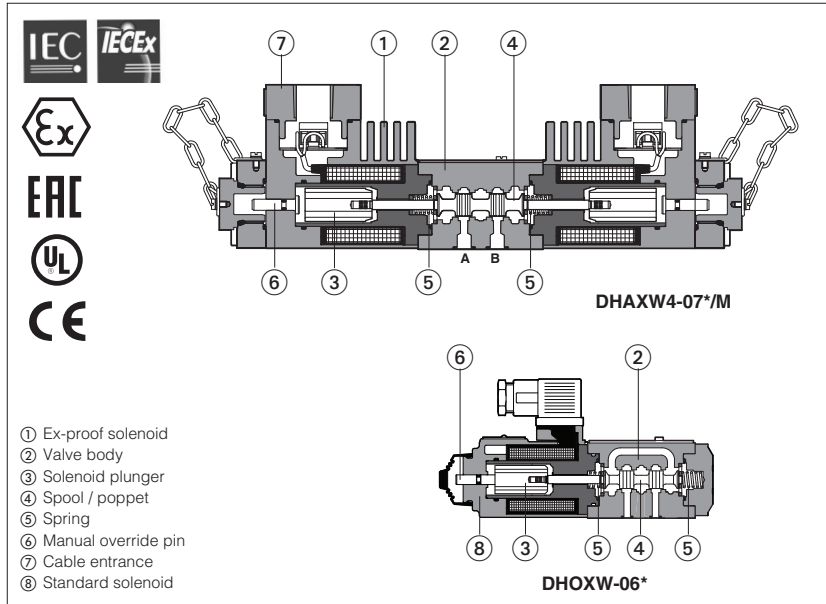

New line of directional solenoid valves with stainless steel internal parts for application with water base fluids.

**Features:**

- These valves are made by selected inoxidizable materials for internal parts to withstand applications with water base fluids or just pure water. External components are derived from standard valves.
  - Two basic versions are available, poppet type, 3-way leak free (suitable for accumulator systems) or spool type, 4-way on-off valves.
  - The valves are available with standard ⑧ or ex-proof solenoids ①, these last certified according to:
    - Multicertification **ATEX, IECEx, EAC**
    - **cULus** certification
  - ISO standard subplate mounting.
- Options** for ex-proof version:
- Handwheel manual override ⑥ (option /V)
  - Manual reset ⑦ (option /R) for safety applications
  - Horizontal cable entrance.
- Common Applications:**  
Steel plants, die casting, foundry.

**1 STAINLESS STEEL VALVES: MAIN DATA**

Code (1)	Description	ISO size	Voltages		Multicertification		cULus		Max flow l/min	Δp (at max flow) bar	Max pressure bar (3)		
			DC	AC 50/60Hz	T class (1)	Input Power	T class (1)	Input Power					
<b>DHOXW</b>	4 way, spool type direct solenoid valves	06 (ISO 4401)	12	-	-	-	32 W (only for 12 and 24 DC)	-	-	60	see diagram at section ⑧	350	
<b>DLOHXW</b>	3 way, poppet type, direct solenoid valves	06 (ISO 4401)	24		-	-	-	-	12	350			
<b>DLOHMxW</b>	3 way, poppet type, direct solenoid valves	06 (ISO 4401)	110		-	-	40 W (only for 110 and 220 DC)	-	25	315			
<b>DLOPXW</b>	3 way, poppet type, piloted solenoid valve	no	220		-	-	-	-	220	315			
<b>DHAXW4</b> <b>DHAXW6</b>	4 way, spool type direct solenoid valves	06 (ISO 4401)	12	12	T6 T4	T4 T3	8 W 25 W	(2) T4	12 W 33 W	60 70	see diagram at section ⑧	350	
<b>DLAHXW4</b> <b>DLAHXW6</b>	3 way, poppet type, direct solenoid valves	06 (ISO 4401)	24		T6 T4	T4 T3	8 W 25 W	(2) T4	12 W 33 W	10 12		315 350	
<b>DLAHMxW4</b> <b>DLAHMxW6</b>	3 way, poppet type, direct solenoid valves	06 (ISO 4401)	48		110	T6 T4	T4 T3	8 W 25 W	(2) T4	12 W 33 W		25 30	250 315
<b>DLAPXW6</b>	3 way, poppet type, piloted solenoid valve	no	220			T6	T4	8 W	(2)	12 W		220	315

**Notes:**

- 1) **XW6** and **XW4** versions differ only for the coil power (see Input Power) - For ATEX, IECEx and EAC multicertification the certified temperature class T6, T4, T3 is related to the max ambient temperature, from which results the max solenoid surface temperature allowed in the application (see section ③). The reference ambient temperature is **-40÷+40°C** (+45° for XW6), for higher ambient temperature (-40÷+70 °C) the temperature class has to be degraded. For cULus certification the temperature class is related to the coil power 12W or 33W
- 2) For **cULus** certification the temperature class corresponding to the coil power 12W is not reported in the nameplate marking. For coil power 33W the temperature class is T4.
- 3) Max pressure on **T** port = **110 bar**  
Valves are provided by HNBR seals, which allow min ambient temperature down to -40 °C (max oil viscosity = 380 cSt). The min ambient temperature for valves with PE option (FPM seals) is -20°C.  
Max ambient temperature without solenoids is 70°C

## 2 MATERIALS SPECIFICATION

Valve type	solenoid housing ①	valve body ②	internal parts ③ + ④	spring ⑤	seals	
					std	/PE
DHAXW DHOXW	Cast iron	AISI 316L	AISI 316L, 420B, 440C, 430F	AISI 302	HNBR (buna)	FPM (viton)
DLOHXW DLOHMxW DLAHXW DLAHMxW	Cast iron	AISI 316L	AISI 316L, 420B, 440C, 430F	AISI 302	HNBR (buna)	FPM (viton)
DLOPXW DLAPXW	Cast iron	AISI 630	AISI 316L, 420B, 440C, 430F	AISI 302	HNBR (buna)	FPM (viton)

## 3 EX-PROOF SOLENOIDS: MAIN DATA

VALVE TYPE		DHAXW6 DLAHXW6	DLAHMXW6 DLAHPXW6	DHAXW4 DLAHXW4	DLAHMXW4
Solenoid code	Multicertification	OAXW/WP		OAKXW/WP	
	cULus	OAXWUL/WP		OAKXWUL/WP	
Voltage code	Vdc ±10%	12DC, 24DC, 48DC (1), 110DC, 220DC			
	VAC 50/60 Hz ±10%	12AC, 24AC, 110-120AC, 230-240AC			
Power consumption	Multicertification	8W		25W	
	cULus	12W		33W	
Coil insulation	Class H				
Protection degree	IP 66/67 According to IEC 144 when correctly coupled with the relevant cable gland, see table K600				
Duty factor	100%				
Mechanical construction	Flame proof housing classified Ex d, according to EN 60079-0: 2006, EN 6079-1: 2007				
Cable entrance and electrical wiring	Internal terminal board for cable connection threaded connection M20x1,5 for cable entrance, vertical (standard) or Horizontal (option /O)				
Method of protection	Ex d				
Temperature class (surface temperature)	Multicertification	T6 (≤ 85°C)	T4 (≤ 135°C)	T4 (≤ 135°C)	T3 (≤ 200°C)
	cULus	Not applicable			T4 (≤ 135°C)
Ambient temperature	Multicertification	-40 ÷ +45 °C	-40 ÷ +70 °C	-40 ÷ +40 °C	-40 ÷ +70 °C
	cULus	-40 ÷ +70 °C			

**Notes:** (1) 48DC only for Multicertification  
For alternating current supply a rectifier bridge is integrated in the solenoid

## 4 MAIN CHARACTERISTICS, SEALS AND HYDRAULIC FLUIDS - for other fluids not included in below table, consult our technical office



Assembly position / location	Any position for all valves		
Subplate surface finishing	Roughness index Ra 0,4 - flatness ratio 0,01/100 (ISO 1101)		
Seals, recommended fluid temperature	HNBR seals (standard) = -40°C ÷ +60°C, with HFC hydraulic fluids = -40°C ÷ +50°C FKM seals (/PE option) = -20°C ÷ +80°C		
Recommended viscosity	15÷100 mm <sup>2</sup> /s - max allowed range 2.8 ÷ 500 mm <sup>2</sup> /s		
Fluid contamination class	ISO 4406 class 21/19/16 NAS 1638 class 10, in line filters of 25 µm (β10 ≥75 recommended)		
<b>Hydraulic fluid</b>	<b>Suitable seals type</b>	<b>Classification</b>	<b>Ref. Standard</b>
Mineral oils	HNBR, FKM	HL, HLP, HLPD, HVLP, HVLPD	DIN 51524
Flame resistant without water	FKM	HFDU, HFDR	ISO 12922
Flame resistant with water	HNBR	HFC	

## 5 cULus CERTIFICATION

### cULus marking

- Class I** = Equipment for famable gas and vapours  
**Division 1** = Possibility of explosive atmosphere during normal functioning  
**Groups C&D** = Gas group (according to UL 1002)  
**Groups IIA&IIB** = Gas group (according to NEC 505-7)  
**T4** = Temperature class of solenoid surface referred to +70°C ambient temperature

### EXAMPLE OF NAMEPLATE MARKING

MODEL CODE	<input type="text"/>		
SERIAL N°	<input type="text"/>	Solenoid for use in hazardous locations	
Class I, Groups C & D		Temperature code <input type="text"/>	
<input type="radio"/> Max ambient temp. 70° C    158° F <input type="radio"/>			
Electrical rating: <input type="text"/>			
<b>CAUTION:</b> To reduce the risk of ignition of hazardous atmospheres, disconnect from circuit before opening enclosure. Keep tightly closed when in operation.			
Notified body and certificate number		T-576/BT	
Marking according to UL Directive			

## 6 MULTICERTIFICATION ATEX, IECEx, EAC

In the following are resumed the valves marking according to multicertifications for Group II





### GROUP II, ATEX, marking

- II 2 G** = Solenoid for surface plants with gas and vapors environment, category 2, suitable for zone 1 and zone 2  
**Ex d** = Explosion-proof equipment  
**II C** = Equipment of group IIC suitable for substances (gas) of group IIC  
**T6/T4** = Solenoid temperature class (maximum surface temperature)  
**Gb** = Equipment protection level, high level protection for explosive Gas atmospheres  
**CE** = Mark of conformity to the applicable European directives  
**II 2 D** = Solenoid for surface plants with dust environment, category 2, suitable for zone 21 and zone 22  
**Ex d** = Explosion-proof equipment  
**III C** = Suitable for conductive dust (applicable also IIIB and/or IIIA)  
**IP66/67** = Protection degree  
**T85/T135** = Maximum surface temperature (Dust)  
**Db** = Equipment protection level, high level protection for explosive Dust atmospheres  
 = Mark of conformity to the 94/9/CE directive and to the technical norms

### GROUP II, IECEx marking

- Ex d** = Explosion-proof equipment  
**IIC** = Equipment of group IIC suitable for substances (gas) of group IIC  
**T6/T4** = Solenoid temperature classes (Gas)  
**Gb** = Equipment protection level, high level protection for explosive Gas atmospheres  
**Ex tb** = Equipment protection by enclosure"tb"  
**IIIC** = Suitable for conductive dust (applicable also IIIB and/or IIIA)  
**T85°C/T135°C** = Maximum surface temperature (Dust)  
**Db** = Equipment protection level, high level protection for explosive Dust atmospheres  
**IP66/67** = Protection degree

### EXAMPLE OF NAMEPLATE MARKING

Atex notified body and certificate number	MODEL N° <input type="text"/>		
	SERIAL N° <input type="text"/>	Atos spa - Via alla Piana, 57 21018 Sesto Calende (Vai) Italy	
Marking according to ATEX Directive	<b>CE 0722 CESI 02 ATEX 014X</b>		
IECEx notified body and certificate number	<input type="radio"/> <b>Ex d IIC T6/T4 Gb</b> <input type="radio"/> <input type="radio"/> <b>Ex tb IIC T85°C / T135°C Db</b>		
Marking according to IECEx Directive	<b>IECEx CES 10.0010X</b>		
Russian notified body and certificate number	 <b>РАЗРЕШЕНИЕ N° РРС 00-044222</b> <b>ОСНОВАНИЕ РОСС ИТ.АВ72.В01735</b>		
Marking according to ATEX Directive	 <b>Ex d IIC T6/T4</b>		
	Supply <input type="text"/> W <input type="text"/> V <input type="text"/> Hz		
	Tamb. - <input type="text"/> ÷ + 45°C / +70°C	IP66/67	
	<b>For the correct selection of connecting cable temperatures see safety instructions</b>		
	AT-907/BT		

### 6.1 EAC marking

EAC certification acknowledges the whole ATEX Directive 94/9/EC. This certification is available only for gas environment (not for dust).

- II 2 G** = Solenoid for surface plants with gas and vapors environment, category 2, suitable for zone 1 and zone 2  
**Ex d** = Explosion-proof equipment  
**II C** = Equipment of group IIC suitable for substances (gas) of group IIC  
**T6/T4** = Solenoid temperature class (maximum surface temperature)  
 = Mark of conformity to the 94/9/CE directive and to the technical norms

**7** **SPOOL TYPE DIRECTIONAL SOLENOID VALVES: MODEL CODE**

<b>DH</b> Spool type - direct	<b>A</b> A = ex-proof solenoids O = standard solenoids	<b>XW</b> Stainless steel execution for internal parts	<b>4</b> Temperature class, see sect. 11 (only for DHA) 4 = T4      6 = T6	<b>*</b> - <b>0</b> Certification type - omit for Multicertification /UL = cULus with 1 m cable length, factory wired	<b>63</b> Size: 0 = 06	<b>1/2</b> - <b>M</b> Valve configuration, see section 7.1 <b>61, 63, 71, 75</b> (configurations 63 and 75 are available only with spool type 1/2)	<b>V</b> Options: A = solenoid at side of port B Options (only for DHA): V = with handweel manual override O = horizontal cable entrance	<b>24DC</b> Voltage code - see section 11	<b>**</b> Series number	<b>/*</b> Seals material, see section 14: - = NBR PE = FKM
----------------------------------	--	---	--	--	---------------------------	---	---	--	----------------------------	---

Solenoid threaded connection (only for DHA):  
**M** = M20x1,5 UNI-4535 (6H/6g)  
**NPT** = 1/2" NPT ANSI B2.1 (tapered) only for /UL

Spool type, see section 7.1

**7.1 Hydraulic configuration**

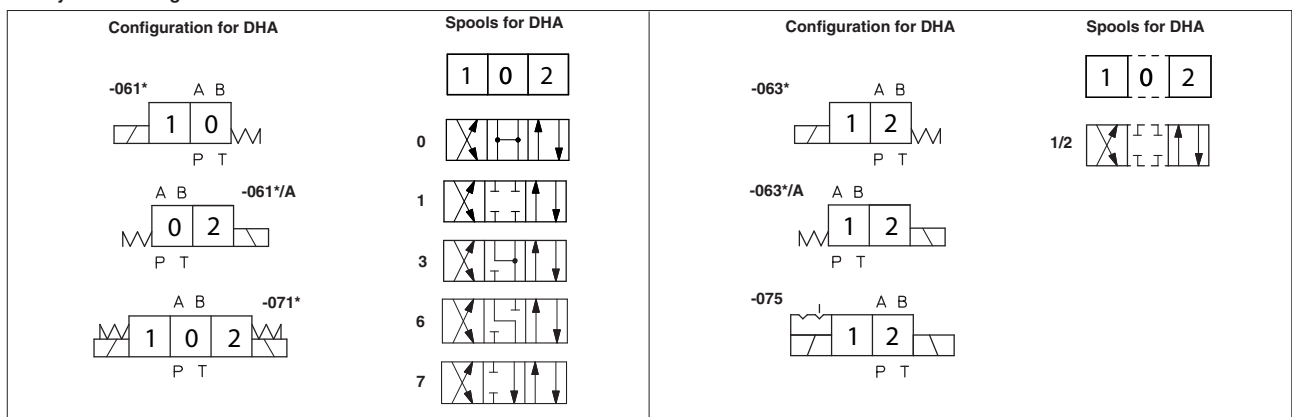

**8** **POPPET TYPE LEAK FREE DIRECTIONAL SOLENOID VALVES: MODEL CODE**

<b>DLOH</b> Standard solenoid DLOH = direct (12 l/min) DLOHM = direct (25 l/min) DLOP = electro-hydraulically piloted Ex-proof solenoid DLAH = direct (10 l/min) DLAHM = direct (25 l/min) DLAP = electro-hydraulically piloted	<b>XW</b> Stainless steel execution for internal parts	<b>6</b> Temperature class, see sect. 11 (only for ex-proof solenoids) 4 = T4 (for DLAH and DLAHM) 6 = T6 (for all ex-proof models)	<b>*</b> - <b>3</b> Certification type - omit for Multicertification /UL = cULus with 1 m cable length, factory wired	<b>A</b> - <b>M</b> Valve configuration, see section 8.1 A = A to T in rest position	<b>V</b> Options (only for ex-proof solenoids): R = with solenoid manual reset V = with handweel manual override O = Horizontal cable entrance	<b>24DC</b> Voltage code - see section 11	<b>**</b> Series number	<b>/*</b> Seals material, see section 14: - = NBR PE = FKM
---	---	--	--	--	--	--	----------------------------	---

Only for DLAPXW  
**D** = internal drain  
**E** = external pilot pressure

Solenoid threaded connection (only for ex-proof solenoids):  
**M** = M20x1,5 UNI-4535 (6H/6g)  
**NPT** = 1/2" NPT ANSI B2.1 (tapered) only for /UL

Options (only for ex-proof solenoids):  
**R** = with solenoid manual reset  
**V** = with handweel manual override  
**O** = Horizontal cable entrance

Only for DLAPXW  
**D** = internal drain  
**E** = external pilot pressure

Solenoid threaded connection (only for ex-proof solenoids):  
**M** = M20x1,5 UNI-4535 (6H/6g)  
**NPT** = 1/2" NPT ANSI B2.1 (tapered) only for /UL

Valve configuration, see section 8.1  
**A** = A to T in rest position      **C** = P to A in rest position

**8.1 Hydraulic configuration**

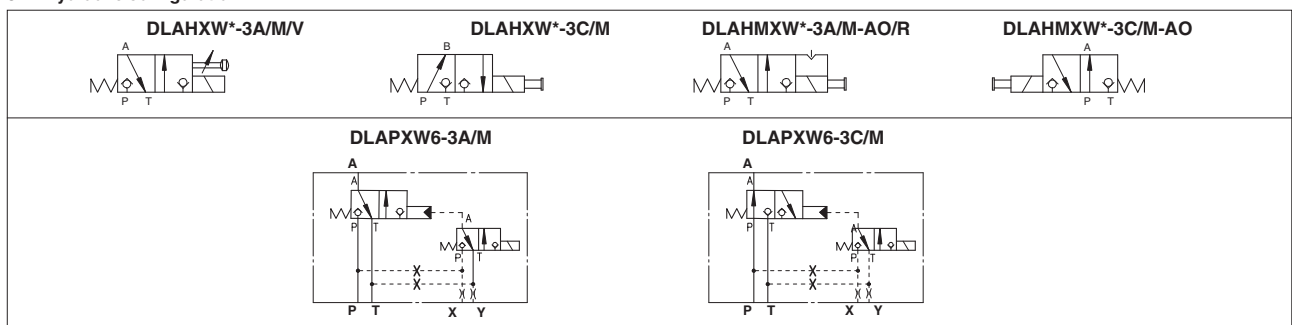

**9 Q/Δp DIAGRAMS** (based on mineral oil ISO VG 46 at 50°C)

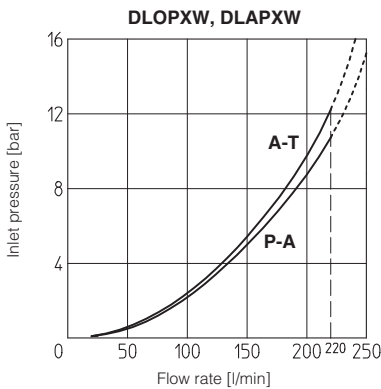
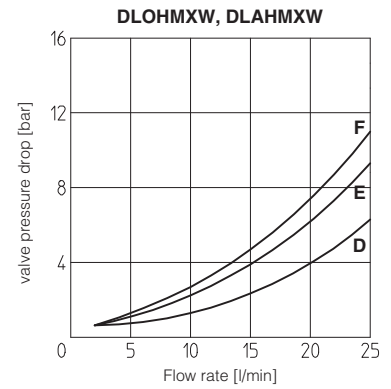
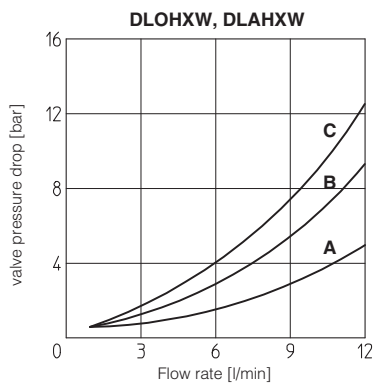
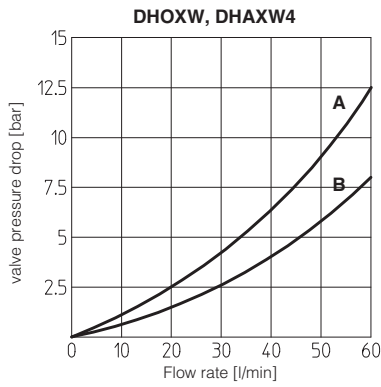

**DHOXW, DHAXW**

Flow direction Spool type	P → A		A → T		P → T
	P → A	P → B	A → T	B → T	
0	B	B	B	B	A
1, 1/2	A	A	A	A	
3	A	A	B	B	
6	A	A	B	A	
7	A	A	A	B	

Valve type	Flow direction	
	P → A (P → B)	A → T (B → T)
<b>DLOHXW-3A</b>	C	B
<b>DLOHXW-3C</b>	B	A
<b>DLOHMXW-3A</b>	F	E
<b>DLOHMXW-3C</b>	E	D

**10 OPERATING LIMITS OF ON/OFF DIRECTIONAL CONTROLS** (based on mineral oil ISO VG 46 at 50°C)

The diagram have been obtained with warm solenoids and power supply at lowest value ( $V_{nom} - 10\%$ ). For DHAXW valves the curves refer to application with symmetrical flow through the valve (i.e. P → A and B → T). In case of asymmetric flow the operating limits must be reduced.

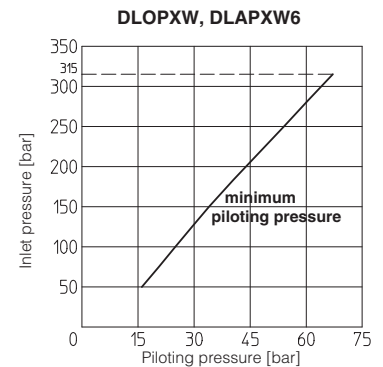
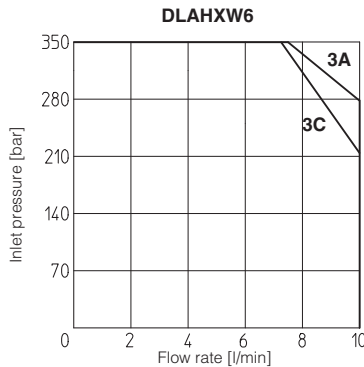
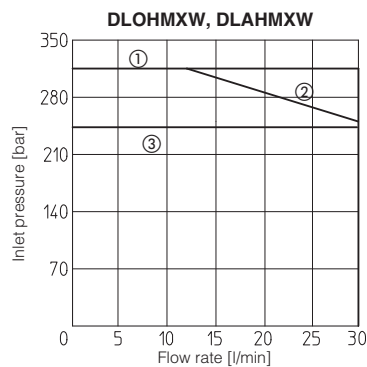
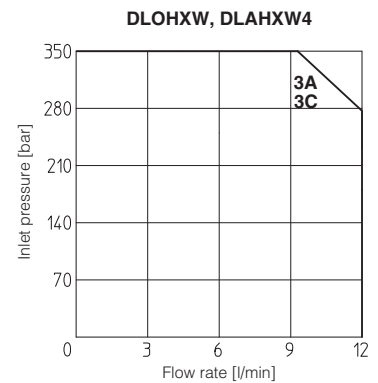
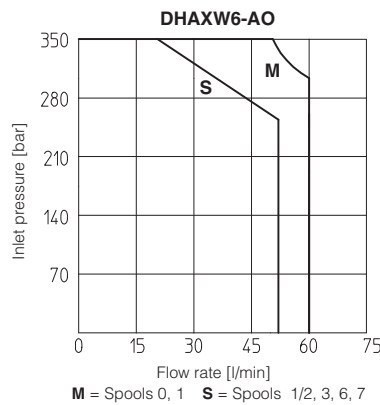
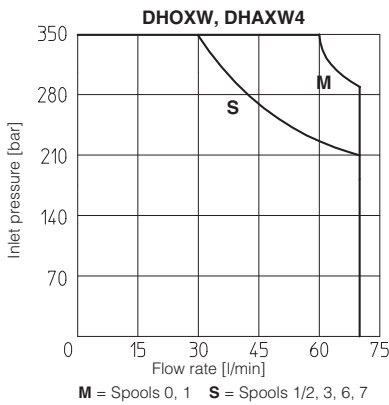

- ① DLOHMXW-3A and DLOKXW4-3A-AO
- ② DLOHMXW-3C and DLOKXW4-3C-AO
- ③ DLOHMXW6-3A(3C)-AO

**10.1 Internal leakages**

internal leakage of DLOHXW, DLOHMXW, DLOPXW: less than 5 drops/min (0,36 cm<sup>3</sup>/min) at max pressure.

**10.2 Piloting pressure (DLOPXW)**

- max piloting pressure = 315 bar
- min piloting pressure = see diagram

**11 INSTALLATION DIMENSIONS OF DHOXW [mm]**

**ISO 4401: 2005**

**Mounting surface: 4401-03-02-0-05**

Fastening bolts:

4 socket head screws M5x50 class 12.9

Tightening torque = 8 Nm

Seals: 4 OR 108

Ports P,A,B,T:  $\varnothing = 7.5$  mm (max).

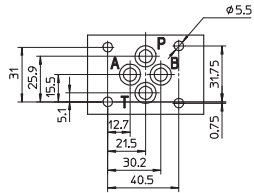

**P** = PRESSURE PORT

**A, B** = USE PORT

**T** = TANK PORT

For the max pressures on ports, see section 4

**DHOXW-06**

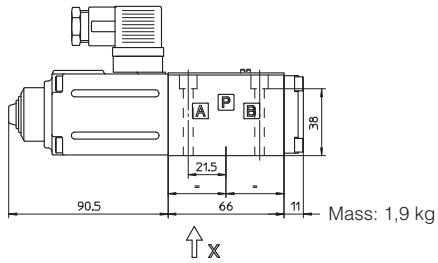

**DHOXW-07**

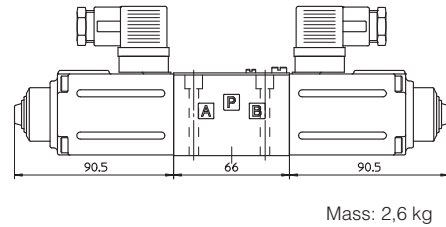

Overall dimensions refer to valves with connectors type 666

**12 INSTALLATION DIMENSIONS OF DLOHMXW [mm]**

**DLOHMXW-3\***

**ISO 4401: 2005**

**Mounting surface: 4401-03-02-0-05**

Fastening bolts:

4 socket head screws M5x50 class 12.9

Tightening torque = 8 Nm

Seals: 4 OR 108

Ports P, A, B, T:

$\varnothing = 7,5$  mm (max)

**DLOHMXW-3C**

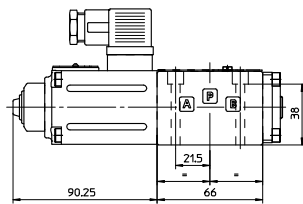

Mass: 1,6 Kg

**DLOHMXW-3A**

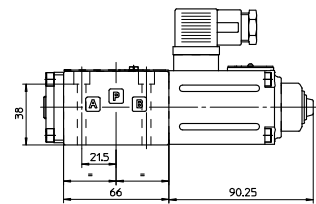

Mass: 1,6 Kg

**P** = PRESSURE PORT

**A** = USE PORT

**B** = CLOSED

**T** = TANK PORT

Overall dimensions refer to valves with connectors type 666

**13 INSTALLATION DIMENSIONS OF DLOPXW [mm]**

**Mounting surface of DLOPXW is not ISO standard**

Fastening bolts:

4 socket head screws M10x70-A4-70

Tightening torque = 40 Nm

Seals: 3 OR 3081; 2 OR 108

Ports P,A,T:  $\varnothing = 16$  mm (max)

Ports X, Y:  $\varnothing = 7$  mm (max)

**DLOPXW-3\***

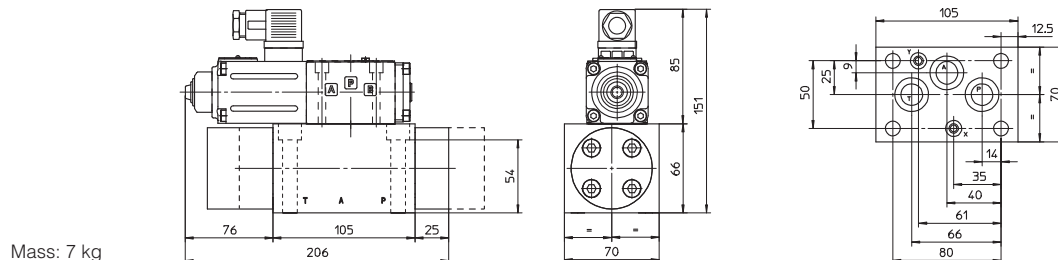

Mass: 7 kg

Overall dimensions refer to valves with connectors type 666

**14** INSTALLATION DIMENSIONS OF EX-PROOF DHAXW [mm]

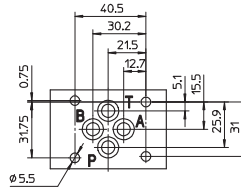
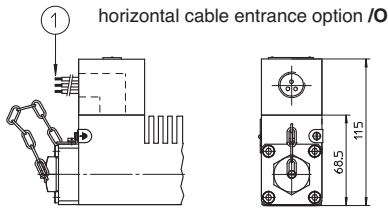

**ISO 4401: 2005**

**Mounting surface: 4401-03-02-0-05**

Fastening bolts:

4 socket head screws M5x50-A4-70

Tightening torque = 5,5 Nm

Seals: 4 OR 108

Ports P,A,B,T:  $\varnothing = 7.5$  mm (max).

**P** = PRESSURE PORT

**A, B** = USE PORT

**T** = TANK PORT

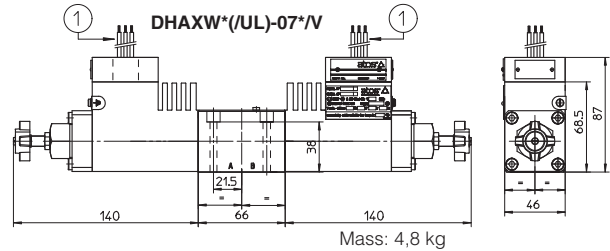
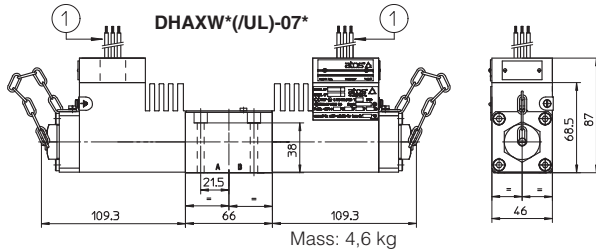
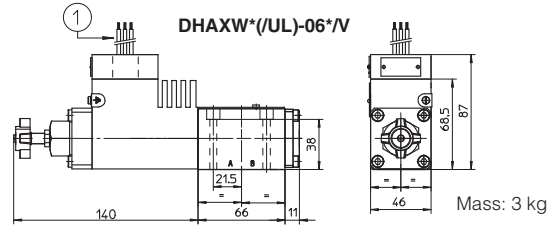
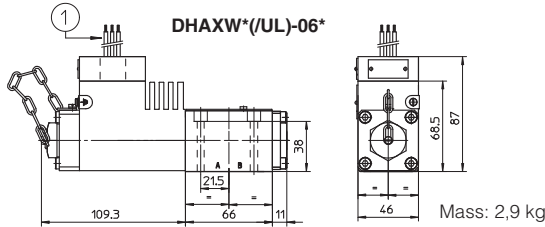

① Only for /UL: factory wired cables (see section 17 for solenoid wiring)

**15** INSTALLATION DIMENSIONS OF EX-PROOF DLAHXW AND DLAHMXW [mm]

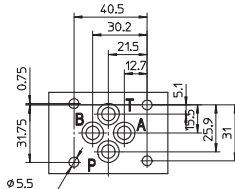
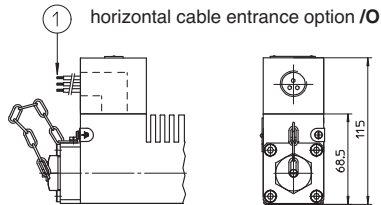

**ISO 4401: 2005**

**Mounting surface: 4401-03-02-0-05**

Fastening bolts:

4 socket head screws M5x50-A4-70

Tightening torque = 5,5 Nm

Seals: 4 OR 108

Ports P,A,B,T:  $\varnothing = 7.5$  mm (max).

**P** = PRESSURE PORT

**A, B** = USE PORT

**T** = TANK PORT

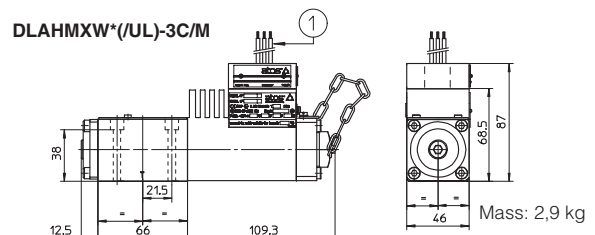
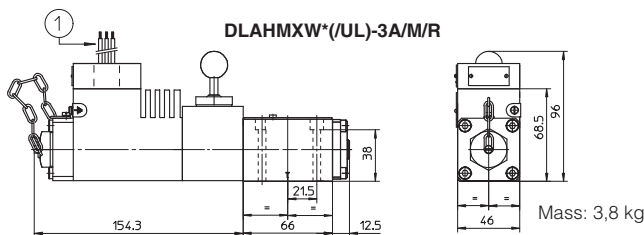
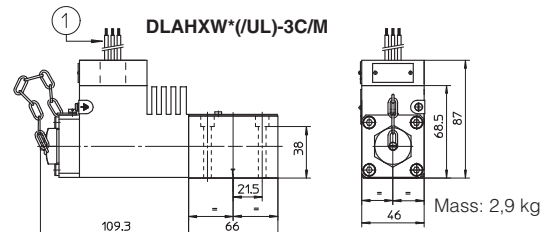
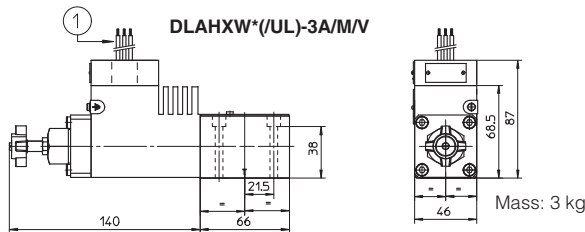

① Only for /UL: factory wired cables (see section 17 for solenoid wiring)

**16** INSTALLATION DIMENSIONS OF EX-PROOF DLAPXW [mm]

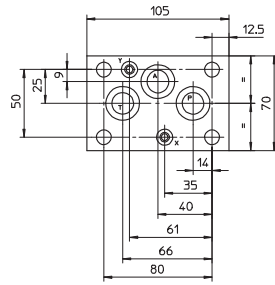

**Mounting surface of DLAPXW is not ISO standard**

Fastening bolts:  
 4 socket head screws M10x70-A4-70  
 Tightening torque = 40 Nm  
 Seals: 3 OR 3081; 2 OR 108  
 Ports P,A,T: Ø = 16 mm (max)  
 Ports X, Y: Ø = 7 mm (max)

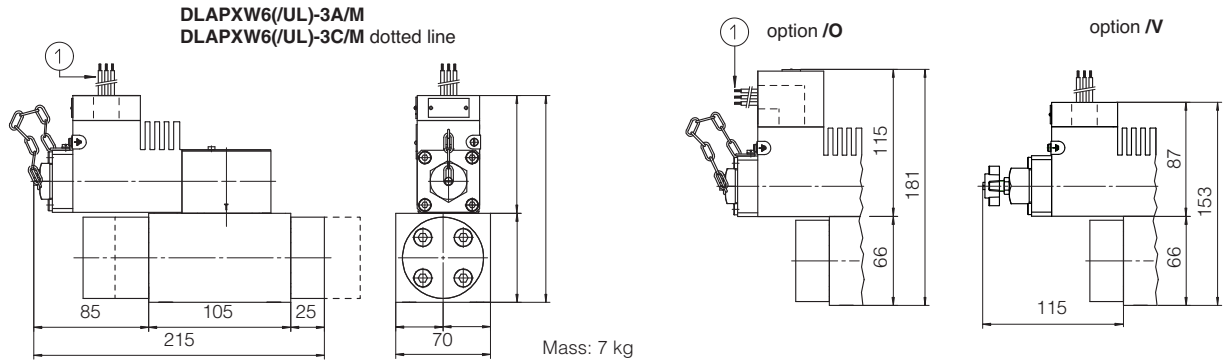

① Only for /UL: factory wired cables (see section 17 for solenoid wiring)

**17** SOLENOID WIRING

**Terminal board (Multicertification ATEX, IECEx, EAC)**

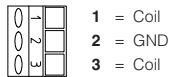

1 = Coil  
 2 = GND  
 3 = Coil

**Wired cables (UL)**

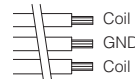

AC	DC
Coil	red
GND	green
Coil	black

**18** CABLE GLANDS - to be ordered separately - see technical table K600

**Wiring specifications**

**The cable must be suitable for the working temperature as specified in the “safety instructions” delivered with the first supply of the products.**

Additional equipotential grounding can be also performed by the user on the external facility provided on the solenoid case.

Minimum section of external ground wire = 4 mm<sup>2</sup>.

Minimum section of internal ground wire = the same of supply wire.