

Modular reducing valves type SHG, SKG

spool type, ISO 4401 sizes 06 and 10

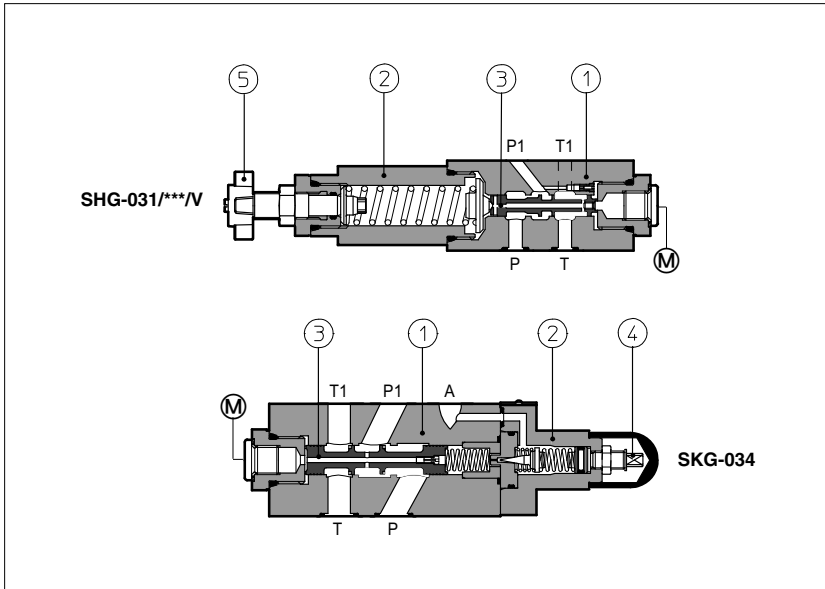

SHG and **SKG** are pressure reducing valves, spool type ③, designed to operate in oil hydraulic systems.

SHG are direct, three way valves; SKG are double stage ① ②, three way valves;

Clockwise rotation increases the pressure.

Valve size and max flow:

SHG = size 06 flow up to 50 l/min;

SKG = size 10 flow up to 100 l/min;

Mounting surface:

ISO 4401 size 06 and 10

Max pressure: **350 bar** for SHG

315 bar for SKG

1 MODEL CODE

SHG-0	31	/	210	/	V	/	**	/	*
Modular pressure reducing valve, size: SHG-0 = 06 SKG-0 = 10							Series number		Seals material, see sect. ③: - = NBR PE = FKM BT = HNBR
Configuration, see section ② three way: 31 = reduced pressure on P port 33 = reduced pressure on A port 34 = reduced pressure on B port			Pressure range SHG 32 = 3 - 32 bar 50 = 2 - 50 bar 75 = 10 - 75 bar				Options: V = setting adjustment by handwheel instead of a grub screw protected by cap		SKG 100 = 7 - 100 bar 210 = 8 - 210 bar

2 HYDRAULIC CHARACTERISTICS

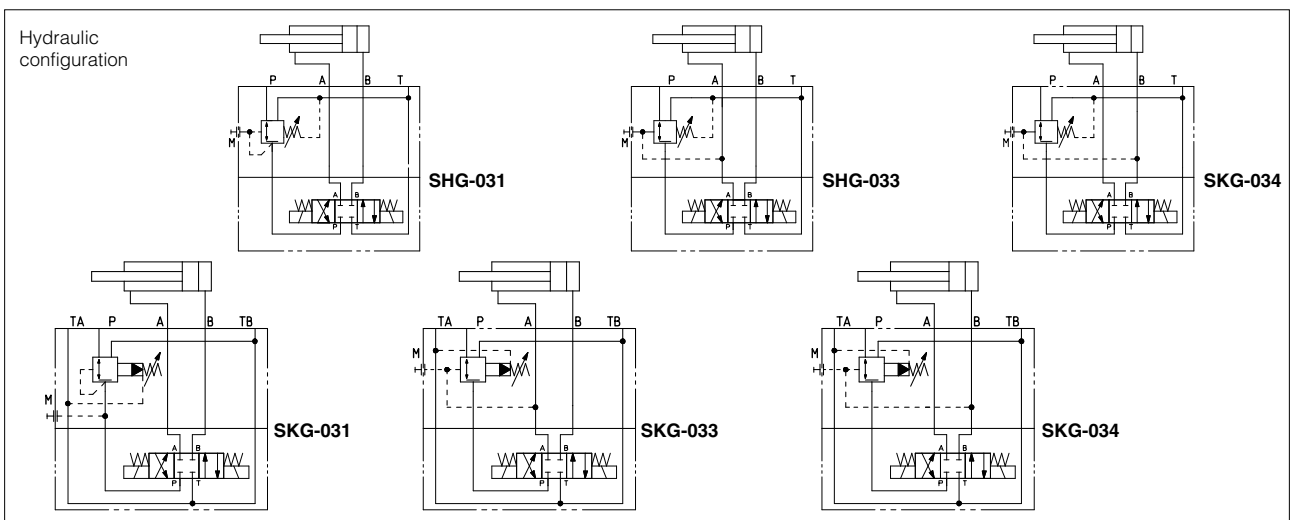

Valve model	SHG-03*/32	SHG-03*/50	SHG-03*/75	SHG-03*/100	SHG-03*/210	SKG-03*/100	SKG-03*/210
Max flow [l/min]	50					100	
Pressure range [bar]	3 ÷ 32	2 ÷ 50	10 ÷ 75	20 ÷ 100	50 ÷ 210	7 ÷ 100	8 ÷ 210
Max inlet pressure [bar]	350					315	
Max pressure on port T [bar]	160					160	

3 MAIN CHARACTERISTICS, SEALS and HYDRAULIC FLUID - for other fluids not included in below table, consult our technical office

Assembly position / location	Any position		
Subplate surface finishing	Roughness index Ra 0,4 - flatness ratio 0,01/100 (ISO 1101)		
MTTFd values according to EN ISO 13849	150 years, for further details see technical table P007		
Ambient temperature	Standard execution = -30°C ÷ +70°C /PE option = -20°C ÷ +70°C /BT option = -40°C ÷ +70°C		
Seals, recommended fluid temperature	NBR seals (standard) = -20°C ÷ +80°C, with HFC hydraulic fluids = -20°C ÷ +50°C FKM seals (/PE option)= -20°C ÷ +80°C HNBR seals (/BT option)= -40°C ÷ +60°C, with HFC hydraulic fluids = -40°C ÷ +50°C		
Recommended viscosity	15 ÷ 100 mm ² /s - max allowed range 2.8 ÷ 500 mm ² /s		
Max fluid contamination level	ISO4406 class 20/18/15 NAS1638 class 9, see also filter section at www.atos.com or KTF catalog		
Hydraulic fluid	Suitable seals type	Classification	Ref. Standard
Mineral oils	NBR, FKM, HNBR	HL, HLP, HLPD, HVLP, HVLPD	DIN 51524
Flame resistant without water	FKM	HFDR, HFDR	ISO 12922
Flame resistant with water	NBR, HNBR	HFC	

4 DIAGRAMS OF SHG-03* based on mineral oil ISO VG 46 at 50°C

- 1** = regulated pressure variation versus flow:
 - between use port and discharge port
 - between inlet port and use port
- 2** = differential pressure variation versus flow between inlet port and use port
- 3** = differential pressure variation versus flow between use port and discharge port

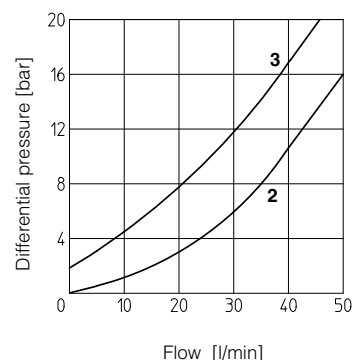
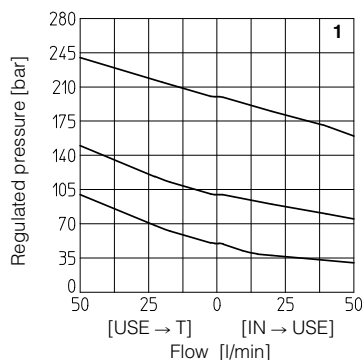

5 DIAGRAMS OF SKG-03* based on mineral oil ISO VG 46 at 50°C

- 1** = regulated pressure variation versus flow:
 - between use port and discharge port
 - between inlet port and use port
- 2** = differential pressure variation versus flow between inlet port and use port
- 3** = differential pressure variation versus flow between use port and discharge port

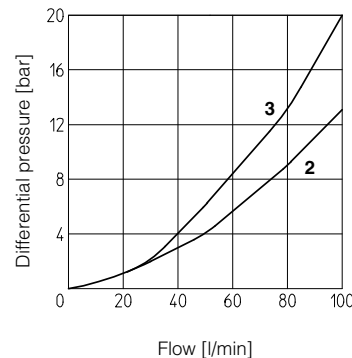
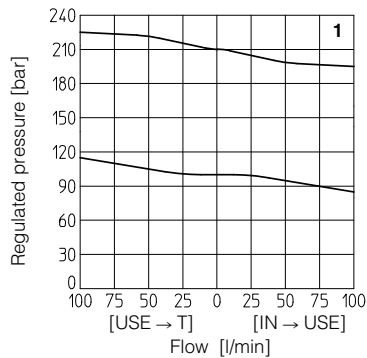

6 INSTALLATION DIMENSIONS OF SHG-0 VALVES [mm]

SHG-03*

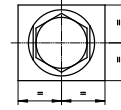
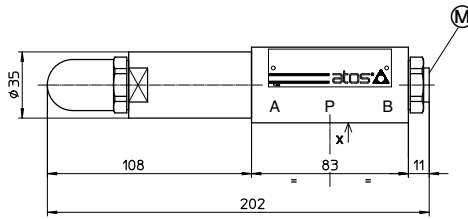
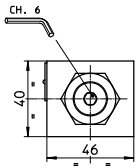

M = Pressure gauge port = G 1/4"

Mass: 2,3 Kg

Adjustment device for option /V

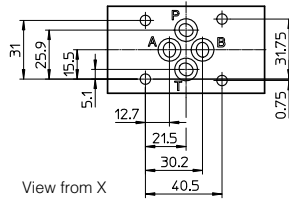
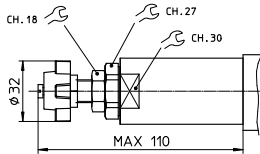

ISO 4401: 2005

Mounting surface: 4401-03-02-0-05

Diameter of ports A, B, P, T: $\varnothing = 7,5$ mm

Seals: 4 OR 108

Fastening bolts: n° 4 socket head screws M5. The length depends on number and type of modular elements associated.

7 INSTALLATION DIMENSIONS OF SKG-0 VALVES [mm]

SKG-03*

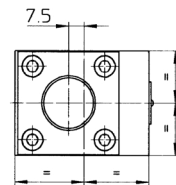
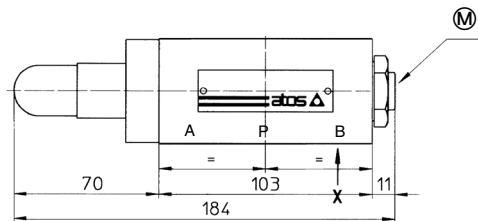
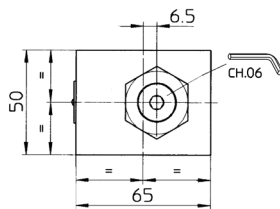

M = Pressure gauge port = G 1/4"

Mass: 3,8 kg

Adjustment device for option /V

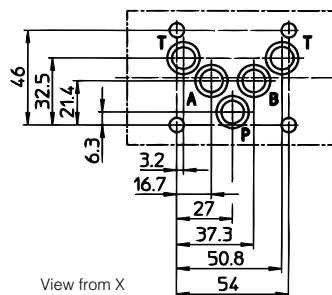
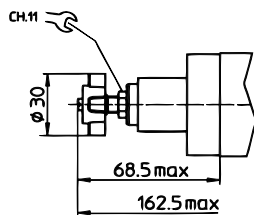

ISO 4401: 2005

Mounting surface: 4401-05-04-0-05

Diameter of ports A, B, P, T: $\varnothing = 11,2$ mm

Seals: 5 OR 2050

Fastening bolts: n° 4 socket head screws M6. The length depends on number and type of modular elements associated.