

# Digital electronic drivers type **E-RI-TEs**, **E-RI-LES** with /S\* options

integral-to-valve format, for proportional valves with additional alternate P/Q control

**obsolete components - availability on request**

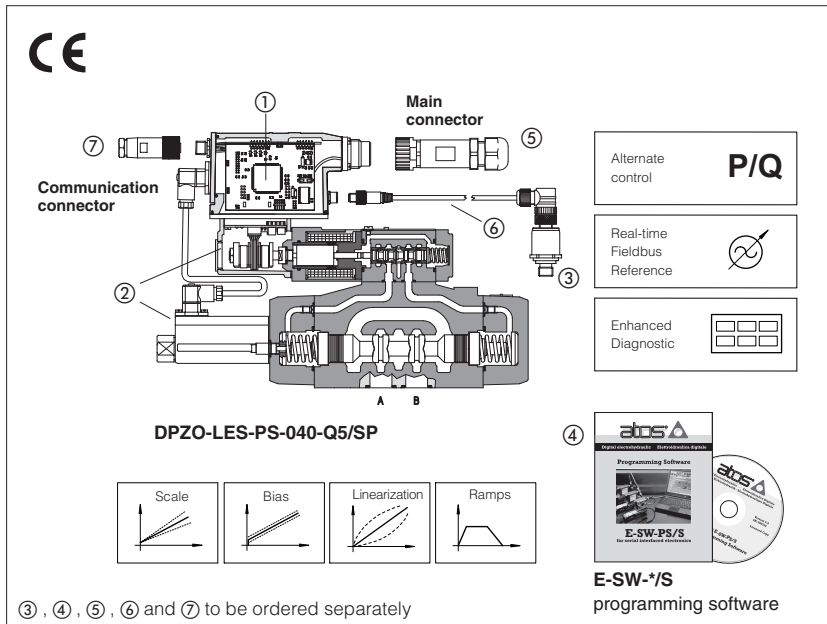

The integral digital drivers ① with /S\* option add a pressure or force closed loop to the spool/poppet control of standard directional proportional valves (see tab. G210).

The controls are operated according to the two electronic reference signals and a dedicated algorithm automatically selects which control will be active time by time.

The dynamics of the switching between the two controls can be regulated thanks to specific software setting, in order to avoid instability or vibrations.

Flow control is active when the actual system pressure/force is lower than the relevant input reference signal - the valve works normally to regulate the flow by controlling in closed-loop the spool/poppet through the integral position transducer(s) ②.

Pressure/force control is activated when the actual system pressure/force, measured by remote transducers ③ - see section ②, grows up to the relevant input reference signal - the driver reduces the valve's flow regulation in order to keep the system pressure/force stable; if the pressure/force tends to decrease under its input reference signal, the flow control returns active.

The dynamic response of pressure/force control can be adapted to different system's characteristics, by setting the internal PID parameters.

4 sets of PID parameters can be stored into the driver and then selected by the machine control units during the axis motion cycle by means of two on/off inputs or by fieldbus.

Digital communication interface allows to program the drivers with the Atos PC software ④ or, for -BC and -BP fieldbus execution, directly by the machine control unit.

**Electrical Features:**

- Functional parameters are factory preset for best performances
- Standard 12 pin main connector ⑤ for double power supply, analog input references and monitors, enable and fault signals
- 4 pin connector ⑥ for remote pressure or force transducers
- 5 pin connector ⑦ for communication interface, at choice: serial -PS or fieldbus -BC and -BP
- IP67 protection degree
- CE mark according to EMC directive

**Software Features:**

- Setting of valve's functional parameters: bias, scale, ramps, dither and linearization
- 4 sets of pressure/force PID parameters allow to adapt the dynamic response
- Complete diagnostics of driver status
- Intuitive graphic interface

**1 MODEL CODE**

<b>E-RI</b>	<b>- TE</b>	<b>S</b>	<b>- PS</b>	<b>- 01H</b>	<b>*</b>	<b>**</b>	<b>/</b>	<b>*</b>
Integral electronic driver								Set code (see note)
<p><b>TE</b> = for proportional valves with one position transducer</p> <p><b>LE</b> = for proportional valves with two position transducers</p>								Series number
<p><b>S</b> = digital electronic</p>								
<p><b>PS</b> = Serial communication interface</p> <p><b>BC</b> = CANopen communication interface</p> <p><b>BP</b> = PROFIBUS DP communication interface</p>								
<p><b>01H</b> = for single solenoid proportional valves</p> <p><b>05H</b> = for double solenoid proportional valves (only for -TES)</p>								
					<p><b>Options, see section ⑨:</b></p> <p><b>SP</b> = closed loop pressure control with 1 remote pressure transducer</p> <p><b>SF</b> = closed loop force control, with 2 remote pressure transducers</p> <p><b>SL</b> = closed loop force control with 1 remote load cell</p> <p><b>C</b> = current feedback input for remote transducer signal(s)</p> <p><b>I</b> = current reference input and monitor (4 ÷ 20 mA) signals</p>			

**Note:** The set code identifies the correspondence between the digital integral driver and the relevant valve; it is assigned by Atos when the driver is ordered as a spare part.

**2 CONTROL DIAGRAM**

/SP option	/SF option	/SL option
<p>Pressure closed loop control is available on one of the valve's user port: a remote pressure transducer has to be installed in the hydraulic system on the pressure connection to be controlled</p>	<p>Force closed loop control is available on the actuator operated by the valve: two remote pressure transducers have to be installed on the actuator's ports. The actuator force is calculated by the pressure feedbacks (P<sub>a</sub> - P<sub>b</sub>)</p>	<p>Force closed loop control is available on the actuator operated by the valve: one load cell transducer has to be installed between the actuator and the controlled load</p>
<p> <span style="color: green;">■</span> E-RI-TEs=integral digital driver              <span style="color: blue;">■</span> integral valve spool transducer              <span style="color: red;">■</span> remote pressure transducer              <span style="color: purple;">■</span> remote load cell transducer         </p>		

### 3 Application examples of alternate P/Q controls

The following applications examples are intended just as generic reference of the possible configurations with the digital integral electronics with /S\* option.

The Atos technical services are available for additional evaluations related to specific applications usage, please contact our technical office.

#### High-dynamic pressure reducing controls (/SP option)

3 way or 4 way directional proportional valves with /SP option, in subplate mounting or cartridge execution, are operated in 3-way hydraulic configuration to control speed/pressure (force) on the A user port (see 3.1):

- flow reference signal is used to limit the maximum flow during the pressure regulation
- pressure reference signal is used to regulate the pressure on the valve's A user port; the rapid/repeatable response of the pressure control is performed in high dynamics by the directional valve's closed loop regulation

- Requirements:**
- a remote pressure transducer has to be installed in the hydraulic system on the controlled user port (when using 4 way valves either A or B port can be used while the not controlled port must be plugged)
  - zero overlap spool and valve without fail safe position are recommended; positive overlap valves with PABT ports closed in central position has not to be used

#### Single effect actuators with speed/pressure (force) controls (/SP or /SL option)

3 way or 4 way directional proportional valves with /SP or /SL options, in subplate mounting or cartridge execution, are operated in 3-way hydraulic configuration to control speed/pressure (force) on single effect actuators (see 3.2):

- flow reference signal is used to regulate the actuator's forward and backward speed while pressure (force) reference signal is used to limit the maximum pushing pressure (force) to the actuator
- or
- pressure (force) reference signal is used to regulate the actuator pushing pressure (force) while flow reference signal is used to limit the maximum actuator speed

- Requirements:**
- for /SP a remote pressure transducer has to be installed in the hydraulic system on the actuator pushing port (when using 4 way valves either A or B port can be used while the not controlled port must be plugged)
  - for /SL a remote force transducer has to be installed between the actuator and the controlled load
  - zero overlap spool is recommended; positive overlap valves with PABT ports closed in central position has not to be used

#### Double effect actuators with speed/pressure controls (/SP option)

4 way directional proportional valves with /SP option, in subplate mounting execution, control speed/pressure on double effect actuators (see 3.3):

- flow reference signal is used to regulate the actuator's forward and backward speed while pressure reference signal is used to limit the maximum pushing pressure to the actuator
- or
- pressure reference signal is used to regulate the actuator pushing pressure while flow reference signal is used to limit the maximum forward and backward actuator speed

- Requirements:**
- a remote pressure transducer has to be installed on the actuator's pushing port
  - dedicated spool with strong "meter-in" characteristic in central position has to be used; during depressurizing phases the not controlled port remains at zero pressure (T port connection) - see section 4

#### Double effect actuators with force limit/regulation (/SF or /SL option)

4 way directional proportional valves with /SF or /SL option, in subplate mounting execution, control speed/force on double effect actuators (see 3.4, 3.5):

- flow reference signal is used to regulate the actuator's forward and backward speed while force reference signal is used to limit the maximum pushing and pulling force to the actuator
- or
- force reference signal is used to regulate the actuator pushing and pulling force while flow reference signal is used to limit the maximum actuator speed

- Requirements:**
- for /SF two remote pressure transducers have to be installed on the both actuator's ports
  - for /SL one push/pull load cell transducer has to be installed between the actuator and the controlled load
  - zero overlap spool is recommended; positive overlap valves with PABT ports closed in central position has not to be used

- Advantages:**
- force control is possible in both push and pull directions
  - /SL option allows a more precise force control despite of a more complex installation of the load cell transducer
  - /SF option allows to add force control also into existing systems thanks to the simple installation of pressure transducers

- Control modes:**
- Flow priority: flow reference signal is used to move forward and backward the actuator while force is limited/regulated in both push and pull direction
  - Force priority: force reference signal is used to control both push and pull forces while flow is limited/regulated in both direction

#### Notes:

- sleeve execution valves are recommended for high accuracy applications.
- auxiliary check valves are recommended in case of specific hydraulic configuration requirements in absence of power supply or fault, see table E115.

#### 3.1 - 3 way connection with /SP option

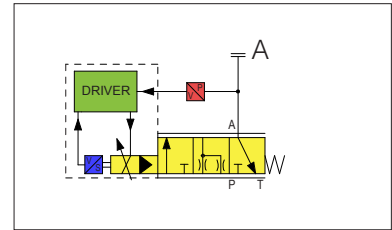

#### 3.2 - 3 way connection with /SL option

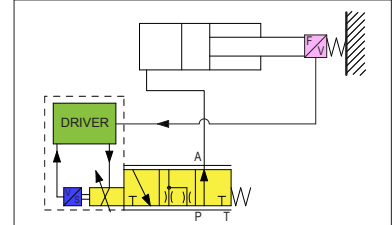

#### 3.3 - 4 way connection with /SP option

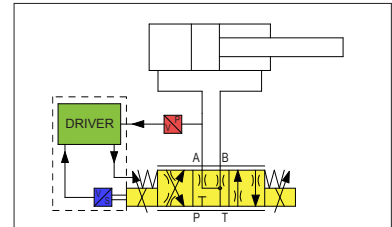

#### 3.4 - 4 way connection with /SF option

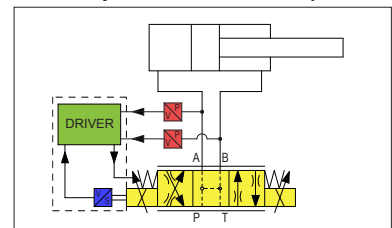

#### 3.5 - 4 way connection with /SL option

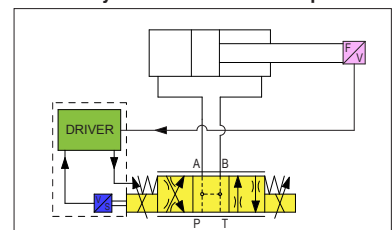

#### 3.6 - Flow priority

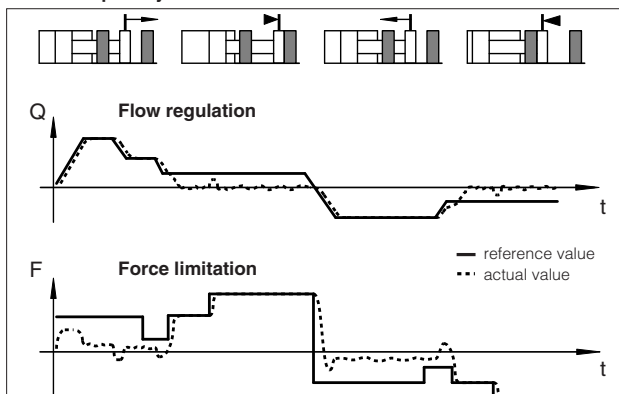

#### 3.7 - Force priority

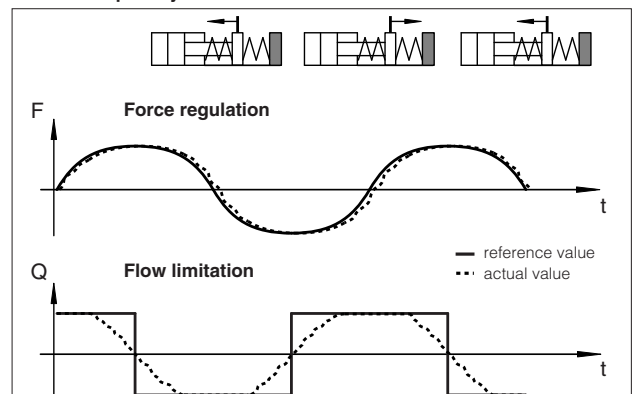

**4 Special spools for 4 way connection with /SP option**

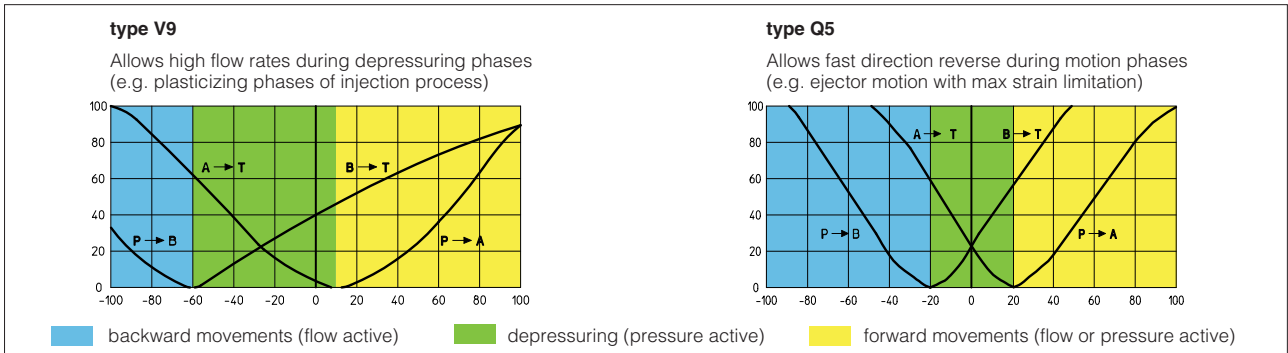

**5 BLOCK DIAGRAM**

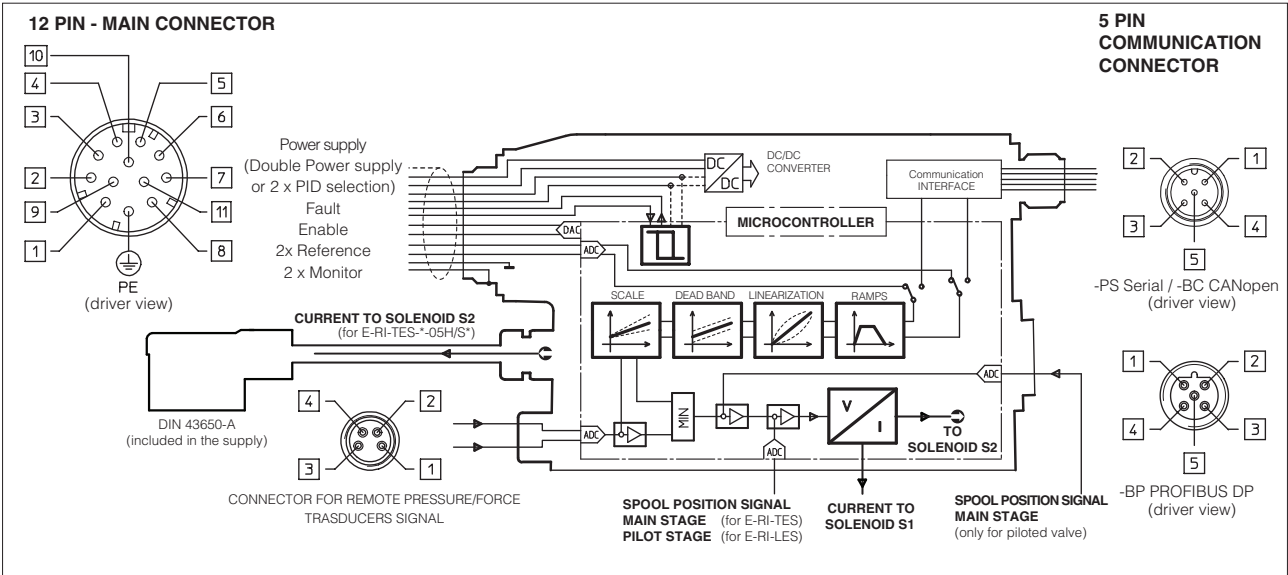

**6 ELECTRONIC CONNECTIONS - 12 PIN MAIN CONNECTOR**

Pin	SIGNAL	TECHNICAL SPECIFICATIONS	NOTES
1	V+	Power supply 24 V <sub>DC</sub> for solenoid power stage (see 9.1)	Input - power supply
2	V0	Power supply 0 V <sub>DC</sub> for solenoid power stage (see 9.1)	Gnd - power supply
3	ENABLE	Enable (24 V <sub>DC</sub> ) or disable (0 V <sub>DC</sub> ) the driver (see 9.6)	Input - on/off signal
4	Q_INPUT+	Flow reference analog input: ±10 V <sub>DC</sub> maximum range (4 ÷ 20 mA for /I option) common mode INPUT+ referred to AGND (see 9.2)	Input - analog signal
5	AGND	Ground : signal zero for P_INPUT+ and Q_INPUT+ ; signal zero for MONITOR	Gnd - analog signal
6	Q_MONITOR	Flow monitor analog output: ±10 V <sub>DC</sub> maximum range (4 ÷ 20 mA for /I option) - see 9.3	Output - analog signal
7	P_INPUT+ (F_INPUT+)	Pressure (force) reference analog input: ±10 V <sub>DC</sub> maximum range (4 ÷ 20 mA for /I option) common mode INPUT+ referred to AGND (see 9.2)	Input - analog signal
8	P_MONITOR (F_MONITOR)	Pressure (force) monitor analog output: ±10 V <sub>DC</sub> maximum range (4 ÷ 20 mA for /I option) - see 9.3	Output - analog signal
11	FAULT	Driver status output: Fault (0 V <sub>DC</sub> ) or normal working (24 V <sub>DC</sub> ) - see 9.7	Output - on/off signal
PE	EARTH	Internally connected to driver housing	Earth
<b>PS execution</b>			
9	D_IN0	Multiple pressure PID selection (see 9.4)	Input - on/off signal
10	D_IN1	Multiple pressure PID selection (see 9.4)	
<b>BC and BP execution</b>			
9	VL+	Power supply 24 V <sub>DC</sub> for driver's logic (see 9.5)	Input - power supply
10	VL0	Power supply 0 V <sub>DC</sub> for driver's logic (see 9.5)	Gnd - power supply

**7 ELECTRONIC CONNECTIONS - 4 PIN REMOTE PRESSURE (FORCE) TRANSDUCER M8 CONNECTOR**

PIN	/SP, /SL, /SF options	/CSP, /CSL, /CSF options (Ri = 316 Ω)
1	TR1 remote transducer signal (0 ÷ 10 V <sub>DC</sub> ) - see 9.8	TR1 remote transducer signal (4 ÷ 20 mA) - see 9.8
2	AGND signal zero for power supply and signal	NC reserved (do not connect)
3	VT remote transducer power supply 24 V <sub>DC</sub>	VT remote transducer power supply 24 V <sub>DC</sub>
4	TR2 2nd remote transducer (0 ÷ 10 V <sub>DC</sub> ) - only for /SF option	TR2 2nd remote transducer (4 ÷ 20 mA) - only for /SF option

See tab. G465 for the pressure transducer characteristics and connections.

## 8 ELECTRONIC CONNECTIONS - 5 PIN COMMUNICATION M12 CONNECTOR

PIN	-PS Serial		-BC CANopen		-BP PROFIBUS DP	
	SIGNAL	TECHNICAL SPECIFICATION	SIGNAL	TECHNICAL SPECIFICATION	SIGNAL	TECHNICAL SPECIFICATION
1	NC	do not connect	CAN_SHLD	Shield	+5V	for termination
2	NC	do not connect	NC	do not connect	LINE-A	Bus line (high)
3	RS_GND	Signal zero data line	CAN_GND	Signal zero data line	DGND	data line and termination Signal zero
4	RS_RX	Valves receiving data line	CAN_H	Bus line (high)	LINE-B	Bus line (low)
5	RS_TX	Valves transmitting data line	CAN_L	Bus line (low)	SHIELD	

## 9 SIGNALS SPECIFICATIONS

Atos proportional valves are CE marked according to the applicable directives (e.g. Immunity/Emission EMC Directive). Installation, wirings and start-up procedures must be performed according to the general prescriptions shown in table F003 and in the user manuals included in the E-SW-\*/S programming software.

The electrical signals of the valve (e.g. monitor signals) must not be directly used to activate safety functions, like to switch-ON/OFF the machine's safety components, as prescribed by the European standards (Safety requirements of fluid technology systems and components-hydraulics, EN-982).

### 9.1 Power supply and wirings (V+ and V0)

The power supply must be appropriately stabilized or rectified and filtered: apply at least a 10000 µF/40 V capacitance to single phase rectifiers or a 4700 µF/40 V capacitance to three phase rectifiers.

A safety fuse is required in series to each driver power supply: 2,5 A fuse.

Note: pin 2 and 10 (zero Volt) are connected together inside the electronics.

### 9.2 Reference Input Signals (Q\_INPUT+ and P\_INPUT+ / F\_INPUT+)

The driver is designed to receive two analog reference input signals for the valve's spool position and system's pressure (force); both references are referred to the common mode signal zero (AGND).

The inputs range and polarity are software selectable within the ±10 Vdc maximum range; default settings are 0 ÷ 10 Vdc.

Drivers with fieldbus interface (-BC or -BP) can be software set to receive reference values directly by the machine control unit (fieldbus master); in this case the analog reference input signals can be used for start-up and maintenance operations.

#### Option /I

The max range of reference input signals are software selectable among 4 ÷ 20 mA (default with cable break detection), ±10 mA, ±20 mA or 0 ÷ 20 mA

### 9.3 Monitor Output Signal (Q\_MONITOR+ and P\_MONITOR+ / F\_MONITOR+)

The driver generates two analog output signals to monitor the actual spool position of the valve and to the actual system pressure (force); the monitor output signals can be software set to show other signals available in the driver (e.g. analog reference, fieldbus reference, pilot spool position).

The output polarity is software selectable within ±10 Vdc maximum range; default settings are 0 ÷ 10 Vdc.

#### Option /I

The maximum range of monitor output signal is 4 ÷ 20 mA

### 9.4 Multiple PID selection (D\_IN0 and D\_IN1) - only for -PS execution

Two on-off input signals are available on the main connector to select one of the four pressure (force) PID parameters setting, stored into the driver.

Switching the active setting of pressure PID during the machine cycle allows to optimize the system dynamic response in different hydraulic working conditions (volume, flow, etc.).

Supply a 24 V or a 0 V on pin 9 and/or 10, to select one of the PID settings as indicated in the table at side.

PID SET SELECTION				
PIN	SET 1	SET 2	SET 3	SET 4
9	0	0	24 Vdc	24 Vdc
10	0	24 Vdc	24 Vdc	0

### 9.5 Logic power supply (VL+ and VL0) - only for -BC or -BP execution

Separate power supply for the solenoid and for the digital electronic circuits (pin 9,10).

Cutting solenoid power supply (pin 1,2) allows to interrupt the valve functioning but keeping energized the digital electronics thus avoiding fault conditions of the machine fieldbus controller.

This condition allows to realize safety systems in compliance with European Norms EN13849-1 (ex EN954-1).

A safety fuse is required in series to each driver power supply: 500 mA fast fuse.

Note: pin 2 and 10 (zero Volt) are connected together inside the electronics.

### 9.6 Enable Input Signal (ENABLE)

To enable the driver, supply a +24 Vdc on pin 3 referred to pin 2: when the Enable signal is set to zero the valve functioning is disabled but the driver current output stage is still active. This condition does not comply with European Norms EN13849-1 (ex EN954-1).

### 9.7 Fault Output Signal (FAULT)

Fault output signal indicates fault conditions of the driver (solenoid short circuits/not connected, reference signal cable broken for 4 ÷ 20 mA input, valve spool/pressure transducers cable broken, etc.). Fault presence corresponds to 0 Vdc, normal working corresponds to 24 Vdc (pin 11 referred to pin2).

Fault status is not affected by the status of the Enable input signal.

### 9.8 Pressure Transducer Input Signal (TR)

Remote pressure (force) transducers must be directly connected to the driver using a dedicated M8 connection (see section 7).

The inputs range and polarity are software selectable within the ±10 Vdc maximum range; default settings are 0 ÷ 10 Vdc.

#### Option /C

The maximum range of remote pressure (force) transducer signals are software selectable among 4 ÷ 20 mA (default with cable break detection) or 0 ÷ 20 mA

### 9.9 Possible combined options: /CSF, /CSL, /CSP, /ISF, /ISL, /ISP, /CISF, /CISL and /CISP

## 10 SOFTWARE TOOLS

The driver configuration and parameters can be easily set with the Atos E-SW programming software, available in three different versions according to the driver's communication interfacing: E-SW-PS/S (Serial), E-SW-BC/S (CANopen) and E-SW-BP/S (PROFIBUS DP).

A proper connection is required between the PC and the electronic driver communication port: for a more detailed description of software interface, PC requirements, adapters, cables and terminators, please refer to technical table GS500.

Proportional valves with fieldbus communication interface (-BC and -BP) can be directly managed by the machine control unit; it is required to implement in the machine control the Atos communication protocol as described in the user manuals supplied with the relevant programming software.

### Programming software, must be ordered separately :

**E-SW-\*/S** (mandatory - first supply) = Dvd including E-SW-\*/S software installer and operator manuals; it allows the registration to Atos digital service

**E-SW-\*/N/S** (optional - next supplies) = as above but not allowing the registration to Atos digital service

On first supply of the E-SW-\*/S software, it is required to apply for the registration in the Atos download area : [www.download.atos.com](http://www.download.atos.com) .

Once the registration is completed, the password will be sent by email.

The software remains active for 10 days from the installation date and then it stops until the user inputs his password.

With the password you can also download, in your personal area, the latest releases of the Atos software, manuals, drivers and configuration files.

### USB Adapters, Cables and Terminators can be ordered separately (see tab. GS500)

## 11 MAIN SOFTWARE PARAMETER SETTINGS

The following is a brief description of the main settings and features of E-RI-(TE)LES-\*/S\* drivers. For a detailed descriptions of the available settings, wirings and installation procedures, please refer to the programming manuals included in the E-SW-\*/S programming software (see [10](#)).

### 11.1 Scale (Flow and Pressure/Force)

Scale function allows to set the maximum valve regulation at maximum reference signal values. Two different flow Scale regulations are available for double solenoid valves or three position single solenoid valves: ScaleA for positive and ScaleB for negative reference signal.

### 11.2 Bias and Threshold (Flow)

Proportional valves may be provided with a dead band in the hydraulic regulation corresponding to their switch-off status.

This dead band discontinuity in the valve's regulation can be compensated by activating the Bias function, which adds a fixed preset Bias value to the reference signal (analog or fieldbus external input).

The Bias function is activated when the reference signal overcome the Threshold value, preset into the driver.

The Bias setting allows to calibrate the Bias valve opening to the specific proportional valve to which the driver is coupled.

The Threshold setting is useful to avoid undesired valve regulation at 0 Vbc reference signal when electric noise is present on the analog input signal: smaller threshold reduces the reference signal dead band, greater values are less affected by electric noise presence.

If fieldbus reference signal is active (see 9.2), threshold should be set to zero.

Two different Bias regulations are available for double solenoid valves or three position single solenoid valves: positive reference signals activate BiasA and negative reference signals activate BiasB.

Refer to the programming manuals for a detailed description of other software selectable Bias functions.

### 11.3 Offset (Flow)

Proportional valves may be provided with zero overlapping in the hydraulic regulation corresponding to zero reference input signal (valve's central spool position).

The Offset function allows to calibrate the valve's spool central position to the specific hydraulic system setup (e.g. valve applied to cylinder with differential areas). Offset default setting is zero.

### 11.4 Bias (Pressure)

Pressure control can be limited in the minimum regulation: the minimum pressure depends on the valve size, the regulated flow and the T port pressure.

Desired pressure requested through the reference signal (analog or fieldbus external input), must be greater than the minimum pressure to obtain the valve's best repeatability and response time.

The Bias function can be set to limit internally the minimum pressure reference independently from the external reference value thus optimizing valve's performances.

Refer to the programming manuals for a detailed description of other software selectable Bias functions.

### 11.5 Offset (Force)

The Offset function allows to calibrate the controlled force at zero reference signal to the specific hydraulic system setup (e.g. weight compensation with force control on vertical load).

Offset default setting is zero.

### 11.6 Ramps (Flow and Pressure/Force)

The ramp generator allows to convert sudden change of electronic reference signal into smooth time-dependent increasing/decreasing of the valve regulations.

Different ramp mode can be set:

- single ramp for any reference variation
- two ramps for increasing and for decreasing reference variations
- four ramps for positive/negative signal values and increasing/decreasing reference variations

Ramp generator is useful for application where smooth hydraulic actuation is necessary to avoid machine vibration and shocks.

If the proportional valve is driven by a closed loop controller, the ramps can lead to unstable behaviour, for these applications ramp function can be software disabled (default setting).

### 11.7 Linearization (Flow and Pressure/Force)

Linearization function allows to set the relation between the reference input signal and the controlled valve's regulations.

Linearization is useful for applications where it is required to linearize the valve's regulations in a defined working condition.

### 11.8 Dither (Flow and Pressure/Force)

The dither is an high frequency modulation added to the valve's reference signals to reduce the hysteresis of the valve's regulation; in fact a small vibration in the valve's hydraulic regulations considerably reduces the mechanical friction effects (e.g. due to cylinder seals).

Dither frequency and amplitude are software selectable; the amplitude is automatically reduced at high reference values (high regulated flow/pressure/force) to avoid possible instability.

Lower frequency and higher amplitude reduce hysteresis but also reduce the regulation stability. In some application this can lead to vibration and noise: right setting usually depends on system setup. Dither default setting is disabled.

### 11.9 Remote transducer scale (Pressure/Force)

Remote pressure/force transducer characteristics must be always selected to match the application requirements and obtain the best performances: transducer nominal range should be at least 115% ÷ 120% of the maximum regulated pressure/force.

Remote transducer scale function allows to set the transducer output signal value that correspond to the maximum regulated pressure/force.

### 11.10 Hydraulic configuration of 4 way valves (Pressure/Force)

The hydraulic configuration function allows to select:

with /SP option

- the valve's user port (A or B) where the pressure has to be controlled

with /SF, /SL option

- the valve/actuator connection (e.g. A or B valve's user port connected to the cylinder piston side)
- the force direction to be controlled with positive reference signal (push or pull)

#### 11.1-2 - Scale, Bias and Threshold(Flow)

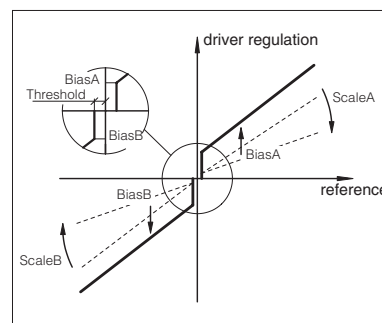

#### 11.1-3-5 - Scale and Offset (Flow/Force)

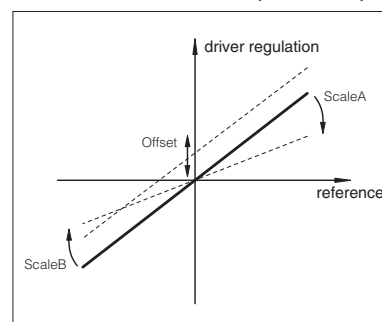

#### 11.1-4 - Scale and Bias (Pressure)

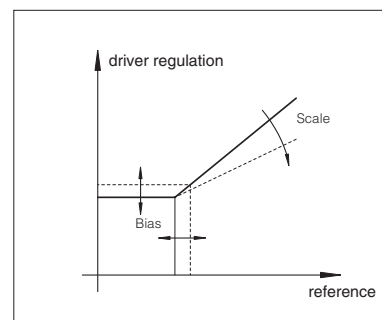

#### 11.6 - Ramps

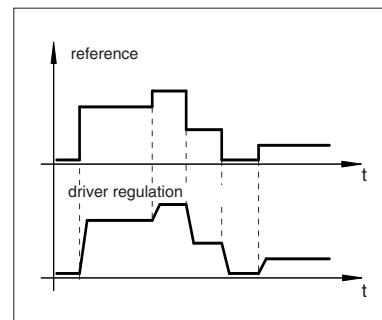

#### 11.7 - Linearization

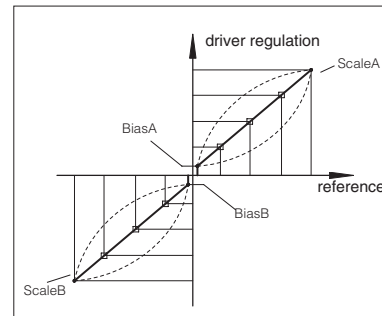

## 12 DRIVER CHARACTERISTICS

Power supply (1) (see 9.1, 9.5)	Nominal : +24 V <sub>DC</sub> Rectified and filtered : $V_{RMS} = 20 \div 32 V_{MAX}$ (ripple max 10 % $V_{PP}$ )
Max power consumption	50 W
Reference input signal (see 9.2)	Voltage: range $\pm 10 V_{DC}$ Input impedance: $R_i > 50 k\Omega$ Current: range $4 \div 20 mA$ Input impedance: $R_i = 316 \Omega$
Monitor output (see 9.3)	Output range :      voltage $\pm 10 V_{DC}$ @ max 5 mA current $4 \div 20 mA$ @ max 500 $\Omega$ load resistance
On-off inputs (see 9.4, 9.6)	Range : $0 \div 5 V_{DC}$ (OFF state), $9 \div 24 V_{DC}$ (ON state), $5 \div 9 V_{DC}$ (not accepted)      Input impedance: $R_i > 10 k\Omega$
Fault output (2) (see 9.7)	Output range : $0 \div 24 V_{DC}$ (ON state $> [power supply - 2 V]$ ; OFF state $< 1 V$ ) @ max 50 mA
Alarms	Solenoid coil not connected/short circuit, cable break with current reference signal, overtemperature, under temperature, valve spool trasducer cable break, pressure (force) transducer cable break
Format	Sealed box on the valve; IP67 protection degree
Operating temperature	$-20 \div 60 \text{ }^\circ\text{C}$ (storage $-20 \div 70 \text{ }^\circ\text{C}$ )
Mass	approx. 475 g
Additional characteristics	Short circuit protection of solenoid's current supply; spool position and pressure/force control by P.I.D. with rapid solenoid switching
Electromagnetic compatibility (EMC)	According to Directive 2004/108/CE (Immunity: EN 50082-2; Emission: EN 50081-2)
Communication interface	-PS Serial      -BC CANopen      -BP PROFIBUS
Physical Layer	serial RS232 (not insulated)      CAN ISO11898 (optical insulated)      RS485 (optical insulated)
Protocol	Atos ASCII coding      CANopen EN50325-4 + DS408      PROFIBUS DP EN50170-2/IEC61158
Recommended wiring cable	LiYCY shielded cables:      0,5 mm <sup>2</sup> for length up to 40 m [1,5 mm <sup>2</sup> for power supply and solenoid]

Notes: (1) nominal data for solenoid power stage and driver logic; (2) external negative voltage not allowed (e.g. due to inductive loads).

## 13 MAIN CONNECTOR CHARACTERISTICS (\*)

CODE	ZH-12P
Type	Female straight circular socket plug 12pin
Standard	DIN 43651
Material	Plastic reinforced with fiber glass
Cable gland	PG16
Cable	LiCY 10 x 0,14 mm <sup>2</sup> (signal) LiYY 3 x 1 mm <sup>2</sup> (alimantation)
Connection type	to crimp
Protection (DIN 60529)	IP 67

(\*) to be ordered separately

## 14 REMOTE TRANSDUCER(S) CONNECTOR CHARACTERISTICS (\*)

CODE	ZH-4P-M8/5	ZH-4P-M8-2/2
Type	Male straight circular socket plug 4 pin	Male straight circular socket plug 4 pin
Standard	M8 – IEC 60947-5-2	M8 – IEC 60947-5-2
Material	Plastic	Plastic
Cable gland	Connector moulded on cable 5 m lenght	Connector moulded on cable 2 m lenght
Cable	4 x 0,25 mm <sup>2</sup>	4 x 0,25 mm <sup>2</sup>
Connection type	cable	splitting cable
Protection (DIN 40050)	IP 67	IP 67

(\*) to be ordered separately

## 15 COMMUNICATION CONNECTOR CHARACTERISTICS (\*)

CODE	-PS Serial Connector ZH-5P	-BC CANopen Connector ZH-5P	-BP PROFIBUS DP Connector ZH-5P/BP
Type	Female straight circular socket plug 5 pin	Female straight circular socket plug 5 pin	Male straight circular socket plug 5 pin
Standard	M12 – IEC 60947-5-2	M12 – IEC 60947-5-2	M12 – IEC 60947-5-2
Material	Plastic	Plastic	Plastic
Cable gland	PG9	PG9	PG9
Cable	LiYCY 5 x 0,25 mm <sup>2</sup> shielded	CANBus Standard (DR303-1)	PROFIBUS DP Standard
Connection type	screw terminal	screw terminal	screw terminal
Protection (DIN 60529)	IP 67	IP 67	IP 67

(\*) to be ordered separately

## 16 OVERALL DIMENSIONS [mm]

