

Pressure relief valves type SAGAM

two stage, subplate mounting - ISO 6264 size 10, 20 and 32

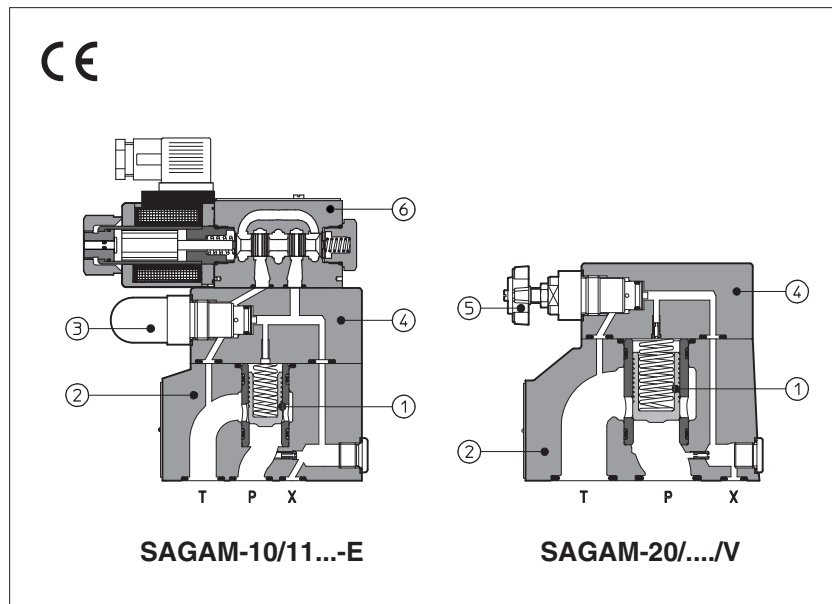

SAGAM are two stage pressure relief valves with balanced poppet, designed to operate in oil hydraulic systems.

In standard versions the piloting pressure of the poppet (1) of the main stage (2) is regulated by means of a grub screw protected by cap (3) in the cover (4).

Optional versions with setting adjustment by handwheel (5) instead of the grub screw are available on request.

Clockwise rotation increases the pressure.

SAGAM can be equipped with a SDHE pilot solenoid valve (6) for venting or for different pressure setting.

Mounting surface: **ISO 6264 size 10, 20 and 32**

Max flow: **200, 400 and 600 l/min**

Max pressure up to **350 bar**

1 MODEL CODE

SAGAM	-	20	/	10	/	210	/	100/100	V	-	E	X	24DC	**	/	*
<p>SAGAM = pressure relief valve subplate mounting</p> <p>Size: 10 20 32</p> <p>Setting pressure and venting option: - = one setting pressure without option 10 = one setting pressure with venting, with de-energized solenoid 11 = one setting pressure with venting, with energized solenoid 20 = two setting pressure with venting, with de-energized solenoid 21 = two setting pressure with venting, with energized solenoid 22 = two setting pressure without venting 32 = three setting pressure without venting</p> <p>Setting: see section 4 for available setting</p> <p>Pressure range of second/third setting (1): 50 = 4÷50 bar 100 = 6÷100 bar 210 = 7÷210 bar 350 = 8÷350 bar</p> <p>Options, see section 7 E V WP Y</p> <p>X = without connector (1): See section 10 for available connectors, to be ordered separately -00-AC = AC solenoid valve without coils -00-DC = DC solenoid valve without coils</p> <p>Solenoid venting valve (1): E = SDHE for AC and DC supply, with cURus certified solenoids L = SDHL for AC and DC supply, compact execution</p> <p>Seals material, see section 11: - = NBR PE = FKM BT = HNBR</p> <p>Series number</p> <p>Voltage code, see section 6 (1):</p>																

(1) Only for SAGAM with solenoid valve for venting and/or for the selection of the setting pressure

2 HYDRAULIC SYMBOLS

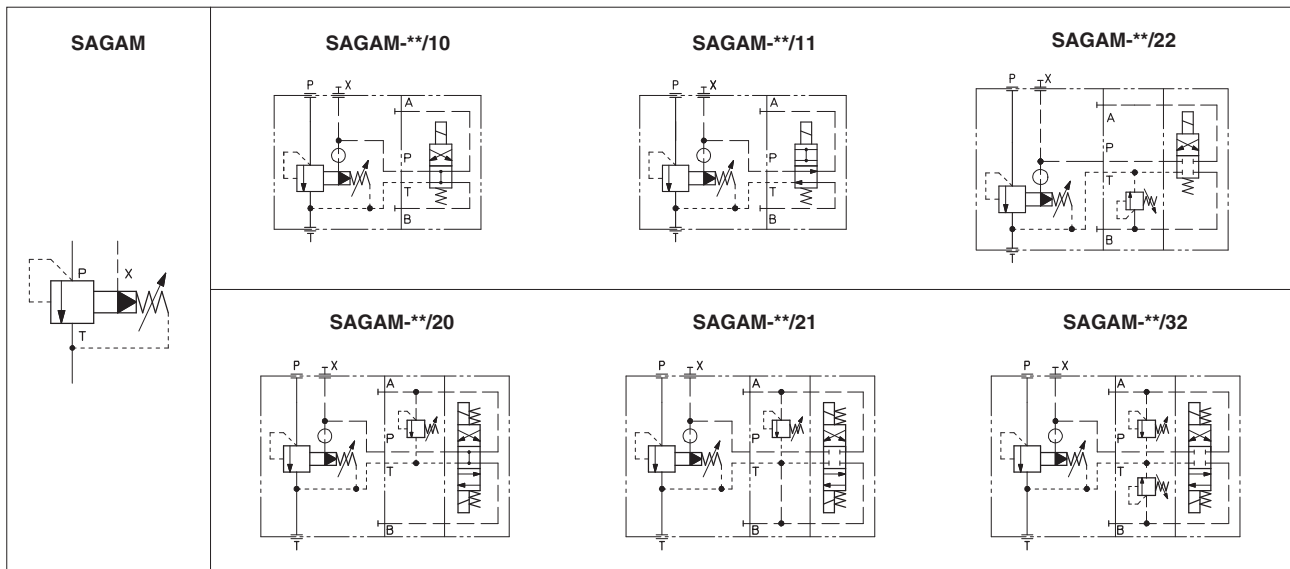

3 GENERAL CHARACTERISTICS

Assembly position	Any position	
Subplate surface finishing to ISO 4401	Acceptable roughness index, $R_a \leq 0,8$ recommended $R_a 0,4$ - flatness ratio 0,01/100	
MTTFd valves according to EN ISO 13849	75 years	
Ambient temperature range	Standard = $-30^\circ\text{C} \div +70^\circ\text{C}$ / PE option = $-20^\circ\text{C} \div +70^\circ\text{C}$ / BT option = $-40^\circ\text{C} \div +70^\circ\text{C}$	
Storage temperature range	Standard = $-30^\circ\text{C} \div +80^\circ\text{C}$ / PE option = $-20^\circ\text{C} \div +80^\circ\text{C}$ / BT option = $-40^\circ\text{C} \div +80^\circ\text{C}$	
Surface protection	Body: zinc coating with black passivation	Coil: zinc nickel coating (DC version) plastic incapsulation (AC version)
Corrosion resistance	Salt spray test (EN ISO 9227) > 200 h	

4 HYDRAULIC CHARACTERISTICS

Valve model	SAGAM-10	SAGAM-20	SAGAM-32
Setting [bar]	50;	100; 210;	350
Pressure range [bar]	4÷50;	6÷100; 7÷210;	8÷350
Max pressure [bar]	Ports P, X = 350 Ports T, Y = 210 (without pilot solenoid valve) For version with pilot solenoid valve, see technical tables E015 and E018		
Max flow [l/min]	200	400	600

5 ELECTRICAL CHARACTERISTICS (for SAGAM with pilot solenoid valve)

Insulation class	H (180°C) for DC coils; F (155°C) for AC coils Due to the occurring surface temperatures of the solenoid coils, the European standards EN ISO 13732-1 and EN ISO 4413 must be taken into account
Protection degree to DIN EN 60529	IP 65 (with connectors correctly assembled)
Relative duty factor	100%
Supply voltage and frequency	See section 6
Supply voltage tolerance	$\pm 10\%$
Certification	cURus North American standard - only for SDHE pilot valve

6 COIL VOLTAGE

External supply nominal voltage ± 10%	Voltage code	Type of connector	-EX Power consumption (2)	-LX Power consumption (2)	Code of spare coil -EX	Code of spare coil -LX
12 DC	12 DC	666 or 667	30W	29W	COE-12DC	COL-12DC
14 DC	14 DC				COE-14DC	COL-14DC
110 DC	110 DC				COE-110DC	COL-110DC
220 DC	220 DC				COE-220DC	COL-220DC
110/50 AC (1)	110/50/60 AC	666 or 667	58VA (3)	58VA (3)	COE-110/50/60AC	COL-110/50/60AC
230/50 AC (1)	230/50/60 AC		58VA (3)		COE-230/50/60AC	COL-230/50/60AC

For other supply voltages available on request see technical tables E015, E018.

(1) Coil can be supplied also with 60 Hz of voltage frequency: in this case the performances are reduced by 10 ÷ 15% and the power consumption is 55 VA (SDHL) and 58 VA (SDHE)

(2) Average values based on tests performed at nominal hydraulic condition and ambient/coil temperature of 20°C.

(3) When solenoid is energized, the inrush current is approx 3 times the holding current.

7 OPTIONS

/E = external pilot

/V = regulating handwheel instead of grub screw protected by cap

/WP = prolonged manual override protected by rubber cap (only for SAGAM with pilot solenoid valve)

/Y = external drain (only for SAGAM with pilot solenoid valve)

8 REGULATED PRESSURE VERSUS FLOW DIAGRAMS based on mineral oil ISO VG 46 at 50°C

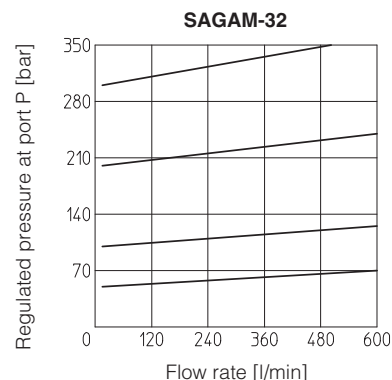
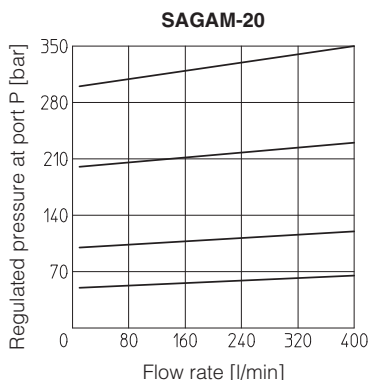
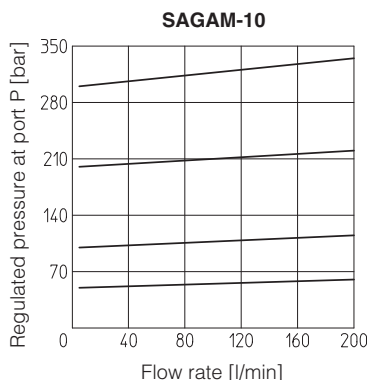

9 MINIMUM PRESSURE VERSUS FLOW DIAGRAMS based on mineral oil ISO VG 46 at 50°C

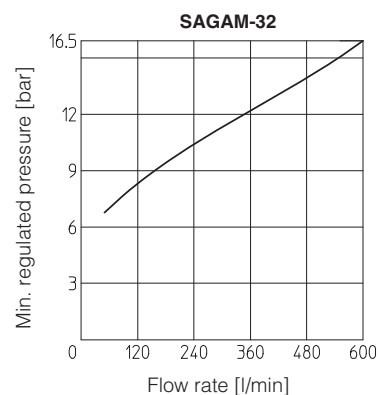
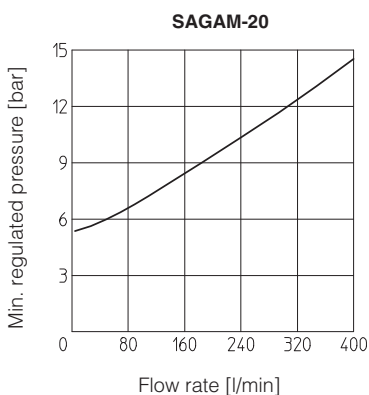
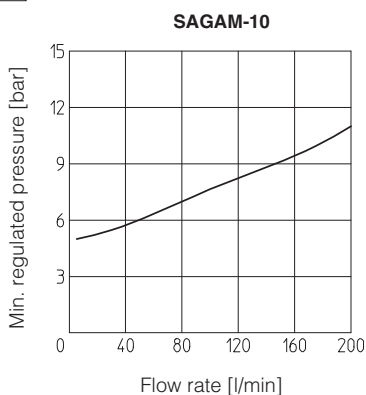

10 ELECTRIC CONNECTORS ACCORDING TO DIN 43650 FOR SAGAM WITH SOLENOID VALVE

The connectors must be ordered separately

Code of connector	Function
666	Connector IP-65, suitable for direct connection to electric supply source
667	As 666 connector IP-65 but with built-in signal led, suitable for direct connection to electric supply source

11 SEALS AND HYDRAULIC FLUID - for other fluids not included in below table, consult our technical office

Seals, recommended fluid temperature	NBR seals (standard) = -20°C ÷ +80°C, with HFC hydraulic fluids = -20°C ÷ +50°C FKM seals (/PE option) = -20°C ÷ +80°C HNBR seals (/BT option) = -40°C ÷ +60°C, with HFC hydraulic fluids = -40°C ÷ +50°C		
Recommended viscosity	15 ÷ 100 mm ² /s - max allowed range 2,8 ÷ 500 mm ² /s		
Max fluid contamination level	ISO4406 class 20/18/15 NAS1638 class 9, see also filter section at www.atos.com or KTF catalog		
Hydraulic fluid	Suitable seals type	Classification	Ref. Standard
Mineral oils	NBR, FKM, HNBR	HL, HLP, HLPD, HVLP, HVLPD	DIN 51524
Flame resistant without water	FKM	HFDU, HFDR	ISO 12922
Flame resistant with water	NBR, HNBR	HFC	

12 DIMENSIONS [mm]

SAGAM-10

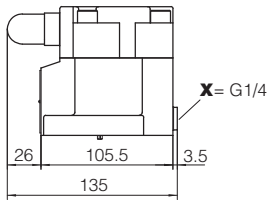

Mass: 3,6 Kg

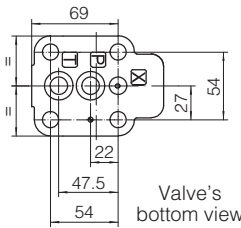
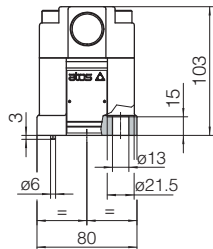

Valve's bottom view

ISO 6264: 2007

Mounting surface: 6264-06-09-1-97

Fastening bolts:
4 socket head screws
M12x35 class 12.9
Tightening torque = 125 Nm
Seals: 2 OR 123; 1 OR 109/70
Ports P, T: Ø = 14,5 mm
Ports X: Ø = 3,2 mm

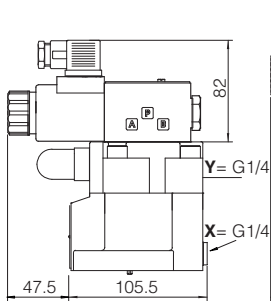

SAGAM-10/10/-EX
SAGAM-10/11/**-EX**

Mass: 5,1 Kg

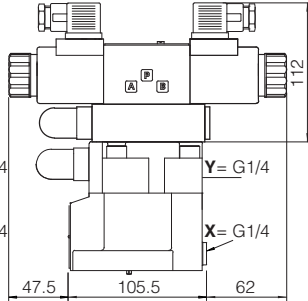

SAGAM-10/20/-EX
SAGAM-10/21/**-EX**

Mass: 6,2 Kg

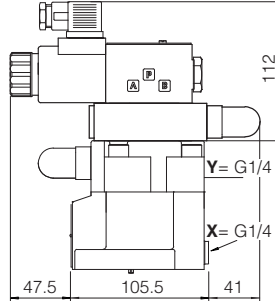

SAGAM-10/22/-EX**

Mass: 5,9 Kg

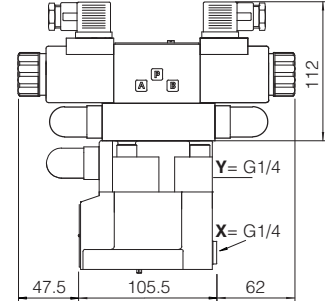

SAGAM-10/32/-EX**

Mass: 6,3 Kg

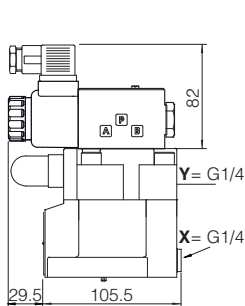

SAGAM-10/10/-LX
SAGAM-10/11/**-LX**

Mass: 4,8 Kg

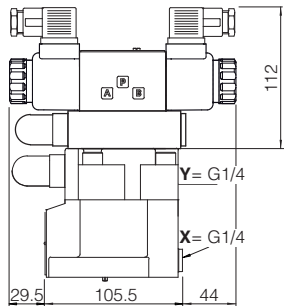

SAGAM-10/20/-LX
SAGAM-10/21/**-LX**

Mass: 5,6 Kg

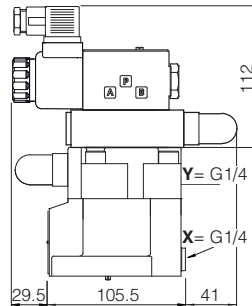

SAGAM-10/22/-LX**

Mass: 5,6 Kg

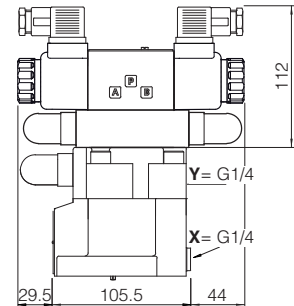

SAGAM-10/32/-LX**

Mass: 5,7 Kg

Overall dimensions refer to valves **DC** voltage, with connectors type 666

SAGAM-20

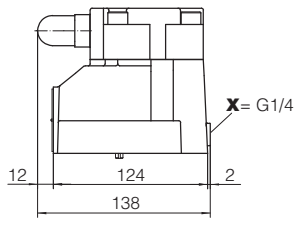

Mass: 4,8Kg

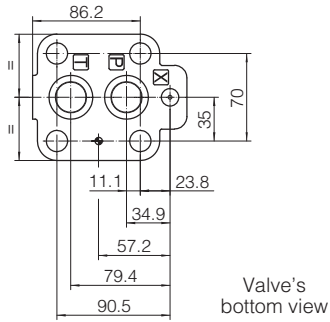
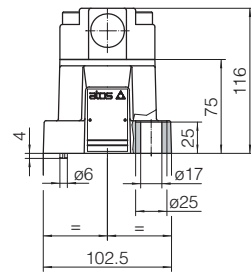

Valve's bottom view

ISO 6264: 2007

Mounting surface: 6264-08-11-1-97

Fastening bolts:

4 socket head screws M16x50 class 12.9

Tightening torque = 300 Nm

Seals: 2 OR 4112; 1 OR 109/70

Ports P, T: $\varnothing = 24$ mm

Ports X: $\varnothing = 3,2$ mm

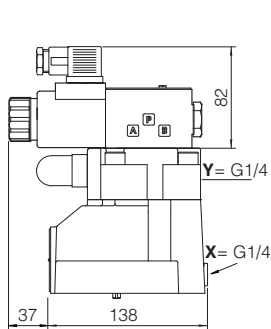

SAGAM-20/10/-EX
SAGAM-20/11/**-EX**

Mass: 6,3 Kg

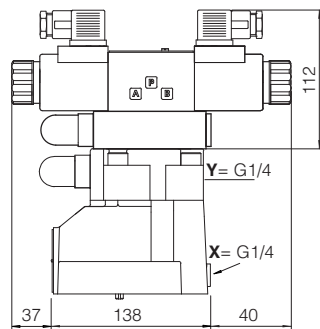

SAGAM-20/20/-EX
SAGAM-20/21/**-EX**

Mass: 7,4 Kg

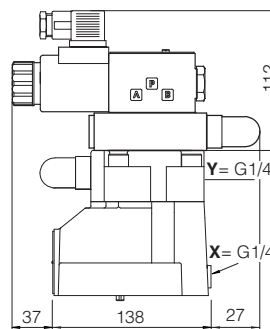

SAGAM-20/22/-EX**

Mass: 7,1 Kg

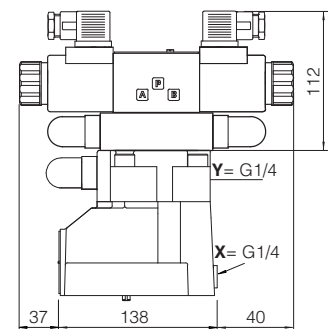

SAGAM-20/32/-EX**

Mass: 7,5 Kg

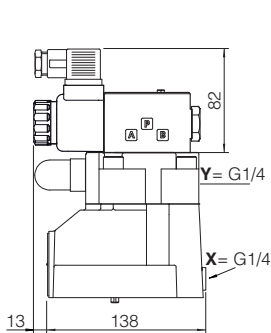

SAGAM-20/10/-LX
SAGAM-20/11/**-LX**

Mass: 6 Kg

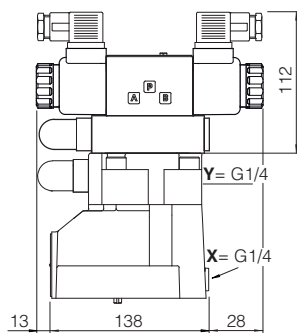

SAGAM-20/20/-LX
SAGAM-20/21/**-LX**

Mass: 6,8Kg

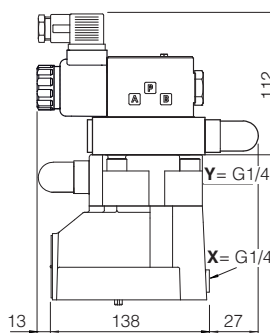

SAGAM-20/22/-LX**

Mass: 6,8 Kg

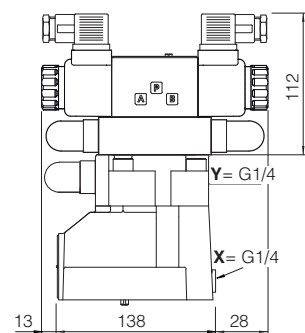

SAGAM-20/32/-LX**

Mass: 7 Kg

SAGAM-32

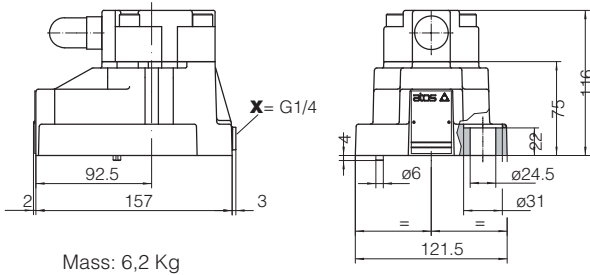

Mass: 6,2 Kg

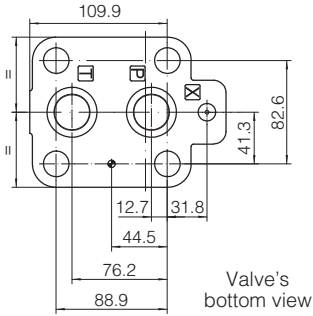

Valve's bottom view

ISO 6264: 2007

**Mounting surface: 6264-10-17-1-97
(with M20 fixing holes instead of standard M18)**

Fastening bolts:

4 socket head screws M20x60 class 12.9

Tightening torque = 600 Nm

Seals: 2 OR 4131; 1 OR 109/70

Ports P, T: $\phi = 28,5$ mm

Ports X: $\phi = 3,2$ mm

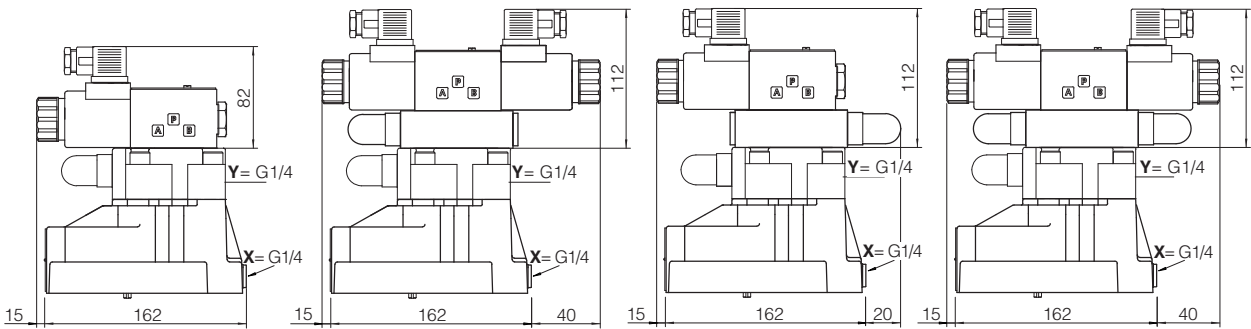

SAGAM-32/10/-EX
SAGAM-32/11/**-EX**

Mass: 7,7 Kg

SAGAM-32/20/-EX
SAGAM-32/21/**-EX**

Mass: 8,8 Kg

SAGAM-32/22/-EX**

Mass: 8,5 Kg

SAGAM-32/32/-EX**

Mass: 8,9 Kg

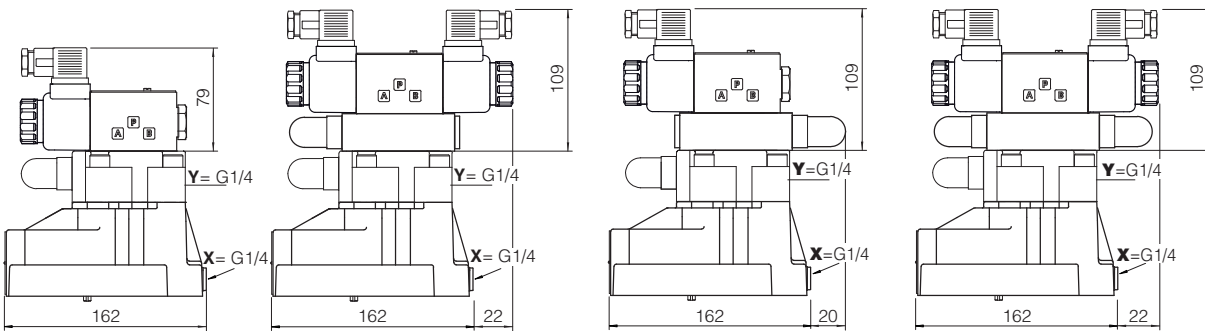

SAGAM-32/10/-LX
SAGAM-32/11/**-LX**

Mass: 7,4 Kg

SAGAM-32/20/-LX
SAGAM-32/21/**-LX**

Mass: 8,2 Kg

SAGAM-32/22/-LX**

Mass: 8,2 Kg

SAGAM-32/32/-LX**

Mass: 8,4 Kg

Overall dimensions refer to valves **DC** voltage, with connectors type 666