

# Solenoid directional valves type **SDHE**

direct, spool type, high flow

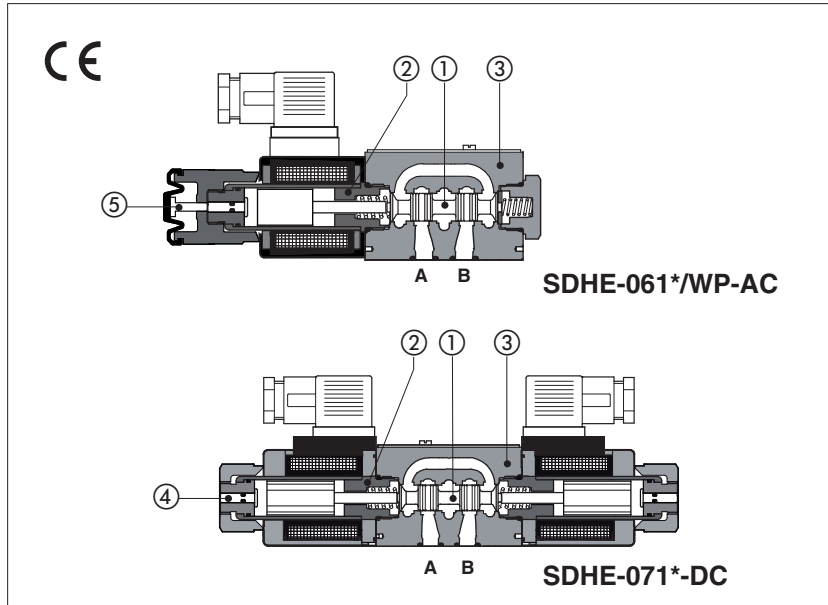

Spool type, two or three position direct operated valves with high performance threaded solenoids certified according the North American standard **cURus**.

Solenoids ② are made by:

- wet type screwed tube, different for AC and DC power supply, with integrated manual override pin ④
- interchangeable coils, specific for AC or DC power supply, easily replaceable without tools - see section ④ for available voltages

Standard coils protection **IP65** optional coils with IP67 AMP Junior Timer, Deutsch or lead wire connections.

Wide range of interchangeable spools ①, see section ②.

The valve body ③ is 3 chamber type made by shell-moulding casting with wide internal passages ensuring low pressure drops.

Mounting surface: **ISO 4401 size 06**

Max flow: **80 l/min**

Max pressure: **350 bar**

## 1 MODEL CODE

<b>SDHE - 0</b>	<b>61</b>	<b>1</b>	<b>/A</b> -	<b>X</b>	<b>24 DC</b>	<b>**</b>	<b>/*</b>
Directional control valves size 06						Series number	Seals material, see section ③: - = NBR <b>PE</b> = FKM <b>BT</b> = NBR low temp.
<p>Valve configuration, see section ②</p> <p><b>61</b> = single solenoid, center plus external position, spring centered  <b>63</b> = single solenoid, 2 external positions, spring offset  <b>67</b> = single solenoid, center plus external position, spring offset  <b>70</b> = double solenoid, 2 external positions, without spring  <b>71</b> = double solenoid, 3 positions, spring centered  <b>75</b> = double solenoid, 2 external positions, with detent</p> <p>Spool type, see section ②.</p> <p>Options: <b>A, MO, MV, WP, L*</b>, see section ⑥.</p>							
Voltage code, see section ④						<p><b>00-AC</b> = AC solenoids without coils  <b>00-DC</b> = DC solenoids without coils  <b>X</b> = without connector                  See section ③ for available connectors, to be ordered separately                  Coils with special connectors, see section ②  <b>XJ</b> = AMP Junior Timer connector  <b>XK</b> = Deutsch connector  <b>XS</b> = Lead Wire connection</p>	

## 2 CONFIGURATIONS and SPOOLS (representation according to ISO 1219-1)

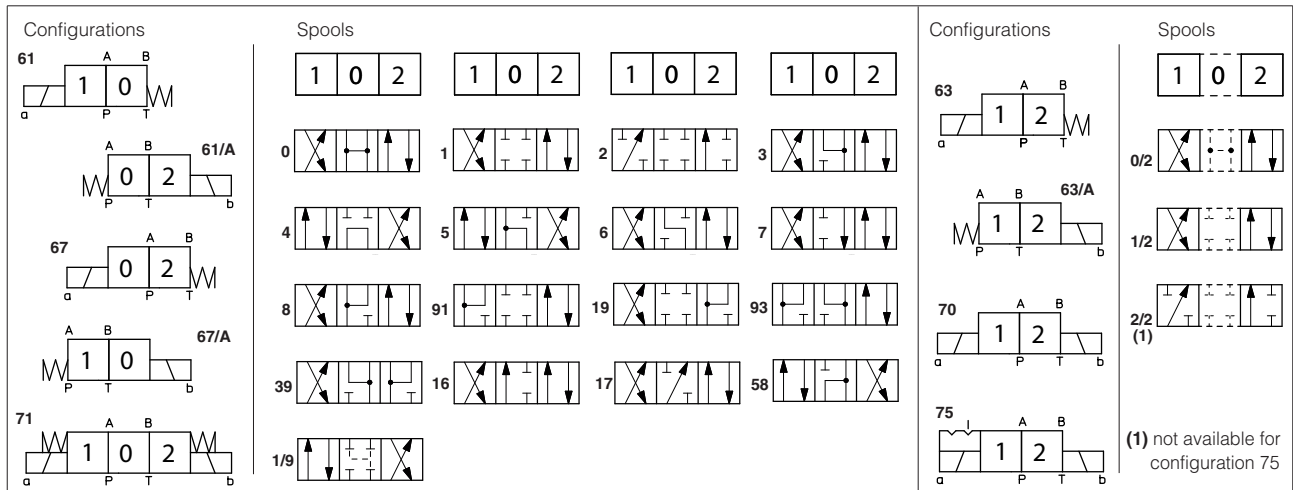

### 2.1 Special spools

- spools type **0** and **3** are also available as **0/1** and **3/1** with restricted oil passages in central position, from user ports to tank.
- spools type **1, 4, 5** and **58** are also available as **1/1, 4/8, 5/1** and **58/1**. They are properly shaped to reduce water-hammer shocks during the switching.
- spools type **1, 1/2, 3, 8** are available as **1P, 1/2P, 3P, 8P** to limit valve internal leakages.
- Other types of spools can be supplied on request.

### 3 MAIN CHARACTERISTICS

Assembly position / location	Any position
Subplate surface finishing	Roughness index Ra 0,4 - flatness ratio 0,01/100 (ISO 1101)
MTTFd values according to EN ISO 13849	150 years, for further details see technical table P007
Ambient temperature	<b>Standard</b> = -30°C ÷ +70°C <b>/PE</b> option = -20°C ÷ +70°C <b>/BT</b> option = -40°C ÷ +70°C
Flow direction	As shown in the symbols of table 2
<b>Operating pressure</b>	Ports P,A,B: <b>350</b> bar; Port T <b>210</b> bar for DC version; <b>160</b> bar for AC version
<b>Maximum flow</b>	<b>80 l/min</b> , see operating limits at section 8

#### 3.1 Coils characteristics

Insulation class	<b>H</b> (180°C) for DC coils; <b>F</b> (155°C) for AC coils Due to the occurring surface temperatures of the solenoid coils, the European standards EN ISO 13732-1 and EN ISO 4413 must be taken into account
Protection degree to DIN EN 60529	<b>IP 65</b> (with connectors 666, 667, 669 correctly assembled)
Relative duty factor	100%
Supply voltage and frequency	See coil voltage 5
Supply voltage tolerance	± 10%
Certification	<b>cURus</b> North American Standard

### 4 SEALS AND HYDRAULIC FLUID - for other fluids not included in below table, consult our technical office

Seals, recommended fluid temperature	NBR seals (standard) = -20°C ÷ +80°C, with HFC hydraulic fluids = -20°C ÷ +50°C FKM seals (/PE option) = -20°C ÷ +80°C NBR low temp. (/BT option) = -40°C ÷ +50°C		
Recommended viscosity	15 ÷ 100 mm <sup>2</sup> /s - max allowed range 2,8 ÷ 500 mm <sup>2</sup> /s		
Max fluid contamination level	ISO4406 class 20/18/15 NAS1638 class 9, see also filter section at www.atos.com or KTF catalog		
<b>Hydraulic fluid</b>	<b>Suitable seals type</b>	<b>Classification</b>	<b>Ref. Standard</b>
Mineral oils	NBR, FKM, NBR low temp.	HL, HLP, HLPD, HVLP, HVLPD	DIN 51524
Flame resistant without water	FKM	HFDU, HFDR	ISO 12922
Flame resistant with water	NBR, NBR low temp.	HFC	

### 5 COIL VOLTAGE

External supply nominal voltage ± 10%	Voltage code	Type of connector	Power consumption (2)	Code of spare coil
12 DC	<b>12 DC</b>	666 or 667	30 W	COE-12DC
14 DC	<b>14 DC</b>			COE-14DC
24 DC	<b>24 DC</b>			COE-24DC
28 DC	<b>28 DC</b>			COE-28DC
110 DC	<b>110 DC</b>			COE-110DC
220 DC	<b>220 DC</b>			COE-220DC
110/50 AC	<b>110/50/60 AC</b>	669	58 VA (3)	COE-110/50/60AC
230/50 AC	<b>230/50/60 AC</b>			COE-230/50/60AC
110/50 AC (1)	<b>110/50/60 AC</b>	669	30 W	COE-110RC
230/50 AC (1)	<b>230/50/60 AC</b>			COE-230RC

(1) Coil can be supplied also with 60 Hz of voltage frequency: in this case the performances are reduced by 10 ÷ 15% and the power consumption is 52 VA.

(2) Average values based on tests performed at nominal hydraulic condition and ambient/coil temperature of 20°C.

(3) When solenoid is energized, the inrush current is approx 3 times the holding current.

### 6 OPTIONS

**A** = Solenoid mounted at side of port B (only for single solenoid valves). In standard versions, solenoid is mounted at side of port A.

**MV, MO** = auxiliary hand lever positioned vertically (MV) or horizontally (MO).

Available for configuration: **61 - 63 - 71**, spools: **0 - 0/2 - 1 - 1P - 1/2 - 1/2P - 3 - 3P - 4 - 7**

**WP** = prolonged manual override protected by rubber cap.

**L1, L2, L3** = (only for SDHE-DC) device for switching time control, installed in the valve solenoid.

For spools 4 and 4/8 only device L3 is available.

#### 6.1 Accessories

**WPD/SHE** = (only for SDHE-**DC**) manual override with detent, to be ordered separately, see section 15



The manual override operation can be possible only if the pressure at T port is lower than 50 bar

**7 Q/ΔP DIAGRAMS** based on mineral oil ISO VG 46 at 50°C

Spool type	Flow direction				
	P→A	P→B	A→T	B→T	P→T
0, 0/1	A	A	C	C	D
1, 1/1, 1/9	D	C	C	C	
3, 3/1	D	D	A	A	
4, 4/8, 5, 5/1, 58, 58/1	F	F	G	C	E
1/2, 0/2	D	D	D	D	
6, 7, 16, 17	D	D	D	D	
8	A	A	E	E	
2	D	D			
2/2	F	F			
19, 91	E	E	D	D	
39, 93	F	F	G	G	

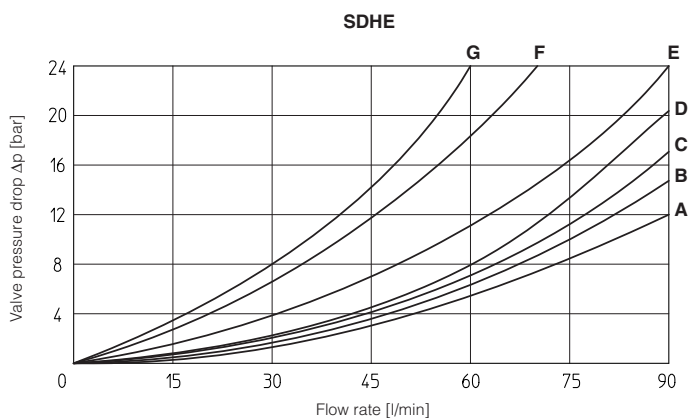

**8 OPERATING LIMITS** based on mineral oil ISO VG 46 at 50°C

The diagrams have been obtained with warm solenoids and power supply at lowest value ( $V_{nom} - 10\%$ ). The curves refer to application with symmetrical flow through the valve (i.e. P→A and B→T). In case of asymmetric flow and if the valves have the devices for controlling the switching times the operating limits must be reduced.

Curve	DC version, spool type:
A	0, 0/1, 1, 1/2, 3, 8
B	0/2, 1/1, 6, 7, 1/9, 19
C	3/1, 4, 4/8, 5, 5/1, 16, 17, 19, 39, 58, 58/1, 91, 93
D	2, 2/2

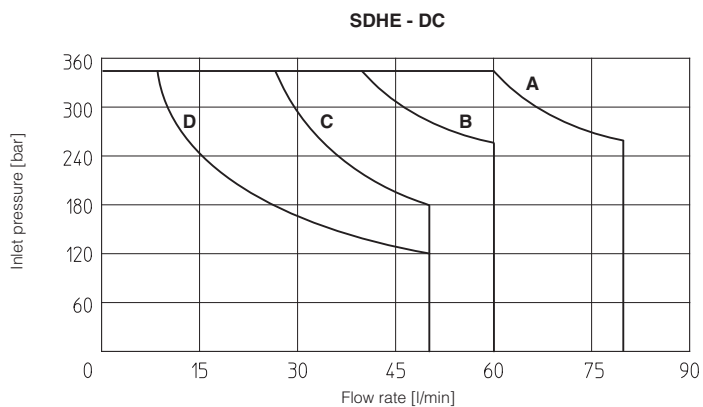

Curve	AC version, spool type:
A	1, 1/2, 8
B	0, 0/1, 0/2, 1/1, 1/9, 3
C	3, 3/1, 6, 7
D	4, 4/8, 5, 5/1, 16, 17, 19, 39, 58, 58/1, 91, 93
E	2, 2/2

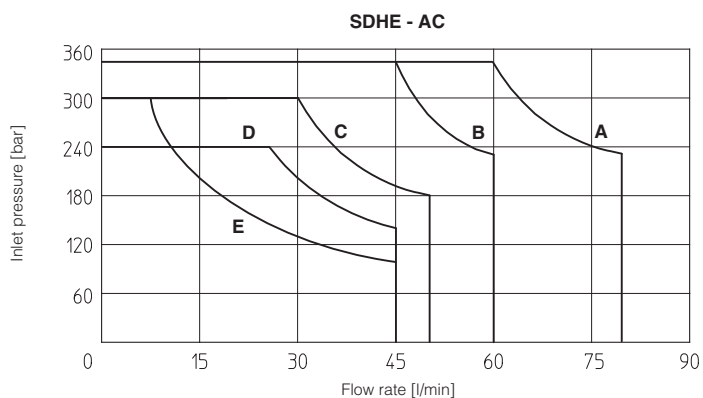

**9 SWITCHING TIMES** (average values in msec)

Test conditions: - 36 l/min; 150 bar  
 - nominal voltage  
 - 2 bar of counter pressure on port T  
 - mineral oil: ISO VG 46 at 50°C

The elasticity of the hydraulic circuit and the variations of the hydraulic characteristics and temperature affect the response time.

Valve	Switch-on AC	Switch-off AC	Switch-on DC	Switch-off DC
SDHE	10 - 25	20 - 40	30 - 50	15 - 25
SDHE-*/L1	—	—	60	60
SDHE-*/L2	—	—	80	80
SDHE-*/L3	—	—	150	150

**10 SWITCHING FREQUENCY**

Valve	AC (cycles/h)	DC (cycles/h)
SDHE + 666 / 667	7200	15000

**11 ELECTRIC CONNECTORS ACCORDING TO DIN 43650** (to be ordered separately)

666, 667 (for AC or DC supply)		669 (for AC supply)		CONNECTOR WIRING		
				<b>666, 667</b> 1 = Positive ⊕ 2 = Negative ⊖ ⊕ = Coil ground		<b>669</b> 1,2 = Supply voltage V <sub>AC</sub> 3 = Coil ground
<b>SUPPLY VOLTAGES</b>						
<b>666</b> All voltages		<b>667</b> 24 AC or DC 110 AC or DC 220 AC or DC		<b>669</b> 110/50 AC 110/60 AC 230/50 AC 230/60 AC		

**12 COIL WITH SPECIAL CONNECTORS** only for voltage supply 12, 14, 24, 28 Vdc

AMP Junior timer connector	Deutsch connector DT-04-2P	Lead Wire connection
<p><b>Options -XJ</b>                      Coil type COEJ                      AMP Junior Timer connector                      Protection degree <b>IP67</b></p>	<p><b>Options -XK</b>                      Coil type COEK                      Deutsch connector                      DT-04-2P male                      Protection degree <b>IP67</b></p>	<p><b>Options -XS</b>                      Coil type COES                      Lead Wire connection                      Cable length = 180 mm</p>

Note: for the electric characteristics refer to standard coils features - see section 5

**13 PLUG-IN RESTRICTOR** (to be ordered separately)

The use of plug-in restrictors in valve's ports P or A or B may be necessary in case of particular conditions as long flexible hoses or the presence of accumulators which could cause at the valve switching instantaneous high flow peaks over the max valve's operating limits.

Ordering code:

<b>PLUG H</b>	-	<b>**</b>
<b>08, 10, 12, 15</b> calibrated orifice diameter in tenths of mm Example PLUG-H-12 = orifice diameter <b>1,2 mm</b> Other orifice dimensions are available on request		

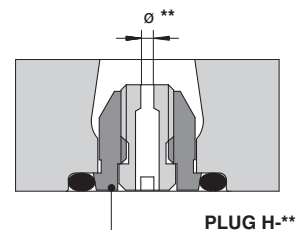

14 DIMENSIONS [mm]

ISO 4401: 2005

Mounting surface: 4401-03-02-0-05

Fastening bolts: 4 socket head screws:

M5x30 class 12.9

Tightening torque = 8 Nm

Seals: 4 OR 108

Ports P,A,B,T:  $\varnothing = 7.5$  mm (max)

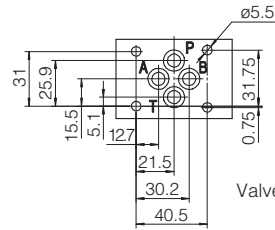

Valve's bottom view

**P** = PRESSURE PORT  
**A, B** = USE PORT  
**T** = TANK PORT

**SDHE-06(DC)**

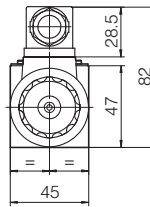
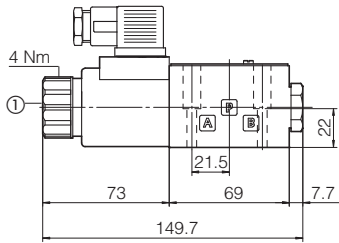

Mass: 1,5 kg

**SDHE-06\*A(DC)**

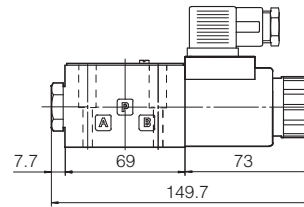

**SDHE-07(DC)**

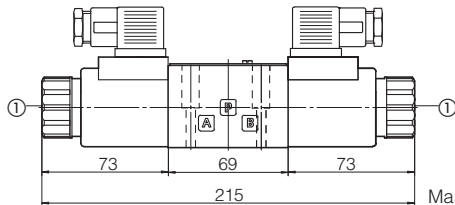

Mass: 2 kg

**SDHE-06(AC)**

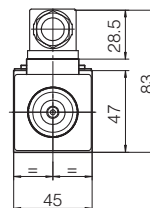
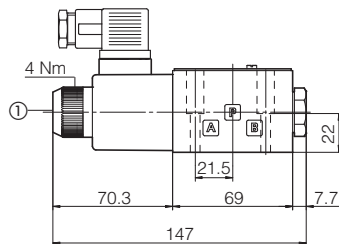

Mass: 1,4 kg

**SDHE-07\*A(AC)**

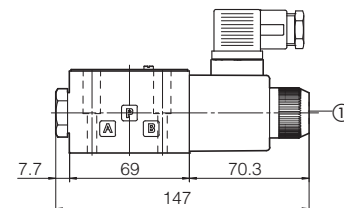

**SDHE-07(AC)**

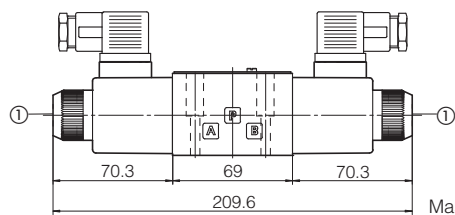

Mass: 1,8 kg

① Standard manual override PIN

Overall dimensions are referred to valves with connector 666

⚠ The manual override operation can be possible only if the pressure at T ports is lower than 50 bar

**DC Solenoids**

**AC Solenoid**

**STD**  
execution

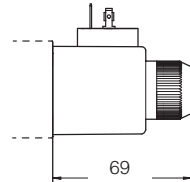
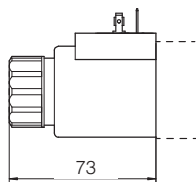

option / **WP**

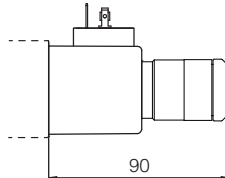
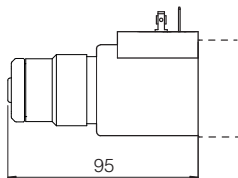

**WPD/SHE**  
to be ordered  
separately

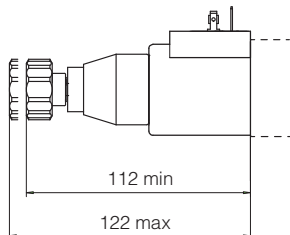

Not available  
for AC version

option / **MV**

Mass:  
+ 0,9 kg

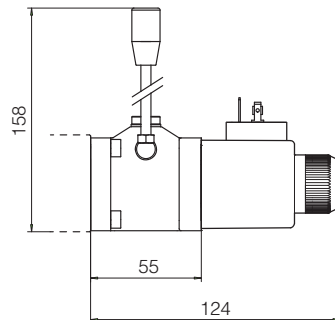
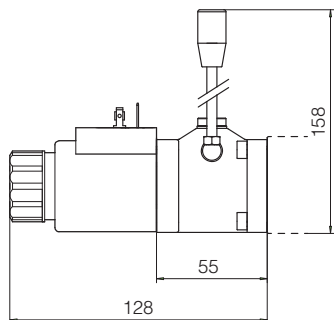

option / **MO**

Mass:  
+ 0,9 kg

