

# Solenoid directional valves type DHER

direct operated, ISO 4401 size 06

**obsolete components - availability on request**

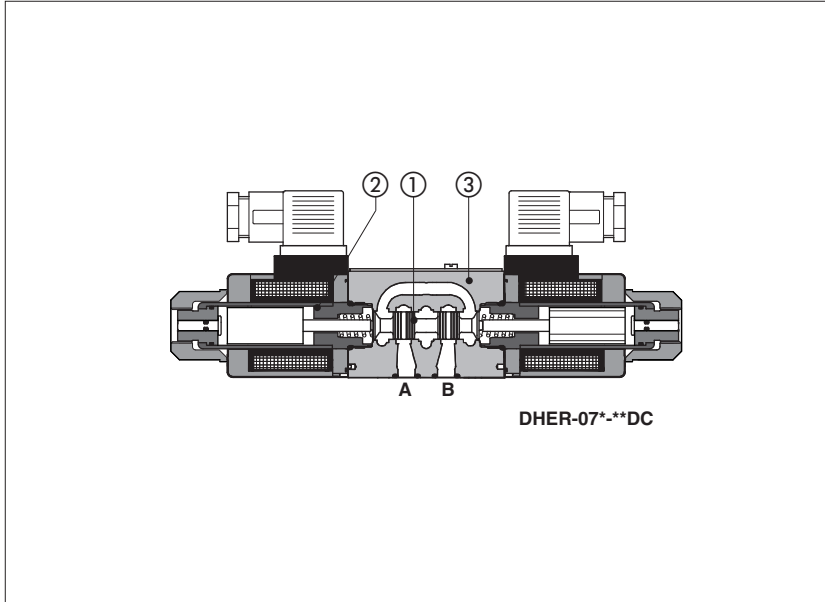

Spool type, direct operated solenoid valves equipped with threaded type, high performance solenoids certified according to the North American standard **cURus**

### Configurations and construction

The valves are available in three or four way configurations and with two or three spool positions. The spools ① are interchangeable and they are available in a wide range of hydraulic configurations, see section ②. The solenoids ② have two different executions for AC or DC power supply and they are composed by:

- wet type screwed tube with integrated manual override pin d (the tube are different for AC and DC power supply).
- AC and DC coils see section ⑤

The coils are interchangeable for the same type of power supply AC or DC and they can be easily replaced without tools.

The coils are fully encapsulated with the following temperature classes:

- class H for DC coils
- class F for AC coils

The valve body ③ is 3 chamber type made by shell-moulding casting.

### Options

The following optional devices are available for DHER:

- prolonged manual override protected with rubber cap for easy hand operation
- control devices of the valve switching time
- spool position monitor devices for safety applications

**Surface mounting ISO 4401 size 06.**

**Max flow up to 80 l/min**

**Max pressure: 350 bar**

## 1 MODEL CODE

**DHER - 0 63 1/2 /A - X 24 DC \*\* \*/\***

Directional control valves size 06

Valve configuration, see table ②

- 61** = single solenoid, center plus external position, spring centered
- 63** = single solenoid, 2 external positions, spring offset
- 67** = single solenoid, center plus external position, spring offset
- 71** = double solenoid, 3 positions, spring centered
- 75** = double solenoid, 2 external positions, with detent

Spool type, see table ②

Options, see note 1 at section ④

Seals material:  
omit for NBR (mineral oil & water glycol)  
**PE** = FPM

Series number

Voltage code, see section ⑤

**00-AC** = AC solenoids without coils  
**00-DC** = DC solenoids without coils

**X** = without connector

See note 2 at section ④ for available connectors, to be ordered separately

Coils with special connectors, see sect. ⑥

**XJ** = AMP Junior Timer connector

**XK** = Deutsch connector

**XS** = Lead Wire connection

## 2 CONFIGURATIONS and SPOOLS

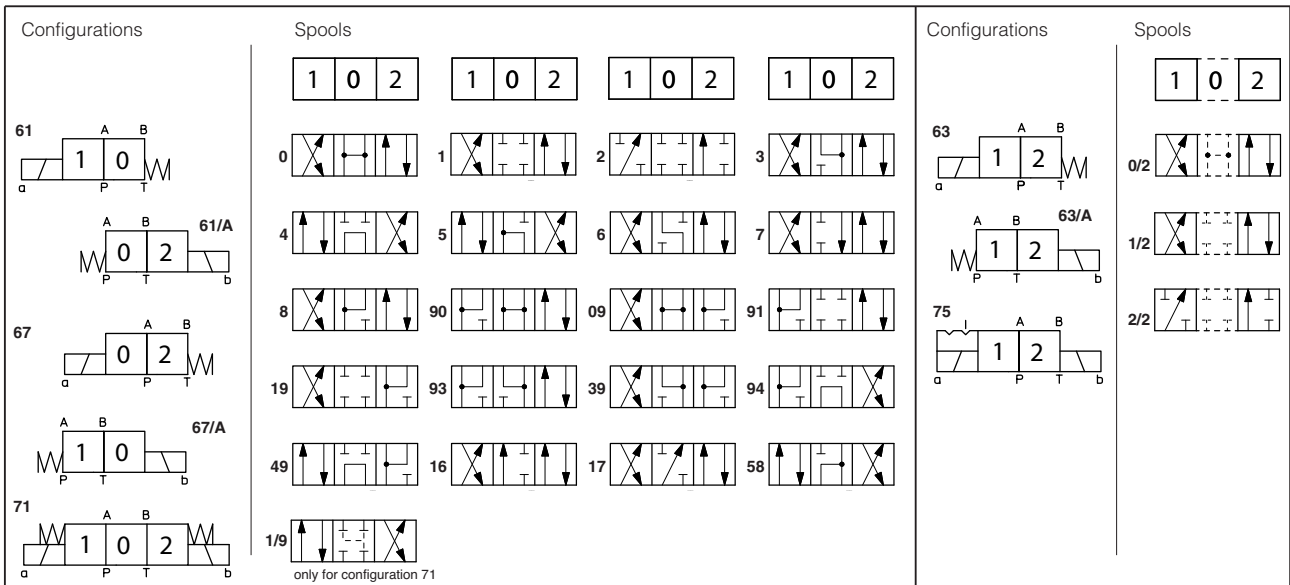

### 3 MAIN CHARACTERISTICS OF DHE\* DIRECTIONAL VALVES

Assembly position / location	Any position
Subplate surface finishing	Roughness index Ra 0,4 - flatness ratio 0,01/100 (ISO 1101)
Ambient temperature	from -20°C to +70°C
Fluid	Hydraulic oil as per DIN 51524 .... 535; for other fluids see section 11
Recommended viscosity	15 ÷ 100 mm <sup>2</sup> /s at 40°C (ISO VG 15 ÷ 100)
Fluid contamination class	ISO 4406 class 21/19/16 NAS 1638 class 10, in line filters of 25 µm (β <sub>25</sub> ≥ 75 recommended)
Fluid temperature	-20°C +60°C (standard seals) -20°C +80°C (IPE seals)
Flow direction	As shown in the symbols of table 2
<b>Operating pressure</b>	Ports P,A,B: <b>350 bar</b> ; Port T <b>210 bar</b> for DC version; <b>160 bar</b> for AC version
Rated flow	See diagrams Q/Δp at section 7
<b>Maximum flow</b>	<b>80 l/min</b> , see operating limits at section 8

#### 3.1 Coils characteristics

Insulation class	<b>H</b> (180°C) for DC coils <b>F</b> (155°C) for AC coils Due to the occurring surface temperatures of the solenoid coils, the European standards EN ISO 13732-1 and EN ISO 4413 must be taken into account
Connector protection degree DIN 43650	IP 65
Relative duty factor	100%
Supply voltage and frequency	See electric feature 5
Supply voltage tolerance	± 10%
Certification (only for DHER)	<b>cURus</b> North American Standard

### 4 NOTES

#### 1 Options

- A** = Solenoid mounted at side of port B (only for single solenoid valves). In standard versions, solenoid is mounted at side of port A.
- WP** = prolonged manual override protected by rubber cap - see section 11.
- SP-WPD/HS-DC** = (only for DHE-DC) manual override with detent, to be ordered separately, see tab. K150
- L1, L2, L3** = device for switching time control, installed in the valve solenoid.  
For spools 4 and 4/8 only device L3 is available.
- F\*** = with proximity switch for monitoring spool position: see tab. E110.
- MV, MO** = auxiliary hand lever positioned vertically (MV) or horizontally (MO). For available configuration and dimensions see table E138.

#### 2 Type of electric/electronic connector DIN 43650, to be ordered separately

- 666** = standard connector IP-65, suitable for direct connection to electric supply source.
- 667** = as 666, but with built-in signal led.

#### 3 Spools

- spools type **0** and **3** are also available as **0/1** and **3/1** with restricted oil passages in central position, from user ports to tank.
- spools type **1, 4, 5** and **58** are also available as **1/1, 4/8, 5/1** and **58/1**. They are properly shaped to reduce water-hammer shocks during the swiching.
- spools type **1, 1/2, 3, 8** are available as **1P, 1/2P, 3P, 8P** to limit valve internal leakages.
- Other types of spools can be supplied on request.

### 5 ELECTRIC FEATURES

External supply nominal voltage ± 10%	Voltage code	Type of connector	Power consumption (2)	Code of spare coil DHE	Code of spare coil DHER		
12 DC	<b>12 DC</b>	666 or 667	30 W	COE-12DC /10	COER-12DC /10		
14 DC	<b>14 DC</b>			COE-14DC /10	COER-14DC /10		
24 DC	<b>24 DC</b>			COE-24DC /10	COER-24DC /10		
28 DC	<b>28 DC</b>			COE-28DC /10	COER-28DC /10		
48 DC	<b>48 DC</b>			COE-48DC /10	COER-48DC /10		
110 DC	<b>110 DC</b>			COE-110DC /10	COER-110DC /10		
125 DC	<b>125 DC</b>			COE-125DC /10	COER-125DC /10		
220 DC	<b>220 DC</b>			COE-220DC /10	COER-220DC /10		
110/50 AC	<b>110/50/60 AC</b>			669	58 VA (3)	COE-110/50/60AC /10 (1)	COER-110/50/60AC /10 (1)
230/50 AC	<b>230/50/60 AC</b>					COE-230/50/60AC /10 (1)	COER-230/50/60AC /10 (1)
115/60 AC	<b>115/60 AC</b>	COE-115/60AC	COER-115/60AC				
230/60 AC	<b>230/60 AC</b>	COE-230/60AC	COER-230/60AC				
110/50 AC - 120/60 AC	<b>110 RC</b>	COE-110RC	COER-110RC				
230/50 AC - 230/60 AC	<b>230 RC</b>	COE-230RC	COER-230RC				

- (1) Coil can be supplied also with 60 Hz of voltage frequency: in this case the performances are reduced by 10 ÷ 15% and the power consumption is 52 VA.  
(2) Average values based on tests performed at nominal hydraulic condition and ambient/coil temperature of 20°C.  
(3) When solenoid is energized, the inrush current is approx 3 times the holding current. Inrush current values correspond to a power consumption of about 160 VA.

### 6 COILS WITH SPECIAL CONNECTORS

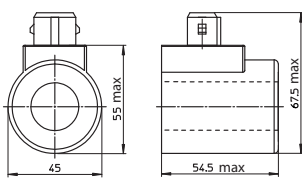
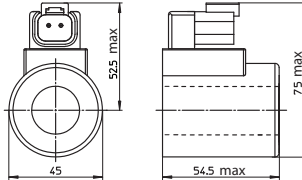
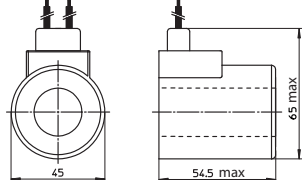
AMP Junior timer connector	Deutsch connector DT-04-2P	Lead Wire connection
 <p><b>Options -XJ</b> Coil type COERJ AMP Junior Timer connector Protection degree IP67</p>	 <p><b>Options -XK</b> Coil type COERK Deutsch connector DT-04-2P male Protection degree IP67</p>	 <p><b>Options -XS</b> Coil type COERS Lead Wire connection Cable length = 180 mm</p>

Note: The above coils are available only for voltage supply **12, 14, 24** and **28 Vdc**. For the characteristics refer to standard coils features - see sect. 5

**7 Q/ΔP DIAGRAMS** based on mineral oil ISO VG 46 at 50°C

Flow direction Spool type	P→A	P→B	A→T	B→T	P→T
	0, 0/1	A	A	C	C
1, 1/1	D	C	C	C	
3, 3/1	D	D	A	A	
4, 4/8, 5, 5/1, 58, 58/1 09, 90, 91, 93, 94	F	F	G	C	E
1/2, 0/2	D	D	D	D	
6, 7	D	D	D	D	
8	A	A	E	E	
2	D	D			
2/2	F	F			

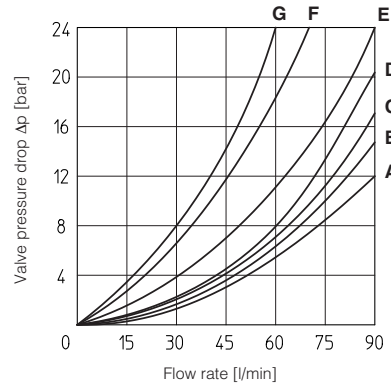

**8 OPERATING LIMITS** based on mineral oil ISO VG 46 at 50°C

The diagrams have been obtained with warm solenoids and power supply at lowest value ( $V_{nom} - 10\%$ ). The curves refer to application with symmetrical flow through the valve (i.e. P→A and B→T). In case of asymmetric flow and if the valves have the devices for controlling the switching times the operating limits must be reduced.

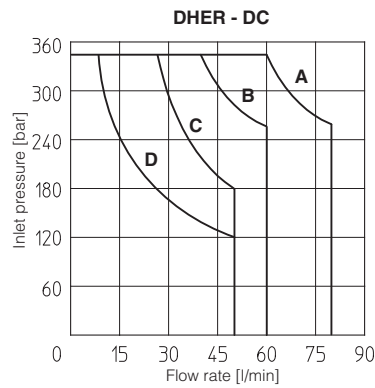
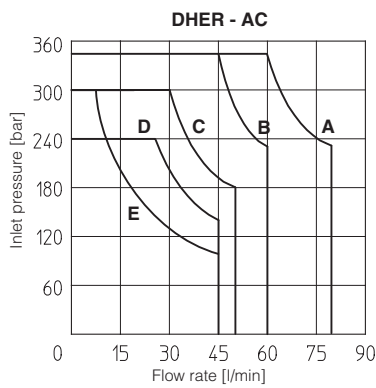

**DHER - AC**

- A = Spools 1, 1/2, 8
- B = Spools 0, 0/1, 0/2, 1/1
- C = Spools 3, 3/1
- D = Spools 4, 4/8, 5, 5/1, 6, 7, 19, 39, 58, 58/1, 09, 90, 91, 93, 94
- E = Spools 2, 2/2

**DHER - DC**

- A = Spools 0, 0/1, 1, 1/2, 3, 8
- B = Spools 0/2, 1/1, 6, 7
- C = Spools 3/1, 4, 4/8, 5, 5/1, 19, 39, 58, 58/1, 09, 90, 91, 93, 94
- D = Spools 2, 2/2

**9 SWITCHING TIMES** (average values in msec)

Valve	Switch-on AC	Switch-on DC	Switch-off
DHE	—	50	20
DHE*/L1	—	60	60
DHE*/L2	—	80	80
DHE*/L3	—	150	150

Test conditions:

- 36 l/min; 150 bar
- nominal voltage
- 2 bar of counter pressure on port T
- mineral oil: ISO VG 46 at 50°C.

The elasticity of the hydraulic circuit and the variations of the hydraulic characteristics and temperature affect the response time.

**10 ELECTRIC CONNECTORS ACCORDING TO DIN 43650** The connectors must be ordered separately

666, 667 (for AC or DC supply)	669 (for AC supply)	CONNECTOR WIRING	
		<b>666, 667</b> 1 = Positive ⊕ 2 = Negative ⊖ ⊕ = Coil ground	<b>669</b> 1,2 = Supply voltage V <sub>AC</sub> 3 = Coil ground
<b>SUPPLY VOLTAGES</b>			
<b>666</b> All voltages	<b>667</b> 24 AC or DC 110 AC or DC 220 AC or DC	<b>669</b> 110/50 AC 110/60 AC 230/50 AC 230/60 AC	

**11 DIMENSIONS [mm]**

**ISO 4401: 2005**

**Mounting surface: 4401-03-02-0-05**

Fastening bolts: 4 socket head screws:

M5x30 class 12.9

Tightening torque = 8 Nm

Seals: 4 OR 108

Ports P,A,B,T: Ø = 7.5 mm (max)

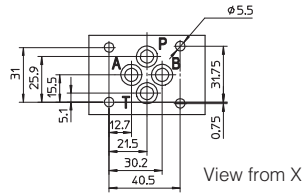

**P** = PRESSURE PORT  
**A, B** = USE PORT  
**T** = TANK PORT

**DHER-06(DC)**

Option /WP

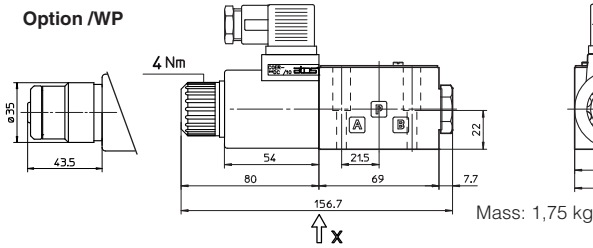

Mass: 1,75 kg

**DHER-07(DC)**

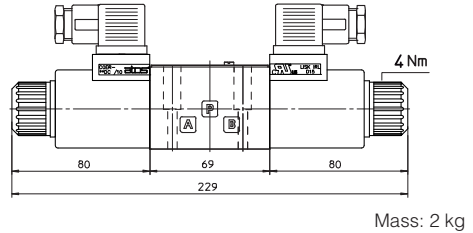

Mass: 2 kg

**DHER-06(AC)**

Option /WP

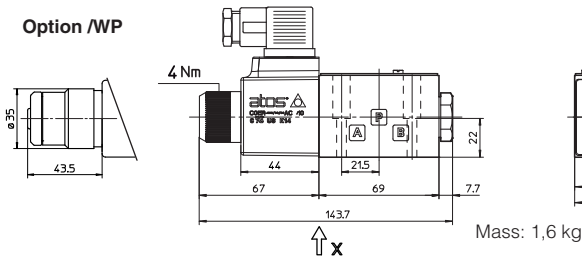

Mass: 1,6 kg

**DHER-07(AC)**

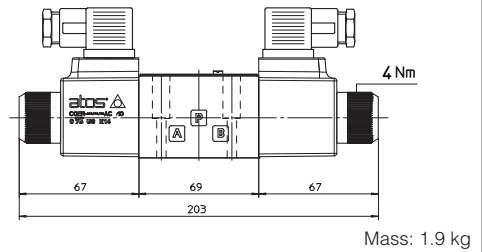

Mass: 1.9 kg

Overall dimensions refer to valves with connectors type 666

**12 MOUNTING SUBPLATES**

Model	Ports location	GAS Ports A-B-P-T	Ø Counterbore [mm] A-B-P-T	Mass [kg]
BA-202	Ports A, B, P, T underneath;	3/8"	-	1,2
BA-204	Ports P, T underneath; ports A, B on lateral side	3/8"	25,5	1,8
BA-302	Ports A, B, P, T underneath	1/2"	30	1,8

The subplates are supplied with 4 fastening bolts M5x50. Also available are multi-station subplates and modular subplates. For further details see table K280.