

Programming tools for TID valve drivers

Atos CONNECT mobile App, Atos PC software, Bluetooth/USB adapters and cables

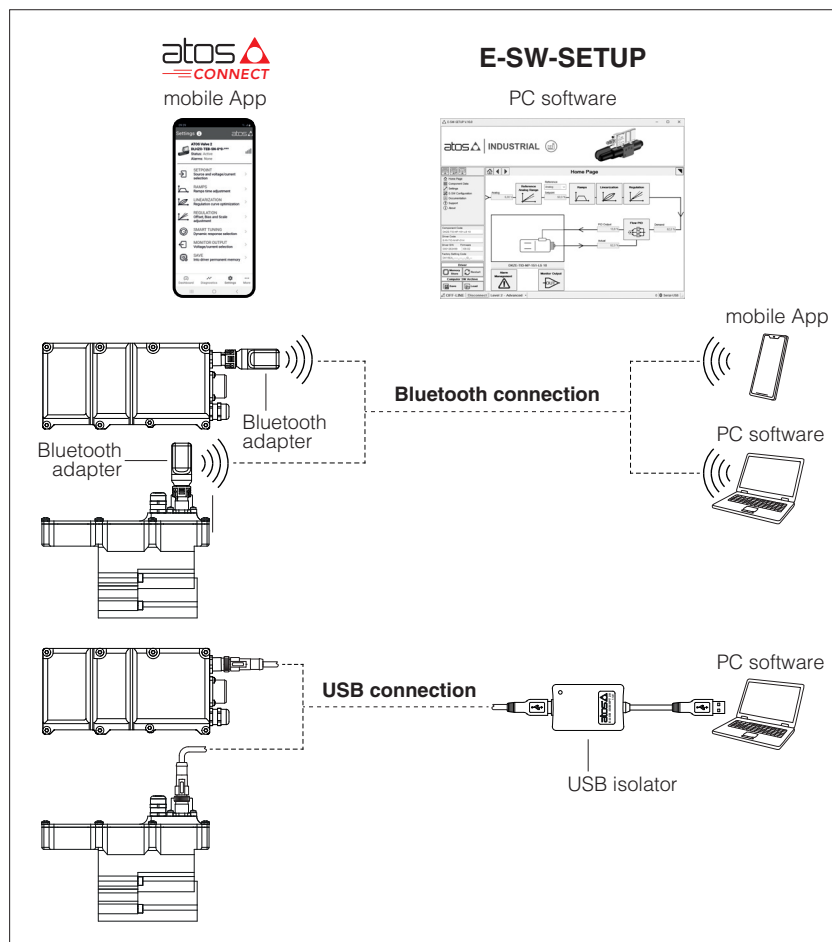

Atos CONNECT is a free iOS / Android mobile App available in the respective App stores, while E-SW-SETUP programming software is developed for Windows and free downloadable at www.atos.com in MyAtos download area.

The intuitive interface allows:

- set up valve's functional parameters
- verify the actual working conditions
- identify and quickly solve fault conditions
- adapt the factory preset parameters to the application requirements
- store the customized setting into the valve drivers
- archive the customized setting into the PC

The interface is organized in pages related to different specific groups of functions and parameters.

The connected devices models are automatically recognized and the parameters groups will be displayed.

General features:

- automatic recognition of connected devices
- numeric parameters settings (scale, bias, ramp, linearization, dither, etc.)
- real-time parameters modification
- diagnostic and monitor signals

Atos CONNECT mobile App:

- supports Bluetooth communication for all Atos devices except valves with p/Q control or axis controls

E-SW-SETUP PC software:

- supports Bluetooth/USB communication for all Atos devices
- internal oscilloscope function
- firmware update

1 PROGRAMMING TOOLS

1.1 Atos CONNECT mobile App

Free downloadable App for smartphones and tablets which allows quick access to valve main functional parameters and basic diagnostic information via Bluetooth, thus avoiding physical cable connection and significantly reducing commissioning time.

Atos CONNECT supports Atos digital valve drivers equipped with E-A-BTH adapter or with built-in Bluetooth.

It does not support valves with p/Q control or axis controls.



Minimum requirements

iOS	iOS 14
Android	Android 9
Interface	Bluetooth Low Energy (BLE), version 4.0

1.2 E-SW-SETUP PC software

Free downloadable software for PC allows to set all valve functional parameters and to access complete diagnostic information of digital valves drivers via Bluetooth/USB service port.

Atos PC software supports all Atos digital valves drivers and it is available in MyAtos area upon web registration at www.atos.com.

Minimum requirements

Personal Computer	Pentium® processor 1GHz or equivalent
Operating System	Windows 7 SP1
Monitor Resolution	1024 x 768
Memory	2 GB RAM + Hard Disk with 1 GB free space
Interface	USB port Bluetooth Low Energy (BLE), version 4.0

2 BLUETOOTH connection - ADAPTER

Bluetooth connection permits the functional parameters programming through mobile App and PC software (1).

2.1 Connection tools

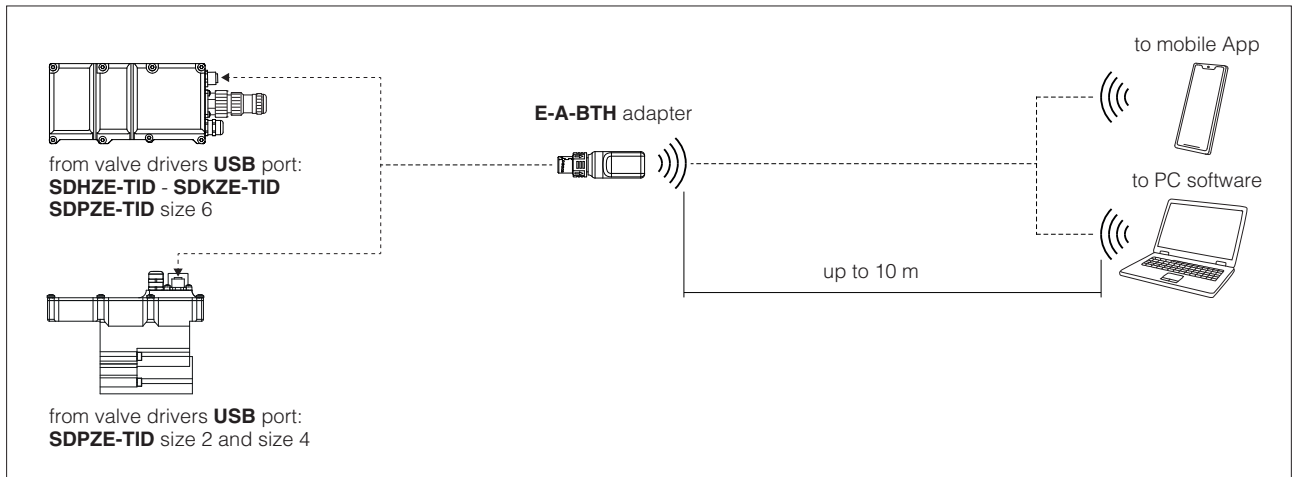

(1) The previous versions of the Bluetooth adapter E-A-SB-USB/BTH and cable E-C-SB-USB/M12 are still compatible

2.2 E-A-BTH - Bluetooth adapter

E-A-BTH adapter adds the Bluetooth® connectivity to Atos valve drivers. E-A-BTH adapter can be left permanently installed on-board, to allow the Bluetooth connection with the valve drivers at any time.

E-A-BTH adapter can be directly supplied with the valve drivers selecting **T** option or purchased separately.

Bluetooth connection to the Atos devices can be protected against unauthorised access by setting a personal password.

The adapter leds visually indicates the status of valve drivers and Bluetooth connection.

For more info, please refer to STARTUP-BLUETOOTH guide.

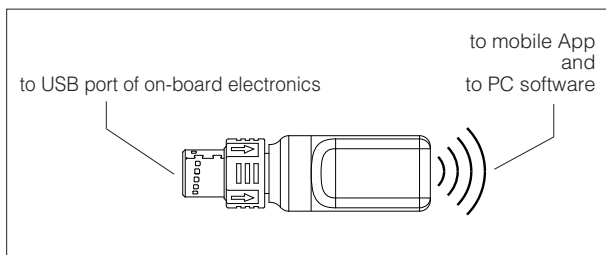

- M12 male connector, coding B, 5pin, push pull type
- Operating temperature: $-40 \div +60$ °C (storage $-40 \div +70$ °C)
- Bluetooth technology: Bluetooth Low Energy (BLE) 5.4
- Max RF transmission power: +6 dBm
- Frequency: 2.402 GHz to 2.480 GHz
- Format: IP66 / IP67 protection degree
- Mass: 14 g
- Two LEDs for an immediate basic diagnostic
- External power supply not required (from Atos digital electronics only)

Overview and dimensions [mm]

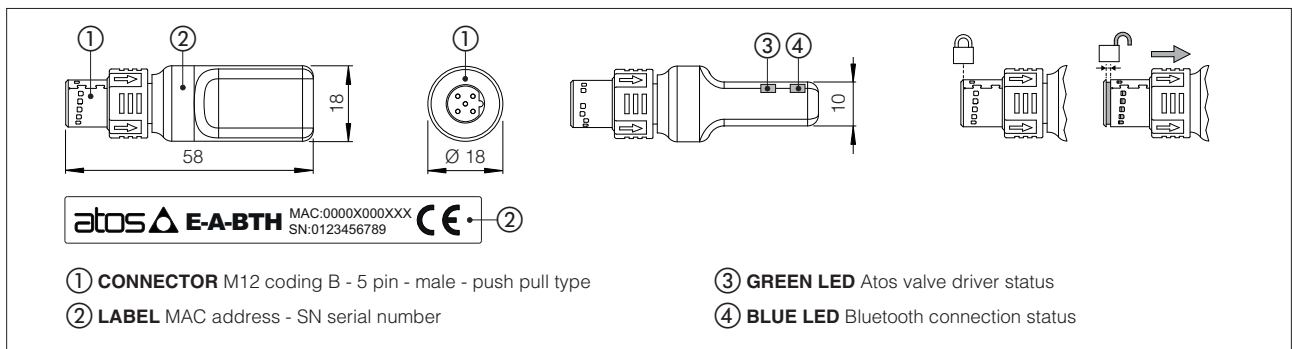

WARNING: Bluetooth adapter is available only for Europe, USA, Canada, China, Japan, India, Korea markets!

Bluetooth adapter is certified according to RED (Europe), FCC (USA), ISED (Canada), SRRC (China), MIC (Japan), BIS (India), KC (Korea) directives

3 USB connection - ISOLATOR AND CABLE

USB connection permits the functional parameters programming through PC software.

3.1 Connection tools

Isolator and cables shown in the image below can be ordered individually or in a single solution purchasing a dedicated kit: **E-KIT-USB**

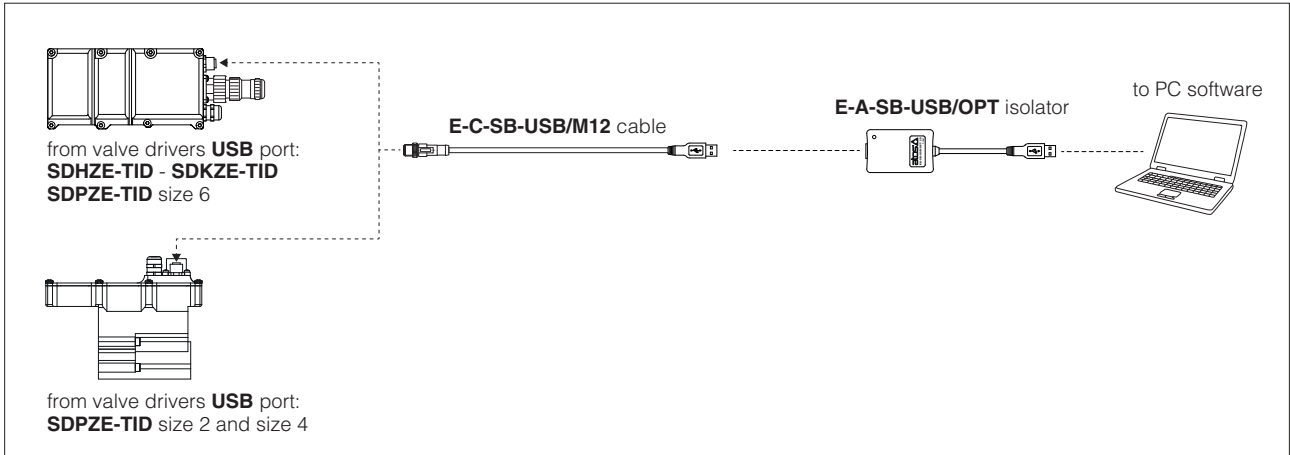

WARNING: the USB port of valve drivers is not isolated and use of USB isolator adapter is highly recommended!

Wrong earthing connections may cause high potential difference between GNDs, generating high currents that could damage valve drivers or the connected PC.

3.2 E-A-SB-USB/OPT isolator adapter

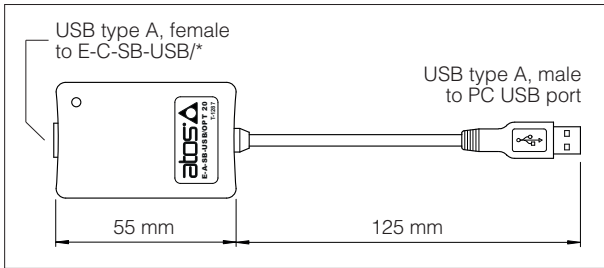

- USB 2.0 Full speed (12 MBps)
- electrical isolation 3 kV
- temperature range, -40°C ÷ +80°C
- external power supply not required
- PC driver not required
- status LED

3.3 E-C-SB-USB/M12 cable - 4 m length

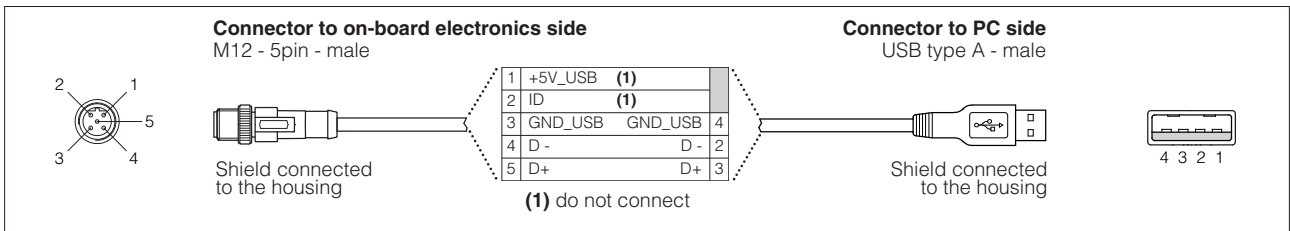

4 FIRMWARE UPDATE - only with E-SW-SETUP PC software via USB cable

It is possible to update the firmware of the following valve drivers, using proper USB communication port. The firmware update is allowed starting from electronics E-RI-TID series10 or higher.

5 PC SOFTWARE AND RECOMMENDED TOOLS SELECTION

5.1 Bluetooth connection tools

Model Code	Series	PC software	Adapter
TID-NP	10 or higher	E-SW-SETUP	E-A-BTH

5.2 USB connection tools

Model Code	Series	PC Software	Adapter	Cable
TID-NP	10 or higher	E-SW-SETUP	E-A-SB-USB/OPT	E-C-SB-USB/M12