

Stainless steel valves for water base fluids

standard or ex-proof solenoid valves with Multicertification ATEX, IECEx, EAC or cULus certification

Available only on request

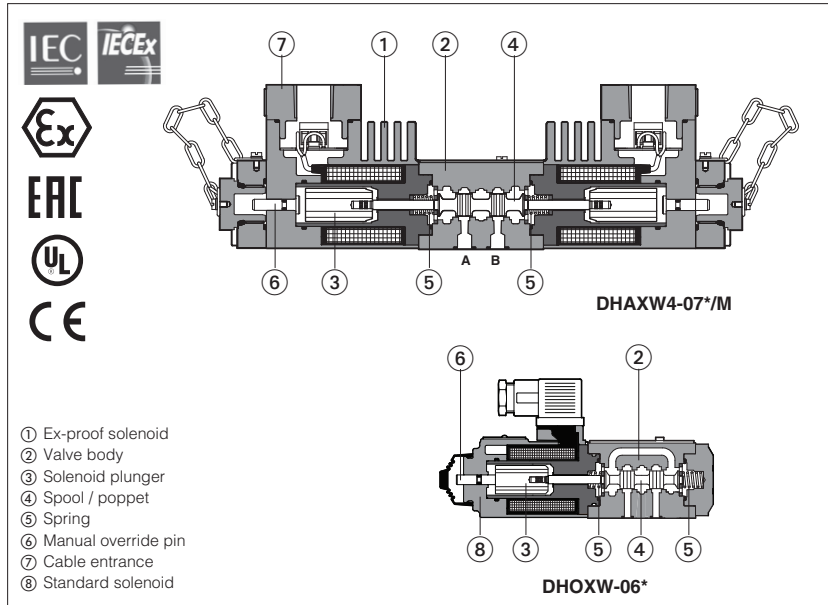

New line of directional solenoid valves with stainless steel internal parts for application with water base fluids.

Features:

- These valves are made by selected inoxidizable materials for internal parts to withstand applications with water base fluids or just pure water. External components are derived from standard valves.
 - Two basic versions are available, poppet type, 3-way leak free (suitable for accumulator systems) or spool type, 4-way on-off valves.
 - The valves are available with standard ⑧ or ex-proof solenoids ①, these last certified according to:
 - Multicertification **ATEX, IECEx, EAC**
 - **cULus** certification
 - ISO standard subplate mounting.
- Options** for ex-proof version:
- Handwheel manual override ⑧ (option /V)
 - Manual reset ⑨ (option /R) for safety applications
 - Horizontal cable entrance.
- Common Applications:**
Steel plants, die casting, foundry.

1 STAINLESS STEEL VALVES: MAIN DATA

Code (1)	Description	ISO size	Voltages		Multicertification			cULus		Max flow l/min	Δp (at max flow) bar	Max pressure bar (3)
			DC	AC 50/60Hz	T class (2)		Input Power	T class (2)	Input Power			
DHOXW	4 way, spool type direct solenoid valves	06 (ISO 4401)	12	-	-	-	32 W (only for 12 and 24 DC)	-	-	60	see diagram at section ⑧	350
DLOHXW	3 way, poppet type, direct solenoid valves	06 (ISO 4401)	24		-	-	40 W (only for 110 and 220 DC)	-	-	12		350
DLOHMXW	3 way, poppet type, direct solenoid valves	06 (ISO 4401)	110		-	-		-	-	25		315
DLOPXW	3 way, poppet type, piloted solenoid valve	no	220		-	-	-	-	220	315		
DHAXW6 DHAXW4	4 way, spool type direct solenoid valves	06 (ISO 4401)	12	12	T6 T4	T4 T3	8 W 25 W	T6, T5 T3	12 W 33 W	60 70		350
DLAHXW6 DLAHXW4	3 way, poppet type, direct solenoid valves	06 (ISO 4401)	24		T6 T4	T4 T3	8 W 25 W	T6, T5 T3	12 W 33 W	10 12		315 350
DLAHMXW6 DLAHMXW4	3 way, poppet type, direct solenoid valves	06 (ISO 4401)	110	110	T6 T4	T4 T3	8W 25 W	T6, T5 T3	12 W 33 W	25 30		250 315
DLAPXW6	3 way, poppet type, piloted solenoid valve	no	220		230	T6	T4	8 W	T6, T5	12 W		220

Notes:

1) XW6 and XW4 versions differ only for the coil power (see Input Power)

2) Solenoid temperature class, see section ③

3) Max pressure on T port = 110 bar

Valves are provided by HNBR seals, which allow min ambient temperature down to -40 °C (max oil viscosity = 380 cSt). The min ambient temperature for valves with PE option (FPM seals) is -20°C.

Max ambient temperature without solenoids is 70°C

2 MATERIALS SPECIFICATION

Valve type	solenoid housing ①	valve body ②	internal parts ③ + ④	spring ⑤	seals	
					std	/PE
DHAXW DHOXW	Cast iron	AISI 316L	AISI 316L, 420B, 440C, 430F	AISI 302	HNBR (buna)	FPM (viton)
DLOHXW DLOHMXW DLAHXW DLAHMXW	Cast iron	AISI 316L	AISI 316L, 420B, 440C, 430F	AISI 302	HNBR (buna)	FPM (viton)
DLOPXW DLAPXW	Cast iron	AISI 630	AISI 316L, 420B, 440C, 430F	AISI 302	HNBR (buna)	FPM (viton)

3 EX-PROOF SOLENOIDS: MAIN DATA

VALVE TYPE	DHAXW6 DLAHXW6	DLAHMXW6 DLAHPXW6	DHAXW4 DLAHXW4	DLAHMXW4										
Solenoid code	OAXW/WP		OAKXW/WP											
Multicertification	OAXWUL/WP		OAKXWUL/WP											
cULus	OAXWUL/WP		OAKXWUL/WP											
Voltage code	<table border="0"> <tr> <td>Vdc</td> <td>±10%</td> <td colspan="3">12DC, 24DC, 48DC (1), 110DC, 125DC (1), 220DC</td> </tr> <tr> <td>VAC 50/60 Hz</td> <td>±10%</td> <td colspan="3">12AC, 24AC, 110-120AC, 230-240AC</td> </tr> </table>				Vdc	±10%	12DC, 24DC, 48DC (1), 110DC, 125DC (1), 220DC			VAC 50/60 Hz	±10%	12AC, 24AC, 110-120AC, 230-240AC		
Vdc	±10%	12DC, 24DC, 48DC (1), 110DC, 125DC (1), 220DC												
VAC 50/60 Hz	±10%	12AC, 24AC, 110-120AC, 230-240AC												
Power consumption	8W		25W											
Multicertification	12W		33W											
cULus	12W		33W											
Coil insulation	Class H													
Protection degree	IP 66/67 According to IEC 144 when correctly coupled with the relevant cable gland, see table K600													
Duty factor	100%													
Mechanical construction	Flame proof housing classified Ex d, according to EN 60079-0: 2006, EN 6079-1: 2007													
Multicertification	Flame proof housing classified according to UL 1203 and UL429, CSA 22.2 n°30-1986 and CSA 22.2 n°139-13													
cULus	Flame proof housing classified according to UL 1203 and UL429, CSA 22.2 n°30-1986 and CSA 22.2 n°139-13													
Cable entrance and electrical wiring	Internal terminal board for cable connection threaded connection for cable entrance vertical (standard) or Horizontal (option /O)													
Method of protection	Ex d													
Multicertification	Temperature class	T6 (≤ 85°C)	T4 (≤ 135°C)	T4 (≤ 135°C)										
	Ambient temperature	-40 ÷ +45 °C	-40 ÷ +70 °C	-40 ÷ +40 °C										
				T3 (≤ 200°C)										
				-40 ÷ +70 °C										
cULus	Temperature class	T6 (≤ 85°C)	T5 (≤ 100°C)	T3 (≤ 200°C)										
	Ambient temperature	-40 ÷ +55 °C	-40 ÷ +70 °C	-40 ÷ +70 °C										

Notes: (1) 48DC and 125DC only for Multicertification

For alternating current supply a rectifier bridge is integrated in the solenoid

4 MAIN CHARACTERISTICS, SEALS AND HYDRAULIC FLUIDS - for other fluids not included in below table, consult our technical office





Assembly position / location	Any position for all valves		
Subplate surface finishing	Roughness index Ra 0,4 - flatness ratio 0,01/100 (ISO 1101)		
Seals, recommended fluid temperature	HNBR seals (standard) = -40°C ÷ +60°C, with HFC hydraulic fluids = -40°C ÷ +50°C FKM seals (/PE option) = -20°C ÷ +80°C		
Recommended viscosity	15÷100 mm ² /s - max allowed range 2.8 ÷ 500 mm ² /s		
Fluid contamination class	ISO 4406 class 21/19/16 NAS 1638 class 10, in line filters of 25 µm (β10 ≥75 recommended)		
Hydraulic fluid	Suitable seals type	Classification	Ref. Standard
Mineral oils	HNBR, FKM	HL, HLP, HLPD, HVLP, HVLPD	DIN 51524
Flame resistant without water	FKM	HFDU, HFDR	ISO 12922
Flame resistant with water	HNBR	HFC	

5 cULus CERTIFICATION

cULus marking

Class I	= Equipment for famable gas and vapours
Division 1	= Possibility of explosive atmosphere during normal functioning
Groups C&D	= Atmosphere containing flammable gas
Groups IIA&IIB	= Gas group
T6/T5	= Temperature class of solenoid surface referred to +55°C / +70°C ambient temperature

EXAMPLE OF NAMEPLATE MARKING

MODEL CODE	0A/EC-24DC		
SERIAL N°	XXXXXXXXXX		
Class I, Groups C & D		T. class T6/T5	
Class I, Groups II A & II B		T. class T6/T5	
Max ambient temp. 55/70 °C		131/158 °F	
Electrical rating : 24 V DC 12W			
CAUTION: To reduce the risk of ignition of hazardous atmospheres, disconnect from circuit before opening enclosure. Keep tightly closed when in operation. ATTENTION: Pour réduire le risque d'allumage des atmosphères dangereuses, déconnecter le circuit avant d'ouvrir le boîtier. Garder le bien fermé lorsqu'il est en fonctionnement.			
Marking according to UL Directive			
Notified body and certificate number			

6 MULTICERTIFICATION ATEX, IECEX, EAC

In the following are resumed the valves marking according to multicertifications for Group II

GROUP II, ATEX, marking

II 2 G	= Solenoid for surface plants with gas and vapors environment, category 2, suitable for zone 1 and zone 2
Ex d	= Explosion-proof equipment
II C	= Equipment of group IIC suitable for substances (gas) of group IIC
T6/T4	= Solenoid temperature class (maximum surface temperature)
Gb	= Equipment protection level, high level protection for explosive Gas atmospheres
CE	= Mark of conformity to the applicable European directives
II 2 D	= Solenoid for surface plants with dust environment, category 2, suitable for zone 21 and zone 22
Ex d	= Explosion-proof equipment
III C	= Suitable for conductive dust (applicable also IIIB and/or IIIA)
IP66/67	= Protection degree
T85/T135	= Maximum surface temperature (Dust)
Db	= Equipment protection level, high level protection for explosive Dust atmospheres
	= Mark of conformity to the 94/9/CE directive and to the technical norms

GROUP II, IECEX marking

Ex d	= Explosion-proof equipment
IIC	= Equipment of group IIC suitable for substances (gas) of group IIC
T6/T4	= Solenoid temperature classes (Gas)
Gb	= Equipment protection level, high level protection for explosive Gas atmospheres
Ex tb	= Equipment protection by enclosure "tb"
IIIC	= Suitable for conductive dust (applicable also IIIB and/or IIIA)
T85°C/T135°C	= Maximum surface temperature (Dust)
Db	= Equipment protection level, high level protection for explosive Dust atmospheres
IP66/67	= Protection degree

6.1 EAC marking

EAC certification acknowledges the whole ATEX Directive 94/9/EC. This certification is available only for gas environment (not for dust).

II 2 G	= Solenoid for surface plants with gas and vapors environment, category 2, suitable for zone 1 and zone 2
Ex d	= Explosion-proof equipment
II C	= Equipment of group IIC suitable for substances (gas) of group IIC
T6/T4	= Solenoid temperature class (maximum surface temperature)

	= Mark of conformity to the 94/9/CE directive and to the technical norms
---	--

EXAMPLE OF NAMEPLATE MARKING

Atex notified body and certificate number	MODEL N° <input type="text"/>	
	SERIAL N° <input type="text"/>	atos spa - Via alla Piana, 57 2018 Sesto Calende (Val Italy)
Marking according to ATEX Directive	CE 0722 CESI 02 ATEX 014X	
IECEX notified body and certificate number	Ex II 2G Ex d IIC T6/T4 Gb	
	Ex II 2D Ex tb IIIC T85°C / T135°C Db	
Marking according to IECEX Directive	IECEX CES 10.0010X	
	Ex d IIC T6/T4 Gb	
	Ex tb IIIC T85°C / T135°C Db	
Russian notified body and certificate number	TP TC N° TC RU C-IT. Г Б08.В. 01784 012/2011	Серия RU N 0408158
Marking according to ATEX Directive	ERC Ex II 2G Exd IIC T6/T4	
	Supply <input type="text"/> W <input type="text"/> V <input type="text"/> Hz	
	Tamb. - <input type="text"/> ÷ + 45 °C / +70 °C	IP66/67
	For the correct selection of connecting cable temperatures see safety instructions	
	AT-907/BT	

7 SPOOL TYPE DIRECTIONAL SOLENOID VALVES: MODEL CODE

DH	A	XW	4	*	-	0	63	1/2	-	M	V	24DC	**	/*
-----------	----------	-----------	----------	----------	----------	----------	-----------	------------	----------	----------	----------	-------------	-----------	-----------

Spool type - direct

A = ex-proof solenoids
O = standard solenoids

Stainless steel execution for internal parts

Temperature class, see sect. 1 (only for DHA)
4 = T4 **6** = T6

Certification type
- omit for Multicertification
/UL = cULus with 1 m cable length, factory wired

Size: **0** = 06

Valve configuration, see section 7.1
61, 63, 71, 75
(configurations 63 and 75 are available only with spool type 1/2)

Seals material, see section 4:
- = NBR
PE = FKM

Series number

Voltage code - see section 1

Options:
A = solenoid at side of port B
Options (only for DHA):
V = with handweel manual override
O = horizontal cable entrance

Solenoid threaded connection (only for DHA):
M = M20x1,5 UNI-4535 (6H/6g)
NPT = 1/2" NPT ANSI/ASME B46.1 (tapered) only for **/UL**

Spool type, see section 7.1

7.1 Hydraulic configuration

<p>Configuration for DHA</p> <p>-061*</p> <p>061*/A</p> <p>-071*</p>	<p>Spools for DHA</p> <p>1 0 2</p>	<p>Configuration for DHA</p> <p>-063*</p> <p>-063*/A</p> <p>-075</p>	<p>Spools for DHA</p> <p>1 0 2</p>
--	--	--	--

8 POPPET TYPE LEAK FREE DIRECTIONAL SOLENOID VALVES: MODEL CODE

DLOH	XW	6	*	-	3	A	-	M	V	24DC	**	/*
-------------	-----------	----------	----------	----------	----------	----------	----------	----------	----------	-------------	-----------	-----------

Standard solenoid
DLOH = direct (12 l/min)
DLOHM = direct (25 l/min)
DLOP = electro-hydraulically piloted
Ex-proof solenoid
DLAH = direct (10 l/min)
DLAHM = direct (25 l/min)
DLAP = electro-hydraulically piloted

Stainless steel execution for internal parts

Temperature class, see sect. 1 (only for ex-proof solenoids)
4 = T4 (for DLAH and DLAHM)
6 = T6 (for all ex-proof models)

Certification type
- omit for Multicertification
/UL = cULus with 1 m cable length, factory wired

3 = three way

Seals material, see section 4:
- = NBR
PE = FKM

Series number

Voltage code - see section 1

Options (only for ex-proof solenoids):
R = with solenoid manual reset
V = with handweel manual override
O = Horizontal cable entrance
Only for DLAPXW
D = internal drain
E = external pilot pressure

Solenoid threaded connection (only for ex-proof solenoids):
M = M20x1,5 UNI-4535 (6H/6g)
NPT = 1/2" NPT ANSI/ASME B46.1 (tapered) only for **/UL**

Valve configuration, see section 8.1
A = A to T in rest position **C** = P to A in rest position

8.1 Hydraulic configuration

<p>DLAHXW*-3A/M/V</p>	<p>DLAHXW*-3C/M</p>	<p>DLAHMXW*-3A/M-AO/R</p>	<p>DLAHMXW*-3C/M-AO</p>
<p>DLAPXW6-3A/M</p>	<p>DLAPXW6-3C/M</p>		

9 Q/Δp DIAGRAMS (based on mineral oil ISO VG 46 at 50°C)

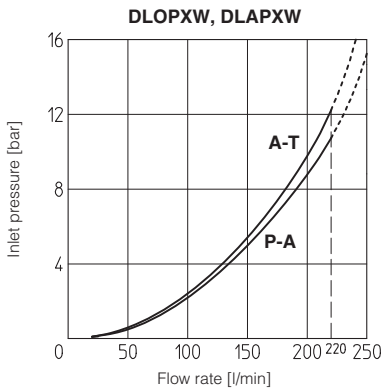
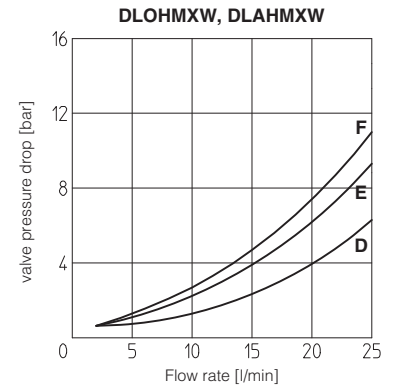
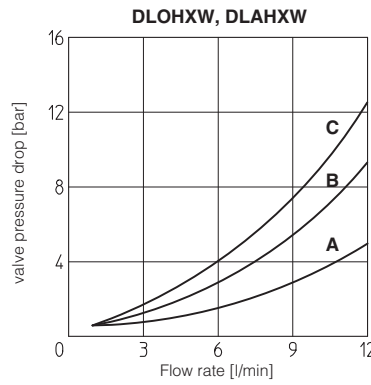
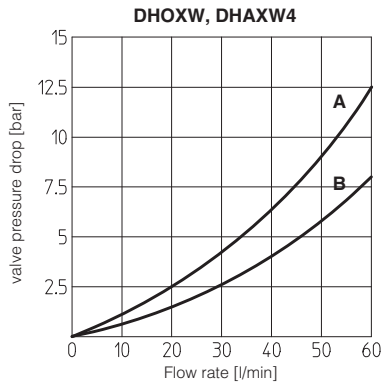

DHOxW, DHAxW

Spool type	Flow direction				
	P → A	P → B	A → T	B → T	P → T
0	B	B	B	B	A
1, 1/2	A	A	A	A	
3	A	A	B	B	
6	A	A	B	A	
7	A	A	A	B	

Valve type	Flow direction	
	P → A (P → B)	A → T (B → T)
DLOHXW-3A	C	B
DLOHXW-3C	B	A
DLOHMxW-3A	F	E
DLOHMxW-3C	E	D

10 OPERATING LIMITS OF ON/OFF DIRECTIONAL CONTROLS (based on mineral oil ISO VG 46 at 50°C)

The diagram have been obtained with warm solenoids and power supply at lowest value ($V_{nom} - 10\%$). For DHAXW valves the curves refer to application with symmetrical flow through the valve (i.e. P → A and B → T). In case of asymmetric flow the operating limits must be reduced.

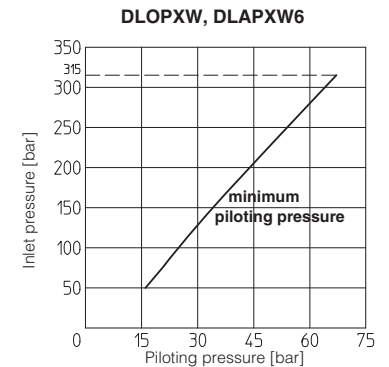
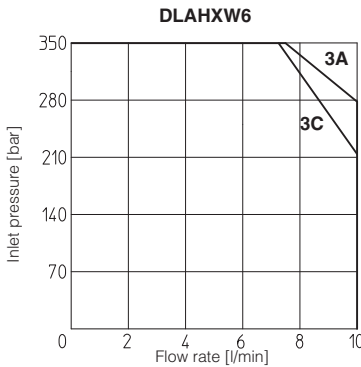
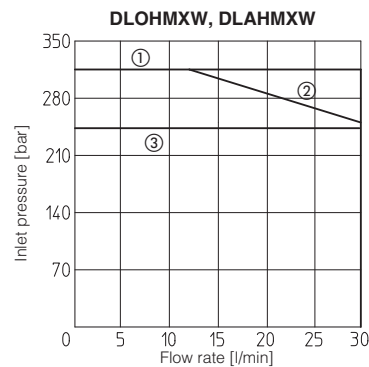
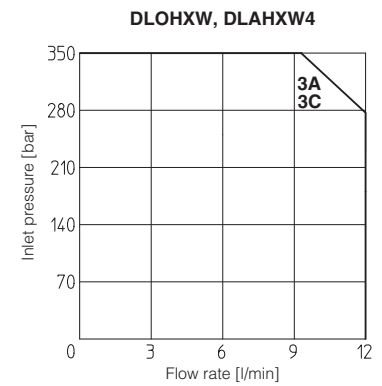
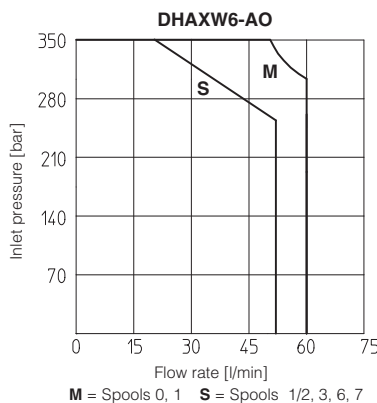
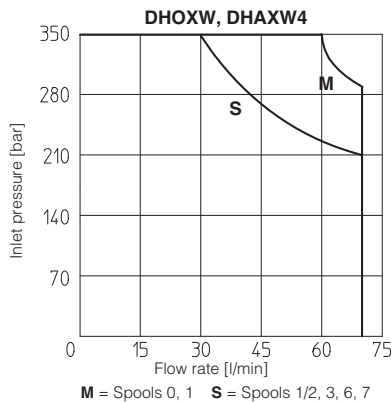

- ① DLOHMxW-3A and DLOKxW4-3A-AO
- ② DLOHMxW-3C and DLOKxW4-3C-AO
- ③ DLOHMxW6-3A(3C)-AO

10.1 Internal leakages

internal leakage of DLOHXW, DLOHMxW, DLOPXW: less than 5 drops/min (0,36 cm³/min) at max pressure.

10.2 Piloting pressure (DLOPXW)

- max piloting pressure = 315 bar
- min piloting pressure = see diagram

11 CABLE GLANDS AND WIRING

11.1 Cable glands - only for Multicertification

Cable glands with threaded connections M20x1,5 for standard or armoured cables have to be ordered separately, see tech. table **K600**

11.2 Ex proof solenoid wiring

Multicertification

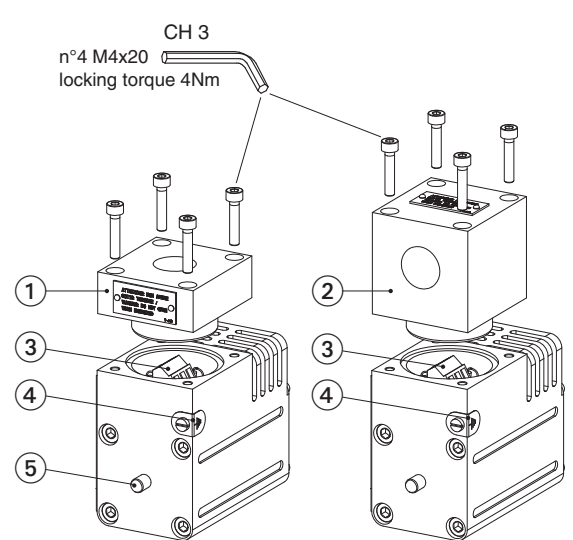

Standard version **Option /O**

- ① cover with threaded connection for vertical cable gland fitting
- ② cover with threaded connection for horizontal cable gland fitting
- ③ terminal board for cables wiring
- ④ screw terminal for additional equipotential grounding
- ⑤ standard manual override

○	○	○
○	○	○
○	○	○

1 = Coil PCB 3 poles terminal board
2 = GND suitable for wires cross sections
3 = Coil up to 2,5 mm² (max AWG14)

Power supply: section of coil connection wires = 2,5 mm²
Grounding: section of internal ground wire = 2,5 mm²
section of external ground wire = 4 mm²

Wiring specifications
Power supply: section of coil connection wires = 2,5 mm²
Grounding: section of internal ground wire = 2,5 mm²

The additional equipotential grounding can be also performed by the user on the external facility provided on the solenoid case.
Section of external ground wire = 4 mm²

cULus certification

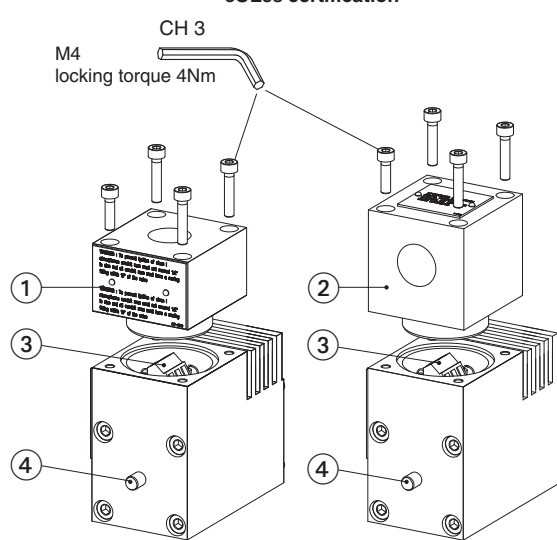

Standard version **Option /O**

- ① cover with threaded connection for vertical cable gland fitting
- ② cover with threaded connection for horizontal cable gland fitting
- ③ terminal board for cables wiring
- ④ standard manual override

○	○	○
○	○	○
○	○	○

1 = Coil + PCB 3 poles terminal board
2 = GND suitable for wires cross sections
3 = Coil - up to 2,5 mm² (max AWG14)

(2) = alternative GND screw terminal
connected to solenoid housing

Cable Specification:
Power supply and transducer cables have to comply with following characteristics

- Suitable for use in Class I Division 1, Gas Groups C
- Armored Marine Shipboard Cable which meets UL 1309
- Tinned Stranded Copper Conductors
- Bronze braided armor
- Overall impervious sheath over the armor

Any Listed (UBVZ/ UBVZ7) Marine Shipboard Cable rated 300 V min, 15A min. 3C 2,5 mm² (14 AWG) having a suitable service temperature range of at least -25°C to +110°C ("BT" Models require a temperature range from -40°C to +110°C)

For Class I wiring the 3C 1,5 mm² AWG 16 cable size is admitted only if a fuse lower than 10 A is connected to the load side of the solenoid wiring.

Note: a Loctite sealant type 545, should be used on the cable gland entry threads

11.3 Cable temperature

The cable must be suitable for the working temperature as specified in the "safety instructions" delivered with the first supply of the products.

For Multicertification

Max ambient temperature [°C]	Temperature class	Surface temperature [°C]	Cable temperature
45 °C	T6	<85 °C	not prescribed
70 °C	T4	<135 °C	90 °C

For cULus

Max ambient temperature [°C]	Temperature class	Surface temperature [°C]	Cable temperature
55 °C	T6	<85 °C	100 °C
70 °C	T5	<100 °C	100 °C

12 INSTALLATION DIMENSIONS OF DHOXW [mm]

ISO 4401: 2005

Mounting surface: 4401-03-02-0-05

Fastening bolts:

4 socket head screws M5x50 class 12.9

Tightening torque = 8 Nm

Seals: 4 OR 108

Ports P,A,B,T: $\varnothing = 7.5$ mm (max).

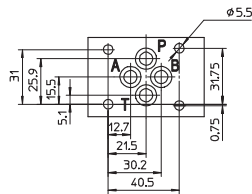

P = PRESSURE PORT

A, B = USE PORT

T = TANK PORT

For the max pressures on ports, see section 4

DHOXW-06

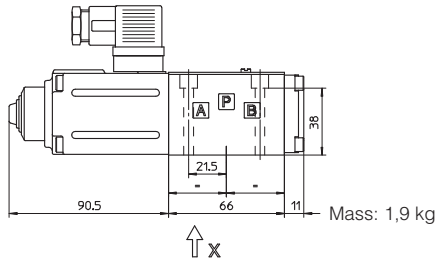

DHOXW-07

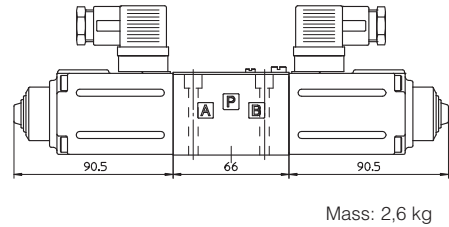

Overall dimensions refer to valves with connectors type 666

13 INSTALLATION DIMENSIONS OF DLOHMXW [mm]

DLOHMXW-3*

ISO 4401: 2005

Mounting surface: 4401-03-02-0-05

Fastening bolts:

4 socket head screws M5x50 class 12.9

Tightening torque = 8 Nm

Seals: 4 OR 108

Ports P, A, B, T:

$\varnothing = 7.5$ mm (max)

DLOHMXW-3C

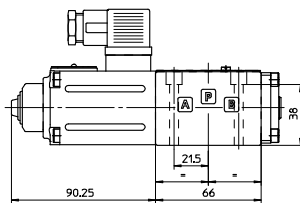

DLOHMXW-3A

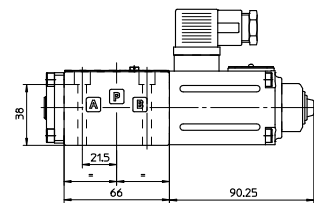

P = PRESSURE PORT

A = USE PORT

B = CLOSED

T = TANK PORT

Overall dimensions refer to valves with connectors type 666

14 INSTALLATION DIMENSIONS OF DLOPXW [mm]

Mounting surface of DLOPXW is not ISO standard

Fastening bolts:

4 socket head screws M10x70-A4-70

Tightening torque = 40 Nm

Seals: 3 OR 3081; 2 OR 108

Ports P,A,T: $\varnothing = 16$ mm (max)

Ports X, Y: $\varnothing = 7$ mm (max)

DLOPXW-3*

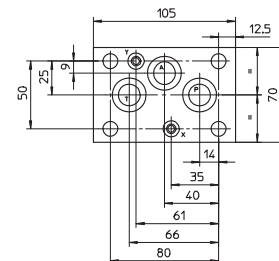
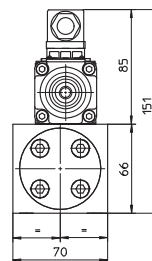
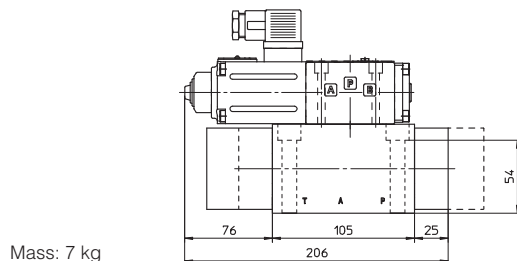

Overall dimensions refer to valves with connectors type 666

15 INSTALLATION DIMENSIONS OF EX-PROOF DHAXW [mm]

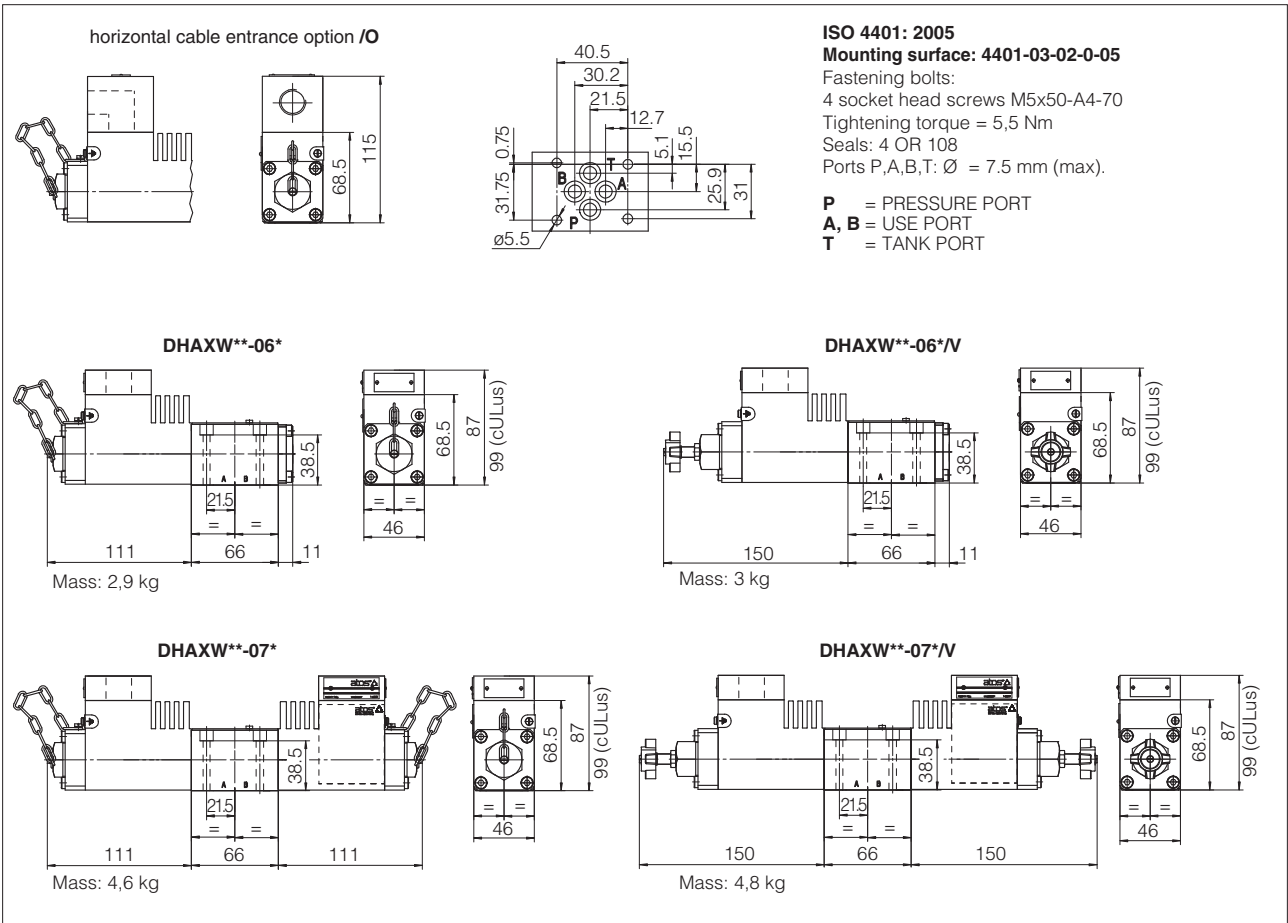

16 INSTALLATION DIMENSIONS OF EX-PROOF DLAHXW AND DLAHMWX [mm]

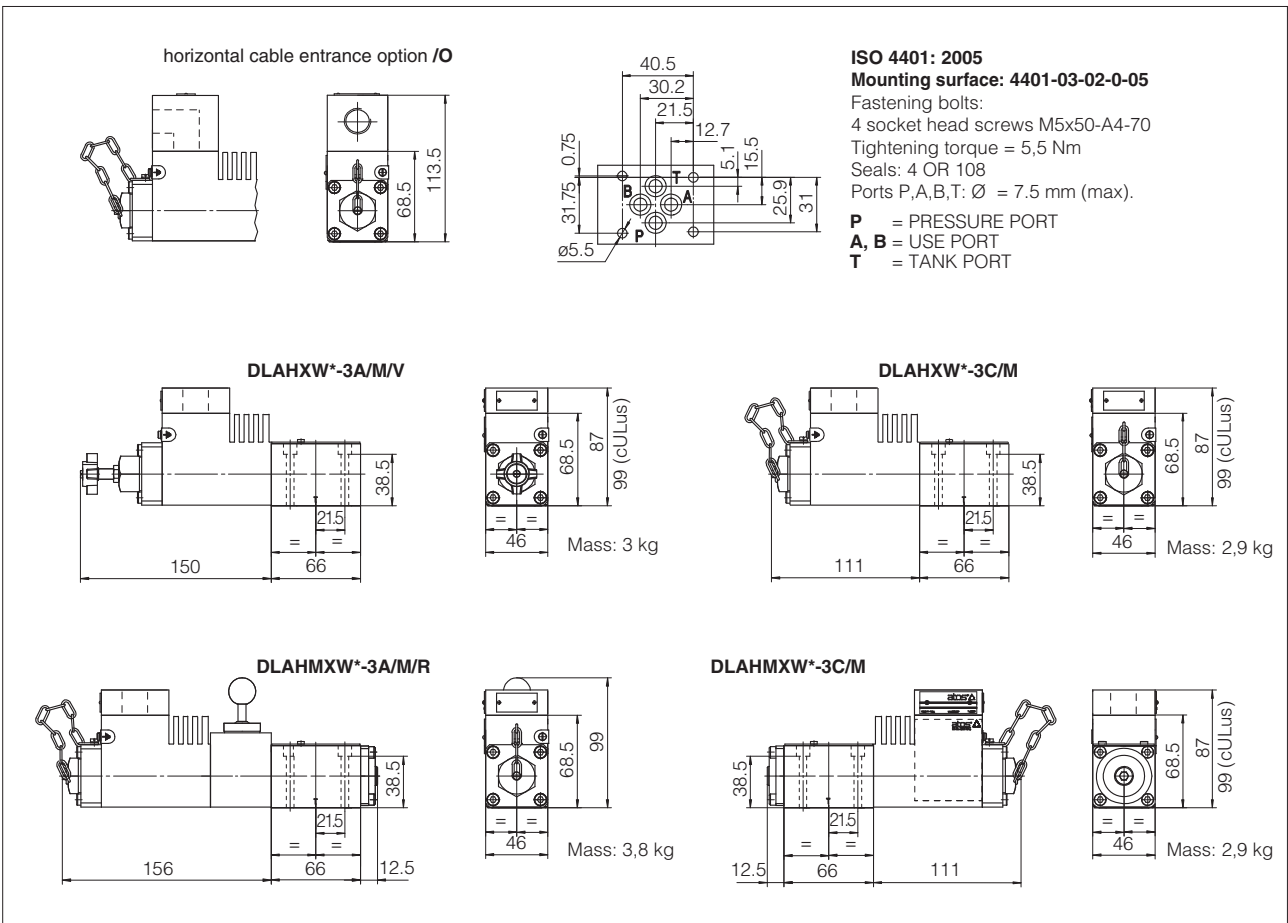

17 INSTALLATION DIMENSIONS OF EX-PROOF DLAPXW [mm]

**Mounting surface DLAPX(S)6 and DLPX(S)
not ISO standard**

Fastening bolts:

4 socket head screws M10x70-A4-70

Tightening torque = 40 Nm

Seals: 3 OR 3081; 2 OR 108

Ports P,A,T: $\varnothing = 16$ mm (max)

Ports X, Y: $\varnothing = 7$ mm (max)

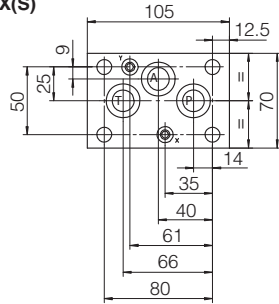

option /O

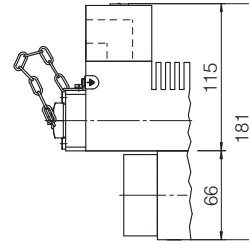

DLAPXW6-3A/M

DLAPXW6-3C/M (dotted line)

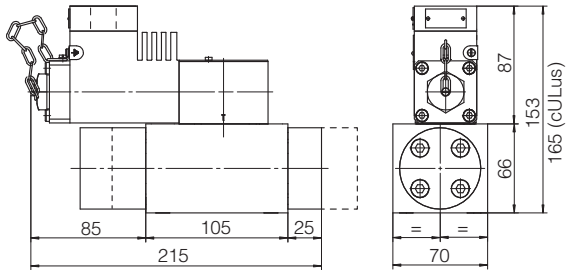

option /V

