

# Proportional pressure reducing valves type **DHRZE**

direct operated, ISO 4401 size 06

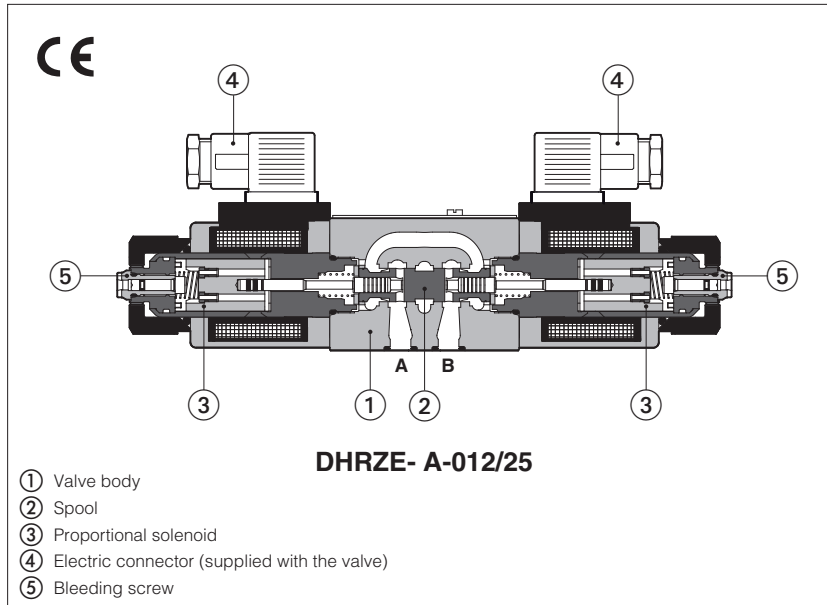

- ① Valve body
- ② Spool
- ③ Proportional solenoid
- ④ Electric connector (supplied with the valve)
- ⑤ Bleeding screw

## DHRZE-A

3 way, direct operated pressure reducing valves, size 06, with proportional solenoids certified according to North American standard **cURus**.

They operate in association with electronic drivers, see section 2, which supply the proportional solenoids with proper current to align the pressure regulation to the reference signal.

### Technical characteristics

They provide the pressure reduction on ports A, or B or A and B, depending on the valve model. The direct execution performs low internal leakages, fast response and low hysteresis.

The solenoid coils are plastic encapsulated with insulation class H and they are available with different nominal resistances depending to the voltage supply (12 V<sub>dc</sub> or 24 V<sub>dc</sub>) and to the electronic driver type, see section 2 and 3.

### Typical applications

Pressure reduction in low flow systems  
Pilot stage of pilot operated valves

Mounting surface: **ISO 4401, size 06**

Max flow: **24 l/min**

Max pressure: **315 bar**

Max regulated pressure: **25 bar**

## 1 MODEL CODE

<b>DHRZE</b>	-	<b>A</b>	-	<b>010</b>	/	<b>25</b>	/	*	/	*	/	**	/	*
Proportional pressure reducing valve size 06												Series number		Seals material, see sect. 5: - = NBR <b>PE</b> = FKM <b>BT</b> = HNBR
<b>A</b> = open loop pressure control														
<b>Configuration:</b>														
<b>010</b> = reduced pressure on port A (port B for option /B)														
<b>012</b> = reduced pressure on port A and B														
<b>Regulated pressure:</b>														
<b>25</b> = reduced pressure range 3÷25 bar														
														<b>Coil options</b> see section 3 and 4: - = standard coil for 24V <sub>dc</sub> Atos drivers <b>6</b> = optional coil for 12V <sub>dc</sub> Atos drivers <b>18</b> = optional coil for 24V <sub>dc</sub> low current drivers
														<b>Hydraulic option</b> <b>B</b> = reduced pressure on port B, solenoid side of port A (only for valve configuration 010)

## HYDRAULIC SYMBOLS

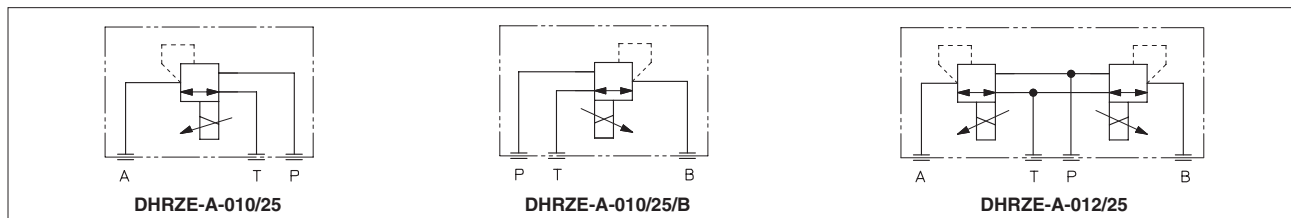

## 2 ELECTRONIC DRIVERS

Drivers model	E-MI-AC		E-MI-AS-IR		E-BM-AC		E-BM-AS-PS		E-BM-AES	E-ME-AC
Type	analog		digital		analog		digital		digital	analog
Voltage supply (V <sub>dc</sub> )	12	24	12	24	12	24	12	24	24	24
Valve coil option	/6	std	/6	std	/6	std	/6	std	std	std
Format	DIN 43650 plug-in to solenoid				DIN 43700 UNDECAL		DIN-rail panel			EUROCARD
Data sheet	G010		G020		G025		G030		GS050	G035

### 3 COIL OPTIONS

#### Coil voltage

**Option /6** optional coil to be used with Atos drivers with power supply 12 Vdc

**Option /18** optional coil to be used with electronic drivers not supplied by Atos

### 4 MAIN CHARACTERISTICS - based on mineral oil ISO VG 46 at 50 °C

Assembly position / location	Any position		
Subplate surface finishing (RZME)	Roughness index Ra 0,4 - flatness ratio 0,01/100 (ISO 1101)		
MTTFd valves according to EN ISO 13849	150 years, see technical table P007		
Ambient temperature	<b>Standard</b> and <b>/PE</b> option = -20°C ÷ +70°C; <b>/BT</b> option = -40°C ÷ +60°C		
Storage temperature	<b>Standard</b> and <b>/PE</b> option = -20°C ÷ +80°C; <b>/BT</b> option = -40°C ÷ +70°C		
Coil code	<b>Standard</b> standard coil to be used with Atos drivers with power supply 24Vdc	<b>option /6</b> optional coil to be used with Atos drivers with power supply 12 Vdc	<b>option /18</b> optional coil to be used with electronic drivers not supplied by Atos, with power supply 24 Vdc and max current limited to 1A
Coil resistance R at 20°C	3 ÷ 3,3 Ω	2 ÷ 2,2 Ω	13 ÷ 13,4 Ω
Max. solenoid current	2,2 A	2,75 A	1,2 A
Max. power	30 Watt		
Protection degree (CEI EN-60529)	IP65		
Duty factor	Continuous rating (ED=100%)		
Certification	<b>cURus</b> North American Standard		

Max regulated pressure (Q=1 l/min) [bar]	25
Min. regulated pressure (Q=1 l/min) <b>(1)</b> [bar]	3
Max. pressure at port P [bar]	315
Max. pressure at port T [bar]	210
Max. flow [l/min]	24
Response time 0-100% step signal <b>(2)</b> (depending on installation) [ms]	≤ 45
Hysteresis [% of the max pressure]	≤ 1,5
Linearity [% of the max pressure]	≤ 3
Repeatability [% of the max pressure]	≤ 2

**Notes:** above performance data refer to valves coupled with Atos electronic drivers, see section 2

**(1)** Min pressure value to be increased of T line pressure

**(2)** Average response time value; the pressure variation in consequence of a modification of the reference input signal to the valve is affected by the stiffness of the hydraulic circuit: greater is the stiffness of the circuit, faster is the dynamic response

### 5 SEALS AND HYDRAULIC FLUID - for other fluids not included in below table, consult our technical office

Seals, recommended fluid temperature	NBR seals (standard) = -20°C ÷ +60°C, with HFC hydraulic fluids = -20°C ÷ +50°C FKM seals (/PE option) = -20°C ÷ +80°C HNBR seals (/BT option) = -40°C ÷ +60°C, with HFC hydraulic fluids = -40°C ÷ +50°C		
Recommended viscosity	20÷100 mm <sup>2</sup> /s - max allowed range 15 ÷ 380 mm <sup>2</sup> /s		
Fluid contamination class	ISO 4406 class 20/18/15 NAS 1638 class 9, in line filters of 10 μm (β10 ≥75 recommended)		
<b>Hydraulic fluid</b>	<b>Suitable seals type</b>	<b>Classification</b>	<b>Ref. Standard</b>
Mineral oils	NBR, FKM, HNBR	HL, HLP, HLPD, HVLP, HVLPD	DIN 51524
Flame resistant without water	FKM	HFDU, HFDR	ISO 12922
Flame resistant with water	NBR, HNBR	HFC	

### 6 GENERAL NOTES

DHRZE proportional valves are CE marked according to the applicable Directives (e.g. Immunity/Emission EMC Directive and Low Voltage Directive). Installation, wirings and start-up procedures must be performed according to the general prescriptions shown in table F003 and in the installation notes supplied with relevant components.

### 7 CONNECTIONS

SOLENOID POWER SUPPLY CONNECTOR	
PIN	Signal description
1	SUPPLY
2	SUPPLY
3	GND

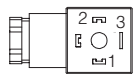

**8 DIAGRAMS** based on mineral oil ISO VG 46 at 50°C

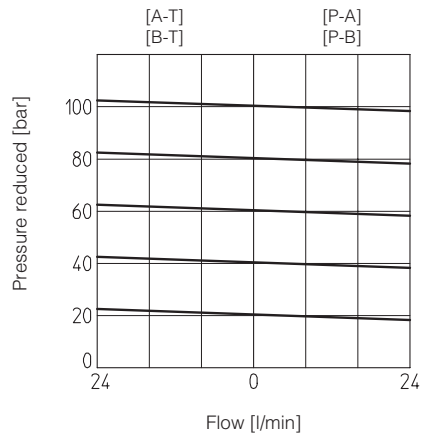
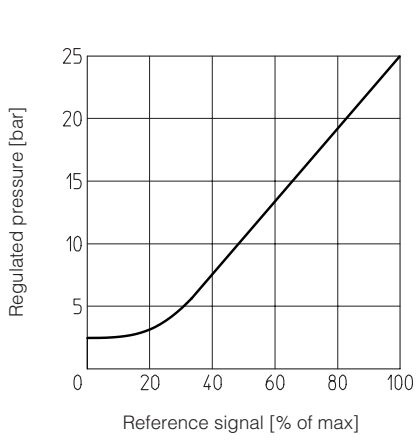

**9 INSTALLATION DIMENSIONS FOR DHRZE [mm]**

ISO 4401: 2005

Mounting surface: 4401-03-02-0-05

Fastening bolts: 4 socket head screws M5x30 class 12.9

Tightening torque = 8 Nm

Seals: 4 OR 108;

Diameter of ports A, B, P, T: Ø 7,5 mm (max)

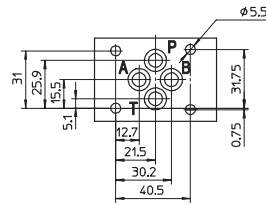

**DHRZE-A-010**

**DHRZE-A-010/B**

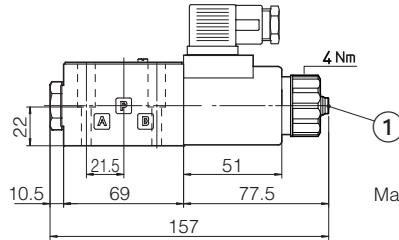
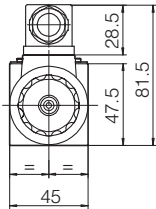

Mass: 1,9 kg

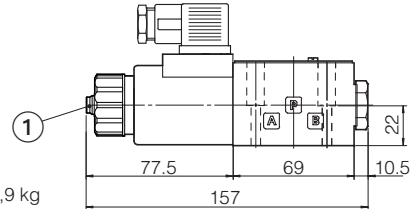

**DHRZE-A-012**

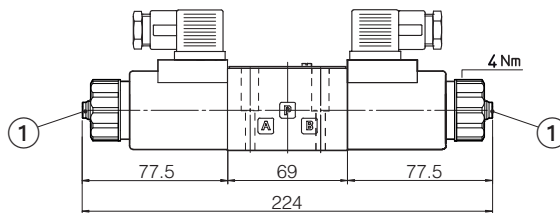

Mass: 2,6 kg

① screw for air bleeding