

Digital electronic REB/RES drivers

integral-to-valve format, for proportional valves with remote pressure transducer

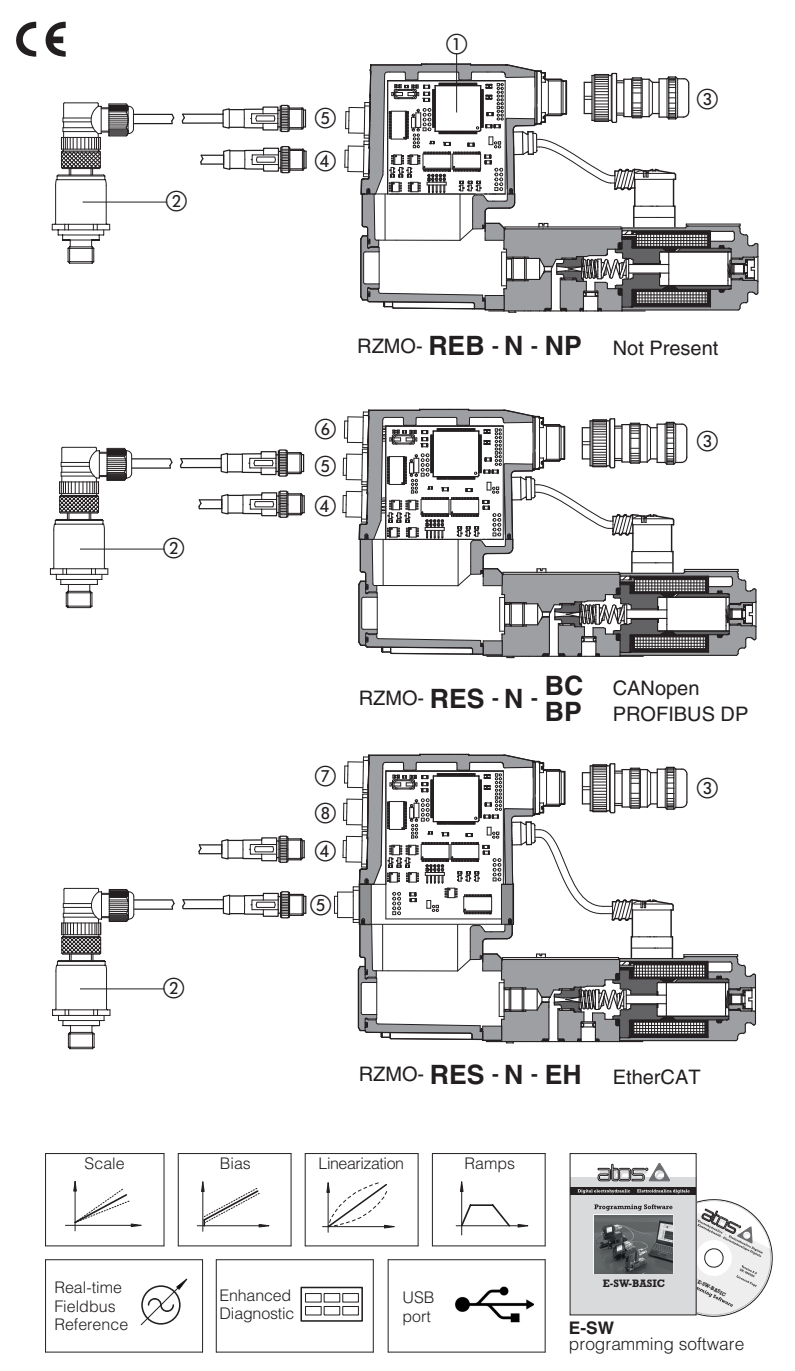

RZMO-REB-N-NP Not Present

RZMO-RES-N-BC/BP CANopen
PROFIBUS DP

RZMO-RES-N-EH EtherCAT

Scale, Bias, Linearization, Ramps, Real-time Fieldbus Reference, Enhanced Diagnostic, USB port, E-SW programming software

Connector ③ and cable ④ not included, to be ordered separately

REB, RES

Digital drivers ① supply and control, in closed loop, the regulated pressure of direct and pilot operated proportional valves according to the electronic reference input signal. REB/RES operate direct and pilot operated relief/reducing control valves with remote pressure transducer ②.

REB basic execution is equipped with USB port for programming.

RES full execution is equipped with fieldbus communication in addition to USB port for programming.

Atos PC software allows to customize the driver configuration to the specific application requirements.

Electrical Features:

- Functional parameters are factory preset for best performances
- 7 pin main connector ③ for power supply, analog input reference and monitor signals
- 5 pin USB connector ④ always present
- 5 pin remote pressure transducer connector ⑤ always present
- 5 pin CANopen or PROFIBUS DP communication connector ⑥ - only for RES
- 4 pin EtherCAT communication connectors ⑦ and ⑧ (input - output) - only for RES
- /Q option 7 pin main connector for enable signal
- /Z option 12 pin main connector for additional double power supply, enable and fault signals
- /C option for cable break detection with current pressure transducer feedback (see 6.6)
- Electrical protection against reverse polarity of power supply
- Operating temperature range: $-40^{\circ} \div +60^{\circ}$
- IP66 / IP67 protection degree
- Rugged construction
- CE mark according to EMC directive

Software Features:

- Intuitive graphic interface
- Setting of valve's functional parameters: bias, scale, ramps, dither, PID gains
- 4 factory pre-set PIDs setting to match different hydraulic conditions
- Linearization function for hydraulic regulation
- Complete diagnostics of driver status
- Internal oscilloscope function
- In field firmware update through USB port

Fieldbus Features - only for RES:

- Valve direct communication with machine control unit for digital reference, diagnostics and settings
- Fieldbus execution allow to operate the valves via fieldbus or via analog signals available on the main connector

1 VALVES RANGE

Valves model	Relief			Reducing			Compensator
	RZMO	AGMZO	LIMZO	RZGO	AGRCZO	LIRZO	LICZO
Data sheet	FS010 FS067	FS040	FS305	FS020 FS075	FS055	FS305	FS305
Driver model	REB / RES						

2 MAIN CHARACTERISTICS

Power supply (see 4.1, 4.4)	Nominal : +24 Vdc Rectified and filtered : $V_{RMS} = 20 \div 32 V_{MAX}$ (ripple max 10 % V_{PP})			
Max power consumption	50 W			
Reference input (see 4.2)	Voltage: maximum range $\pm 10 V_{dc}$ Input impedance: $R_i > 50 k\Omega$ Current: maximum range $\pm 20 mA$ Input impedance: $R_i = 500 \Omega$			
Monitor output (see 4.3)	Voltage: maximum range $0 \div 10 V_{dc}$ @ max 5 mA Current: maximum range $0 \div 20 mA$ @ max 500Ω load resistance			
Enable input (see 4.5)	Range : $0 \div 9 V_{dc}$ (OFF state), $15 \div 24 V_{dc}$ (ON state), $9 \div 15 V_{dc}$ (not accepted); Input impedance: $R_i > 87 k\Omega$			
Fault output (see 4.6)	Output range : $0 \div 24 V_{dc}$ (ON state $\equiv VL+$ [logic power supply] ; OFF state $\equiv 0 V$) @ max 50 mA			
Remote pressure transducer	Power supply: +24Vdc @ max 100 mA Pressure input: voltage, maximum range $\pm 10 V_{dc}$ Input impedance, $R_i > 50 \Omega$ current, maximum range $\pm 20 mA$ Input impedance, $R_i = 500 \Omega$			
Alarms	Solenoid not connected/short circuit, cable break with current reference signal, cable break with current pressure transducer feedback, over/under temperature, power supplies level, pressure transducer failure			
Format	Sealed box on the valve; IP66 / IP67 protection degree with mating connectors			
Tropicalization	Tropical coating on electronics PCB			
Operating temperature	$-40 \div +60 ^\circ C$ (storage $-40 \div +70 ^\circ C$)			
Mass	Approx. 440 g (approx. 570 g for EH execution)			
Additional characteristics	Short circuit protection of solenoid current supply; current control by P.I.D. with rapid solenoid switching; protection against reverse polarity of power supply			
Electromagnetic compatibility (EMC)	According to Directive 2014/30/UE (Immunity: EN 61000-6-2; Emission: EN 61000-6-3)			
Communication interface	USB Atos ASCII coding	CANopen - only for RES EN50325-4 + DS408	PROFIBUS DP - only for RES EN50170-2/IEC61158	EtherCAT - only for RES IEC61158
Communication physical layer	not insulated USB 2.0 + USB OTG	optical insulated CAN ISO11898	optical insulated RS485	Fast Ethernet 100 Base TX
Recommended wiring cable (see 8)	LIYCY shielded cables			

Note: a minimum booting time of 500 ms has been considered from the driver energizing with the 24 Vdc power supply before the valve has been ready to operate. During this time the current to the valve coils is switched to zero

3 CONNECTIONS

3.1 REB

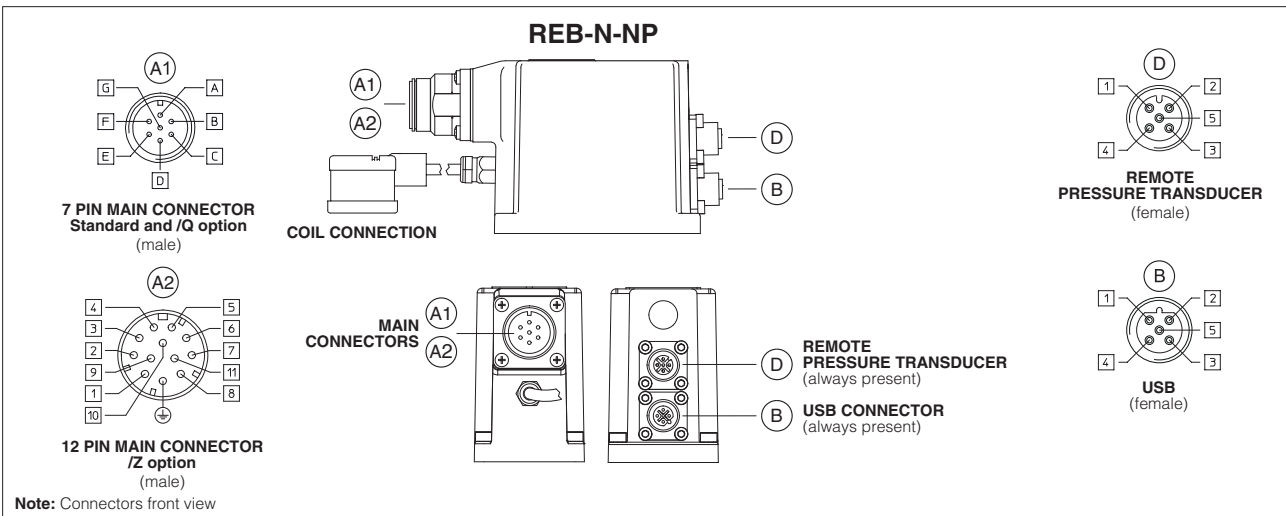

3.2 RES - CANopen BC and PROFIBUS BP

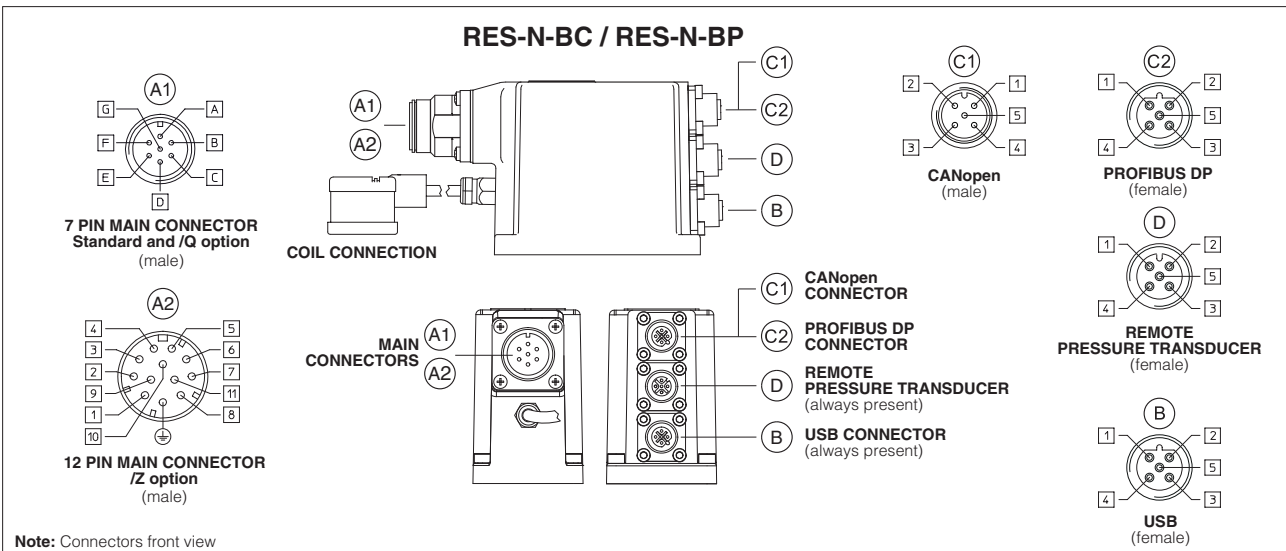

3.3 RES - EtherCAT EH

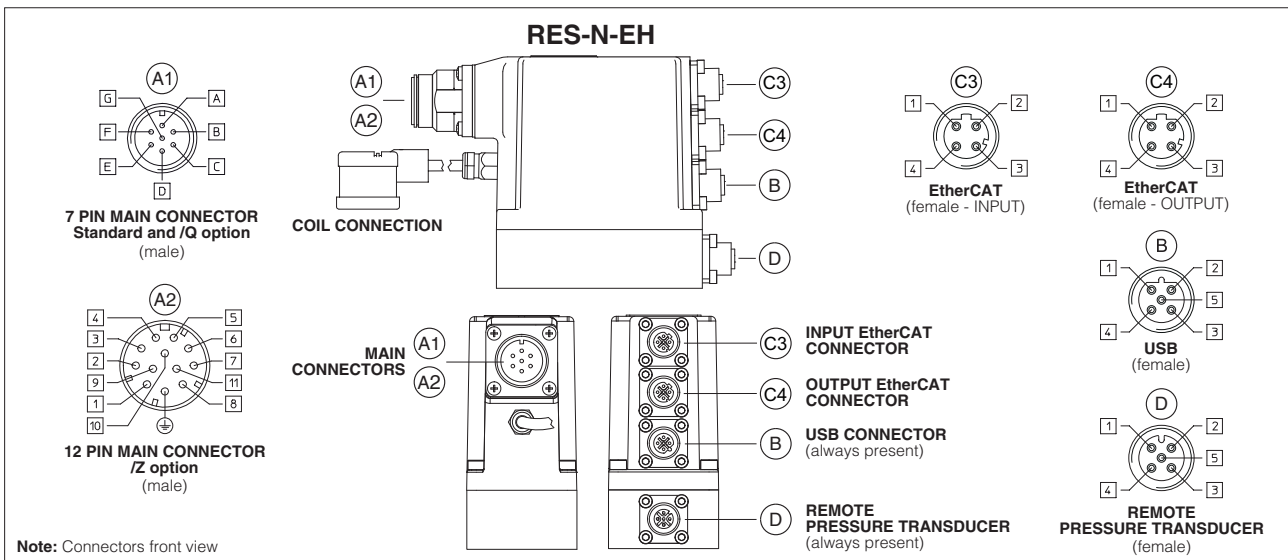

3.4 Main connector signals - 7 pin - standard and /Q options (A1) - see 8.1

PIN	Standard	/Q	TECHNICAL SPECIFICATIONS	NOTES
A	V+		Power supply 24 Vdc (see 4.1)	Input - power supply
B	V0		Power supply 0 Vdc (see 4.1)	Gnd - power supply
C	AGND		Analog ground	Gnd - analog signal
		ENABLE	Enable (24 Vdc) or disable (0 Vdc) the driver, referred to V0 (see 4.5)	Input - on/off signal
D	P_INPUT+		Pressure reference input signal: ± 10 Vdc / ± 20 mA maximum range (see 4.2)	Input - analog signal Software selectable
E	INPUT-		Negative reference input signal for P_INPUT+	Input - analog signal
F	P_MONITOR referred to: AGND V0		Pressure monitor output signal: $0 \div 10$ Vdc / $0 \div 20$ mA maximum range (see 4.3)	Output - analog signal Software selectable
G	EARTH		Internally connected to driver housing	

3.5 Main connector signals - 12 pin - /Z option (A2) - see 8.2

PIN	/Z	TECHNICAL SPECIFICATIONS	NOTES
1	V+	Power supply 24 Vdc (see 4.1)	Input - power supply
2	V0	Power supply 0 Vdc (see 4.1)	Gnd - power supply
3	ENABLE	Enable (24 Vdc) or disable (0 Vdc) the driver, referred to V0 (see 4.5)	Input - on/off signal
4	P_INPUT+	Pressure reference input signal: ± 10 Vdc / ± 20 mA maximum range (see 4.2)	Input - analog signal Software selectable
5	INPUT-	Negative reference input signal for P_INPUT+	Input - analog signal
6	P_MONITOR	Pressure monitor output signal: $0 \div 10$ Vdc / $0 \div 20$ mA maximum range, referred to V0 (see 4.3)	Output - analog signal Software selectable
7	NC	Do not connect	
8	NC	Do not connect	
9	VL+	Power supply 24 Vdc for driver's logic and communication (see 4.4)	Input - power supply
10	V0	Power supply 0 Vdc for driver's logic and communication (see 4.4)	Gnd - power supply
11	FAULT	Fault (0 Vdc) or normal working (24 Vdc), referred to V0 (see 4.6)	Output - on/off signal
PE	EARTH	Internally connected to driver housing	

3.6 Communication connectors (B) - (C) - see 8.3

(B) USB connector - M12 - 5 pin always present		
PIN	SIGNAL	TECHNICAL SPECIFICATION (1)
1	+5V_USB	Power supply
2	ID	Identification
3	GND_USB	Signal zero data line
4	D-	Data line -
5	D+	Data line +

(C1) BC fieldbus execution, connector - M12 - 5 pin (2)		
PIN	SIGNAL	TECHNICAL SPECIFICATION (1)
1	CAN_SHLD	Shield
2	NC	do not connect
3	CAN_GND	Signal zero data line
4	CAN_H	Bus line (high)
5	CAN_L	Bus line (low)

(C2) BP fieldbus execution, connector - M12 - 5 pin (2)		
PIN	SIGNAL	TECHNICAL SPECIFICATION (1)
1	+5V	Termination supply signal
2	LINE-A	Bus line (high)
3	DGND	Data line and termination signal zero
4	LINE-B	Bus line (low)
5	SHIELD	

(C3) (C4) EH fieldbus execution, connector - M12 - 4 pin (2)		
PIN	SIGNAL	TECHNICAL SPECIFICATION (1)
1	TX+	Transmitter
2	RX+	Receiver
3	TX-	Transmitter
4	RX-	Receiver
Housing	SHIELD	

Notes: (1) shield connection on connector's housing is recommended (2) only for RES execution

3.7 Remote pressure transducer connector - M12 - 5 pin (D) - see 8.4

PIN	SIGNAL	TECHNICAL SPECIFICATION	NOTES	Voltage	Current
1	VF +24V	Power supply +24Vdc	Output - power supply	Connect	Connect
2	TR	Signal transducer ± 10 Vdc / ± 20 mA maximum range - see 4.7	Input - analog signal Software selectable	Connect	Connect
3	AGND	Common gnd for transducer power and signals	Common gnd	Connect	/
4	NC	Not Connect		/	/
5	NC	Not Connect		/	/

Remote pressure transducer connection - example

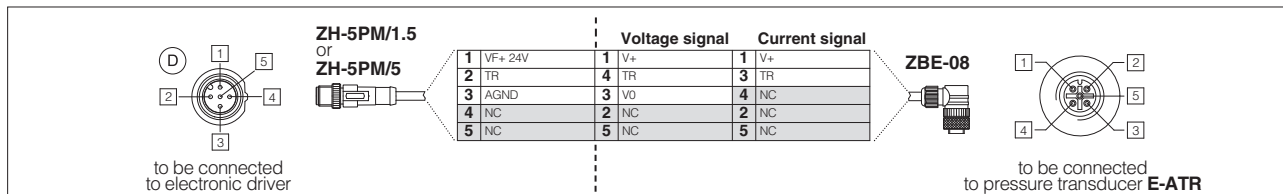

Note: connectors front view

4 SIGNALS SPECIFICATIONS

Atos proportional valves are CE marked according to the applicable directives (e.g. Immunity/Emission EMC Directive).

Installation, wirings and start-up procedures must be performed according to the general prescriptions shown in tech table **F003** and in the user manuals included in the E-SW programming software.

The electrical signals of the driver (e.g. monitor signals) must not be directly used to activate safety functions, like to switch-ON/OFF the machine's safety components, as prescribed by the European standards (Safety requirements of fluid technology systems and components-hydraulics, EN-982).

4.1 Power supply (V+ and V0)

The power supply must be appropriately stabilized or rectified and filtered: apply at least a 10000 μ F/40 V capacitance to single phase rectifiers or a 4700 μ F/40 V capacitance to three phase rectifiers.

In case of double power supply see 4.4.

A safety fuse is required in series to each power supply: 2,5 A time lag fuse.

4.2 Pressure reference input signal (P_INPUT+)

The driver controls in closed loop the current to the valve pressure proportionally to the external reference input signal.

Reference input signal is factory preset according to selected valve code, defaults are 0 \div 10 Vdc for standard and 4 \div 20 mA for /I option.

Input signal can be reconfigured via software selecting between voltage and current, within a maximum range of \pm 10 Vdc or \pm 20 mA.

Drivers with fieldbus interface (BC, BP, EH) can be software set to receive reference signal directly by the machine control unit (fieldbus reference).

Analog reference input signal can be used as on-off commands with input range 0 \div 24Vdc.

4.3 Pressure monitor output signal (P_MONITOR)

The driver generates an analog output signal proportional to the actual pressure of the valve; the monitor output signal can be software set to show other signals available in the driver (e.g. analog reference, fieldbus reference).

Monitor output signal is factory preset according to selected valve code, defaults settings are 0 \div 10 Vdc for standard and 4 \div 20 mA for /I option.

Output signal can be reconfigured via software selecting between voltage and current, within a maximum range of 0 \div 10 Vdc or 0 \div 20 mA.

4.4 Power supply for driver's logic and communication (VL+ and VL0) - only for /Z option

The power supply for driver's logic and communication must be appropriately stabilized or rectified and filtered: apply at least a 10000 μ F/40 V capacitance to single phase rectifiers or a 4700 μ F/40 V capacitance to three phase rectifiers.

The separate power supply for driver's logic on pin 9 and 10, allow to remove solenoid power supply from pin 1 and 2 maintaining active the diagnostics, USB and fieldbus communications.

A safety fuse is required in series to each driver's logic and communication power supply: 500 mA fast fuse.

4.5 Enable input signal (ENABLE) - only for /Q and /Z options

To enable the driver, supply 24 Vdc on pin 3 (pin C): Enable input signal allows to enable/disable the current supply to the solenoid, without removing the electrical power supply to the driver; it is used to active the communication and the other driver functions when the valve must be disabled for safety reasons. This condition does not comply with European Norms EN13849-1 (ex EN954-1).

4.6 Fault output signal (FAULT) - only for /Z option

Fault output signal indicates fault conditions of the driver (solenoid short circuits/not connected, reference signal broken for 4 \div 20 mA input, etc.). Fault presence corresponds to 0 Vdc, normal working corresponds to 24 Vdc.

Fault status is not affected by the Enable input signal.

4.7 Remote pressure transducer input signal (TR)

Analog pressure transducers E-ATR-8 has to be connected to the driver.

Select /C option for pressure transducer feedback 4 \div 20 mA to realize cable break alarm detection (see 6.6).

Analog input signal is factory preset according to selected valve code, defaults are 0 \div 10 Vdc for standard and 4 \div 20 mA for /C option.

Input signal can be reconfigured via software selecting between voltage and current, within a maximum range of \pm 10 Vdc or \pm 20 mA.

5 PROGRAMMING TOOLS - see tech table GS500

Valve's functional parameters and configurations, can be easily set and optimized using Atos E-SW programming software connected via USB port to the digital driver. For fieldbus versions, the software permits valve's parameterization through USB port also if the driver is connected to the central machine unit via fieldbus.

The software is available in different versions according to the driver's options:

E-SW-BASIC	support:	NP (USB)	PS (Serial)	IR (Infrared)
E-SW-FIELDBUS	support:	BC (CANopen)	BP (PROFIBUS DP)	EH (EtherCAT)
		EW (POWERLINK)	EI (EtherNet/IP)	
E-SW-*/PQ	support:	valves with SP, SF, SL alternated control (e.g. E-SW-BASIC/PQ)		

WARNING: drivers USB port is not isolated!

The use of isolator adapter is highly recommended for PC protection (see table **GS500**)

Free programming software, web download:

E-SW-BASIC web download = software can be downloaded upon web registration at www.download.atos.com ; service and DVD not included
Upon web registration user receive via email the Activation Code (software free license) and login data to access Atos Download Area

DVD programming software, to be ordered separately:

E-SW-* DVD first supply = software has to be activated via web registration at www.download.atos.com ; 1 year service included
Upon web registration user receive via email the Activation Code (software license) and login data to access Atos Download Area

E-SW-*-N DVD next supplies = only for supplies after the first; service not included, web registration not allowed
Software has to be activated with Activation Code received upon first supply web registration

Atos Download Area: direct access to latest releases of E-SW software, manuals, USB drivers and fieldbus configuration files at www.download.atos.com

USB Adapters, Cables and Terminators, can be ordered separately

USB connection

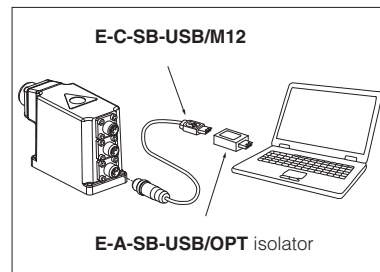

6 MAIN SOFTWARE PARAMETER SETTINGS

The following is a brief description of the main settings and features of digital drivers. For a detailed descriptions of available settings, wirings and installation procedures, please refer to the user manual included in the E-SW programming software:

E-MAN-RI-REB - user manual for **REB** basic execution

E-MAN-RI-RES - user manual for **RES** full execution

6.1 Scale

Scale function allows to set the maximum current supplied to the solenoid, corresponding to the max pressure valve regulation, at maximum reference signal value.

This regulation allows to adapt the maximum current supplied from the driver to the specific nominal current of the pressure proportional valves to which the driver is coupled; it is also useful to reduce the maximum valve regulation in front of maximum reference signal.

6.2 Bias and Threshold

Pressure proportional valves may be provided with a dead band in the hydraulic regulation corresponding to their switch-off status.

This dead band discontinuity in the pressure valve's regulation can be compensated by activating the Bias function, which adds a fixed preset Bias value to the reference signal (analog or fieldbus external input).

The Bias function is activated when the reference signal overcomes the Threshold value, preset into the driver.

The Bias setting allows to calibrate the Bias current to the specific pressure proportional valve to which the driver is coupled.

The Threshold setting is useful to avoid undesired valve regulation at zero reference signal when electric noise is present on the analog input signal: smaller threshold reduces the reference signal dead band, greater values are less affected by electric noise presence.

If fieldbus reference signal is active (see 4.2), threshold should be set to zero.

Refer to the programming manuals for a detailed description of other software selectable Bias functions.

6.3 Ramps

The ramp generator allows to convert sudden change of electronic reference signal into smooth time-dependent increasing/decreasing of the current supplied to the solenoid.

Different ramp mode can be set:

- single ramp for any reference variation
- two ramps for increasing and for decreasing reference variations

Ramp generator is useful for application where smooth hydraulic actuation is necessary to avoid machine vibration and shocks.

If the pressure proportional valve is driven by a closed loop controller, the ramps can lead to unstable behaviour, for these applications ramp function can be software disabled (default setting).

6.4 Linearization - E-SW level 2 functionality

Linearization function allows to set the relation between the reference input signal and the controlled valve's pressure regulation. Linearization is useful for applications where it is required to linearize the valve's pressure regulation in a defined working condition.

6.5 Dynamic response - 4 pressure PIDs

The valve is provided with 4 PIDs configurations to match different hydraulic conditions. The required PID configuration can be selected before the valve commissioning, through Atos E-SW software via USB port. Only for **RES** the PID can be also selected in real time, through PLC via fieldbus.

PID	Dynamic response example diagrams at side
1	Fast - default (1)
2	Standard
3	Smooth
4	Open Loop

(1) interchangeable with previous AERS version

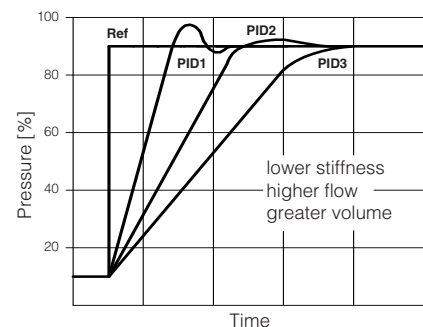
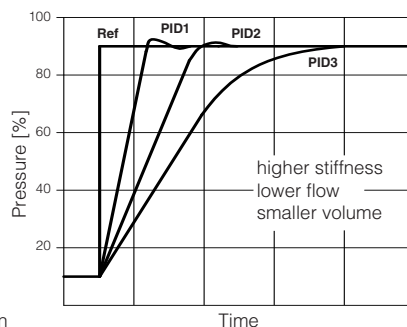

Above indications have to be considered as a general guideline, being affected by hydraulic circuit stiffness, working flow and dead volume. The valve's dynamics can be further optimized on the specific application, customizing PIDs parameters.

In case of pressure instability, select PID4 to operate the valve in open loop.

If the instability still persists, check eventual anomalies in the hydraulic circuit as the presence of air.

If the instability disappears, select an alternative configuration within PID selection 1, 2 or 3 which better matches the application requirements.

If no one of the above selection fulfills the application, tune P - I - D parameters at E-SW software level 2 to obtain the desired dynamic response.

6.6 Remote pressure transducer failure - only for IC option

In case of pressure transducer failure, only for 4 ÷ 20 mA pressure transducer feedback, the valve's reaction can be configured through Atos E-SW software to:

- cut off the current to solenoid, therefore the regulated pressure will be reduced to minimum value (default setting)
- automatically switch the pressure control from closed loop (PID1,2,3) to open loop (PID4), to let the valve to temporarily operate with reduced regulation accuracy

6.7 Remote pressure transducer factory preset

The valve is factory preset to operate with pressure transducer type E-ATR-8 having a standard measuring range specifically sized to match the valve max regulated pressure. Please refer to below table to select the correct E-ATR-8 measuring range:

Valve model	Valve max regulated pressure	E-ATR-8 standard pressure measuring range (table GS465)
RZGO	32 = 32 bar	60 = 0 ÷ 60 bar
RZGO, RZMO	100 = 100 bar	160 = 0 ÷ 160 bar
AGMZO, AGRCZO	210 = 210 bar	250 = 0 ÷ 250 bar
LIMZO, LIRZO, LICZO	315 = 315 bar	400 = 0 ÷ 400 bar
	350 = 350 bar	

In case the selected pressure transducer has a measuring range different to the above standard, the valve pressure feedback scale must be set according to the new measuring range, using E-SW software.

Please consider that a different pressure measuring range respect to the standard may cause following situations:

- selected range higher than standard = the valve regulation accuracy will be reduced in consequence of the lower pressure feedback resolution
- selected range lower than standard = the transducer could be damaged if the system pressure will exceed transducer max measuring range

6.1, 6.2 - Scale, Bias & Threshold

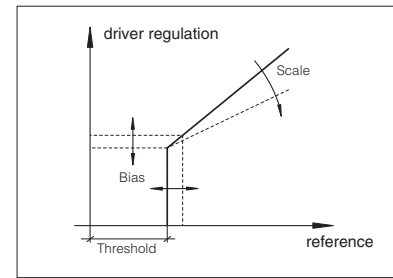

6.4 - Ramps

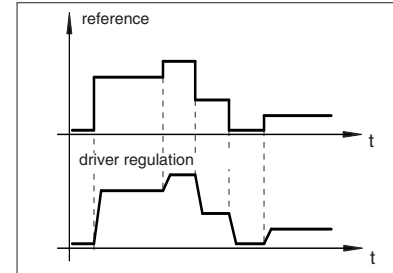

6.5 - Linearization

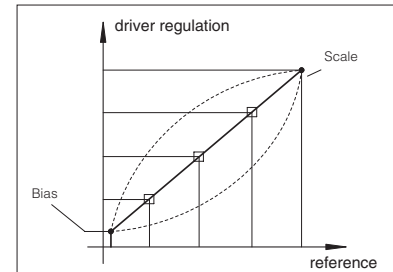

7 OVERALL DIMENSIONS [mm]

7.1 REB

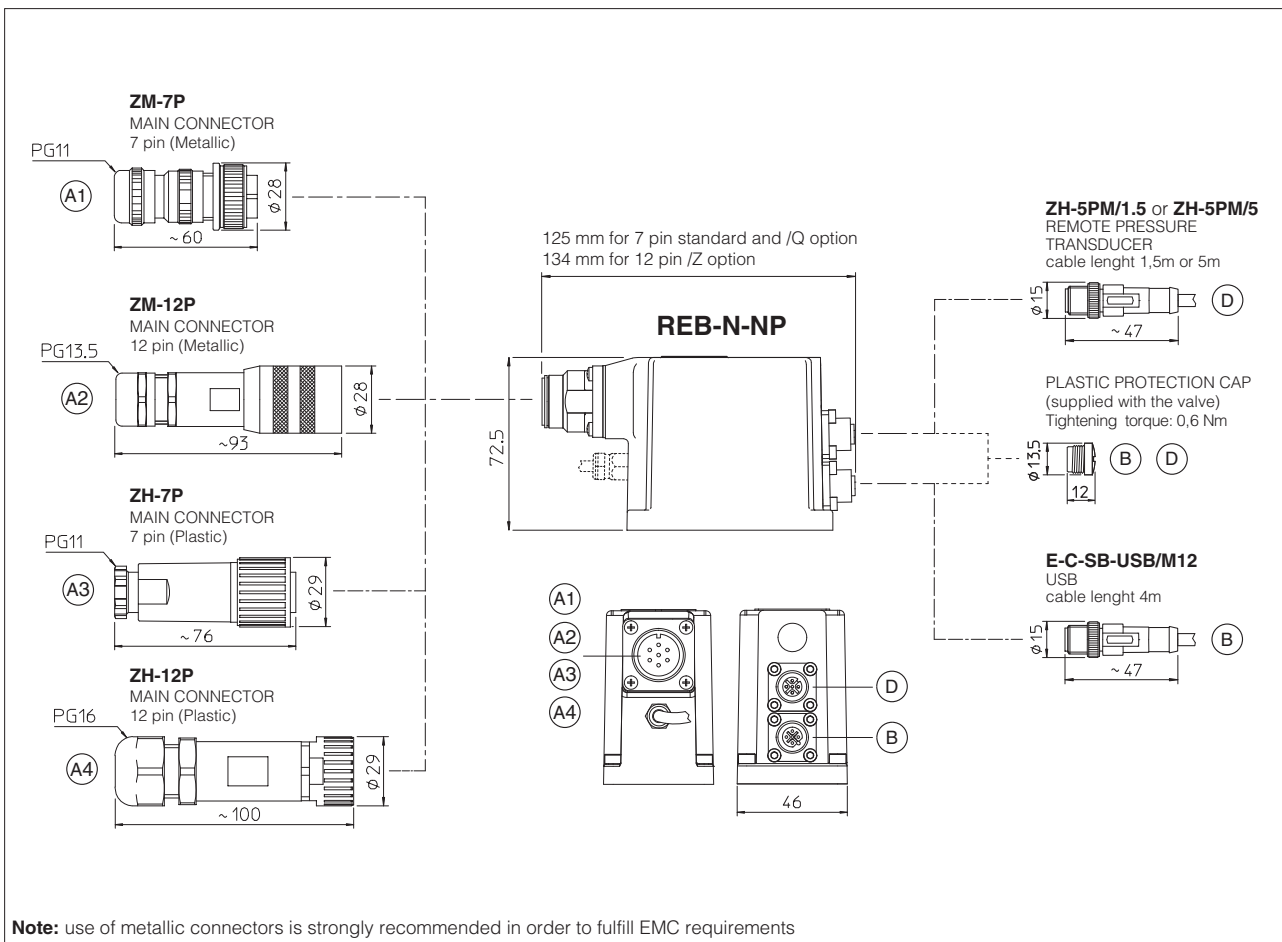

7.2 RES - CANopen BC and PROFIBUS BP

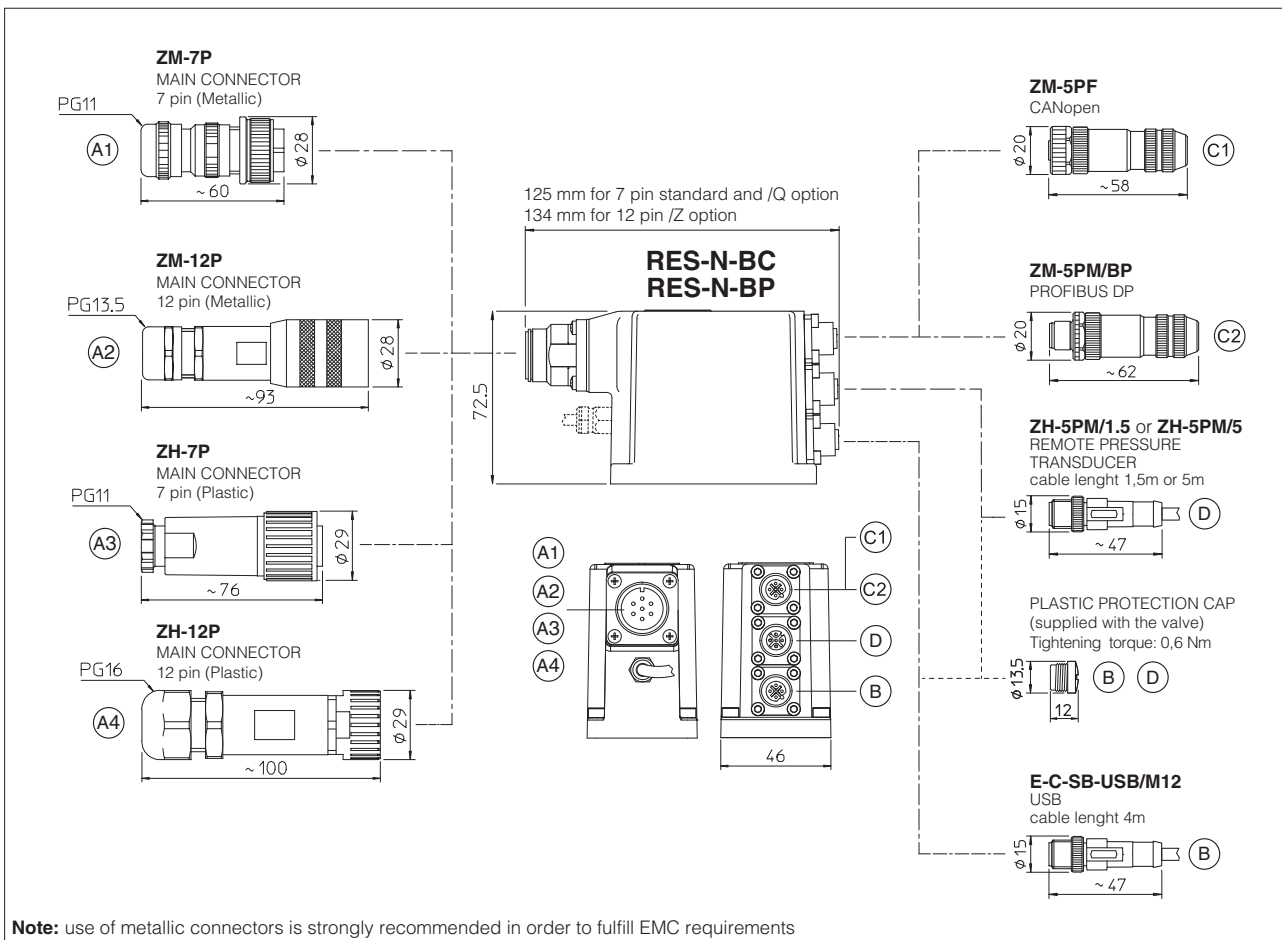

7.3 RES - EtherCAT EH

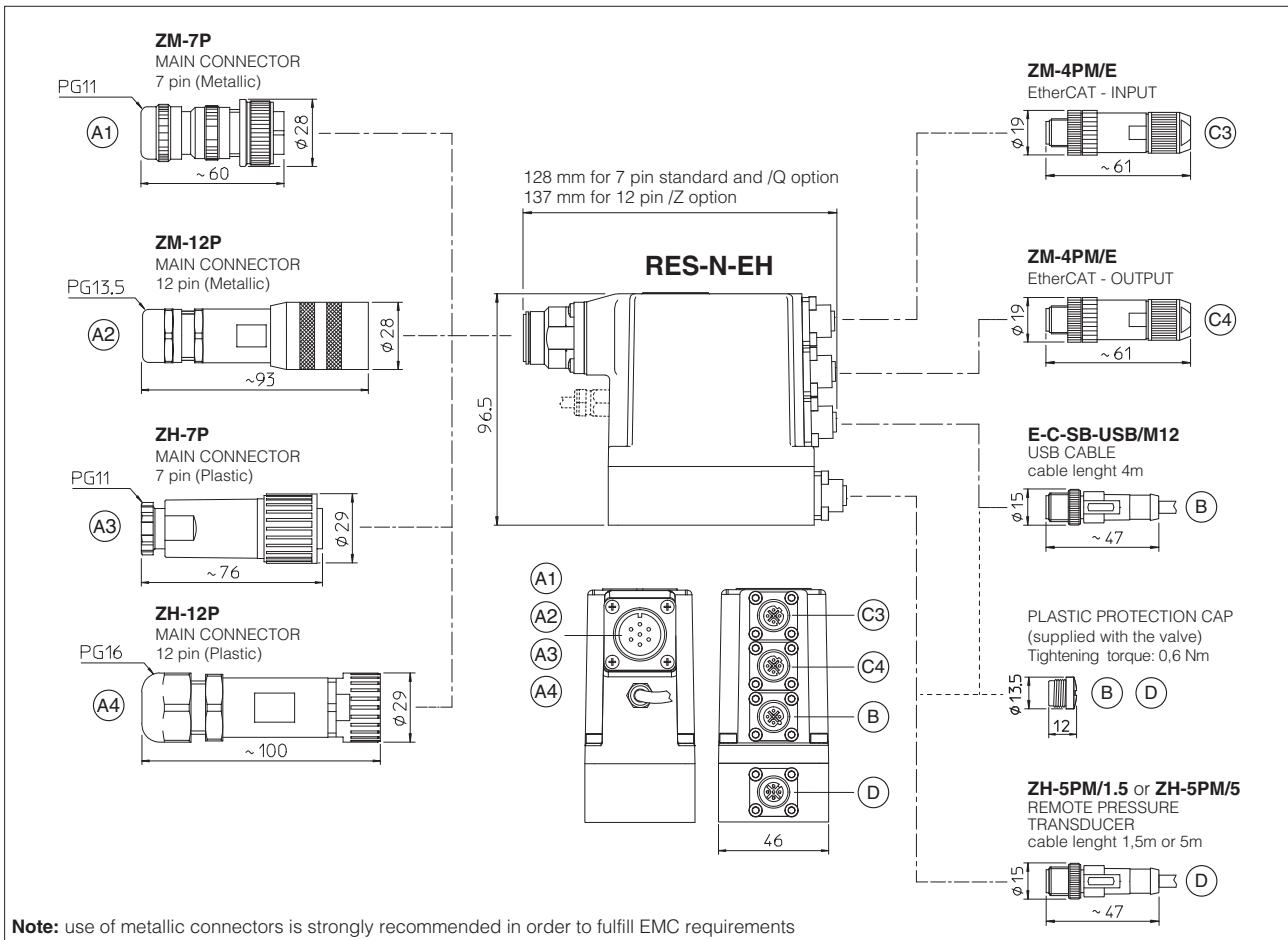

8 CONNECTORS CHARACTERISTICS - to be ordered separately

8.1 Main connectors - 7 pin

CONNECTOR TYPE	POWER SUPPLY	POWER SUPPLY
CODE	(A1) ZM-7P	(A3) ZH-7P
Type	7pin female straight circular	7pin female straight circular
Standard	According to MIL-C-5015	According to MIL-C-5015
Material	Metallic	Plastic reinforced with fiber glass
Cable gland	PG11	PG11
Recommended cable	LiYCY 7 x 0,75 mm ² max 20 m (logic and power supply) LiYCY 7 x 1 mm ² max 40 m (logic and power supply)	LiYCY 7 x 0,75 mm ² max 20 m (logic and power supply) LiYCY 7 x 1 mm ² max 40 m (logic and power supply)
Conductor size	up to 1 mm ² - available for 7 wires	up to 1 mm ² - available for 7 wires
Connection type	to solder	to solder
Protection (EN 60529)	IP 67	IP 67

8.2 Main connectors - 12 pin

CONNECTOR TYPE	POWER SUPPLY	POWER SUPPLY
CODE	(A2) ZM-12P	(A4) ZH-12P
Type	12pin female straight circular	12pin female straight circular
Standard	DIN 43651	DIN 43651
Material	Metallic	Plastic reinforced with fiber glass
Cable gland	PG13,5	PG16
Recommended cable	LiYCY 12 x 0,75 mm ² max 20 m (logic and power supply)	LiYCY 10 x 0,14mm ² max 40 m (logic) LiYY 3 x 1mm ² max 40 m (power supply)
Conductor size	0,5 mm ² to 1,5 mm ² - available for 12 wires	0,14 mm ² to 0,5 mm ² - available for 9 wires 0,5 mm ² to 1,5 mm ² - available for 3 wires
Connection type	to crimp	to crimp
Protection (EN 60529)	IP 67	IP 67

8.3 Fieldbus communication connectors - only for RES execution

CONNECTOR TYPE	BC CANopen (1)	BP PROFIBUS DP (1)	EH EtherCAT (2)
CODE	Ⓒ1 ZM-5PF	Ⓒ2 ZM-5PM/BP	Ⓒ3 Ⓒ4 ZM-4PM/E
Type	5 pin female straight circular	5 pin male straight circular	4 pin male straight circular
Standard	M12 coding A – IEC 61076-2-101	M12 coding B – IEC 61076-2-101	M12 coding D – IEC 61076-2-101
Material	Metallic	Metallic	Metallic
Cable gland	Pressure nut - cable diameter 6÷8 mm	Pressure nut - cable diameter 6÷8 mm	Pressure nut - cable diameter 4÷8 mm
Cable	CANbus Standard (DR 303-1)	PROFIBUS DP Standard	Ethernet standard CAT-5
Connection type	screw terminal	screw terminal	terminal block
Protection (EN 60529)	IP67	IP 67	IP 67

Notes: (1) E-TRM-** terminators can be ordered separately - see tech table **GS500**

(2) Internally terminated

8.4 Remote pressure transducer connector

CONNECTOR TYPE	TRANSDUCER	
CODE	Ⓓ ZH-5PM/1.5	Ⓓ ZH-5PM/5
Type	5 pin male straight circular	
Standard	M12 coding A – IEC 61076-2-101	
Material	Plastic	
Cable gland	Connector moulded on cables 1,5 m lenght 5 m lenght	
Cable	5 x 0,25 mm ²	
Connection type	molded cable	
Protection (EN 60529)	IP 67	

9 MODEL CODE FOR SPARE PARTS

Integral drivers are available as spare parts only for Atos authorized service centers.

E-RI	-	RE	-	S	-	N	-	NP	-	01H	/	*	/	*
Integral electronic driver (1)		RE = for closed loop pressure proportional valves												Set code (3)
B = basic S = full N = remote pressure transducer										Series number				
Fieldbus interface - USB port always present (2): NP = Not Present BC = CANopen BP = PROFIBUS DP EH = EtherCAT										Electronic options: Q = enable signal Z = double power supply, enable, fault and monitor signals (12 pin connector) Valve options: C = current feedback for remote transducer 4÷20 mA (omit for feedback signal 0 ÷ 10 V) - see 4.7 I = current reference input and monitor 4÷20 mA (omit for standard voltage reference input and monitor ±10 V)				
(1) for Ex-proof execution, please contact Atos technical department (2) REB available only in version NP ; RES available only in version BC, BP, EH (3) set code identifies the correspondence between the integral driver and the relevant valve; it is assigned by Atos when the driver is ordered as spare part										01H = for single solenoid proportional valves				