

Proportional pressure reducing valves type SDHRZE

direct operated, ISO 4401 size 06

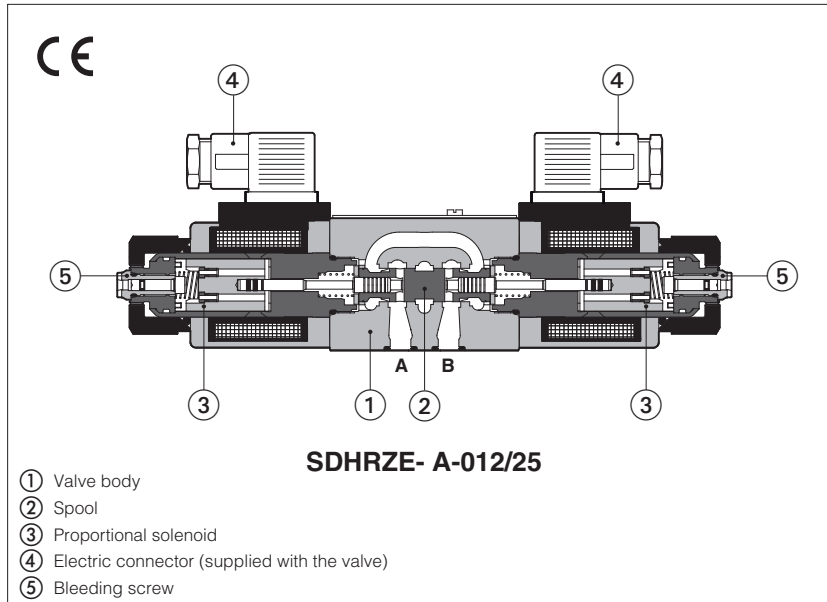

SDHRZE-A

3 way, direct operated proportional pressure reducing valves, size 06.

They operate in association with electronic drivers, see section 2, which supply the proportional solenoids with proper current to align the pressure regulation to the reference signal.

Technical characteristics

They provide the pressure reduction on ports A, or B or A and B, depending on the valve model. The direct execution performs low internal leakages, fast response and low hysteresis.

The solenoid coils are plastic encapsulated with insulation class H and they are available with different nominal resistances depending to the voltage supply (12 V_{dc} or 24 V_{dc}) and to the electronic driver type, see section 2 and 3.

Typical applications

Pressure reduction in low flow systems
Pilot stage of pilot operated valves

Mounting surface: **ISO 4401 size 06**

Max flow: **24 l/min**

Max pressure: **315 bar**

Max regulated pressure: **25 bar**

1 MODEL CODE

SDHRZE	-	A	-	010	/	25	/	*	/	*	/	**	/	*	
Proportional pressure reducing valve size 06												Series number		Seals material, see sect. 5: - = NBR PE = FKM BT = HNBR	
		A = open loop pressure control													
		Configuration:		010 = reduced pressure on port A (port B for option /B)		012 = reduced pressure on port A and B									
		Regulated pressure:		25 = reduced pressure range 3÷25 bar											
												Coil options see section 3 and 4: - = standard coil for 24V _{dc} Atos drivers 6 = optional coil for 12V _{dc} Atos drivers 18 = optional coil for 24V _{dc} low current drivers			
												Hydraulic option B = reduced pressure on port B, solenoid side of port A (only for valve configuration 010)			

HYDRAULIC SYMBOLS

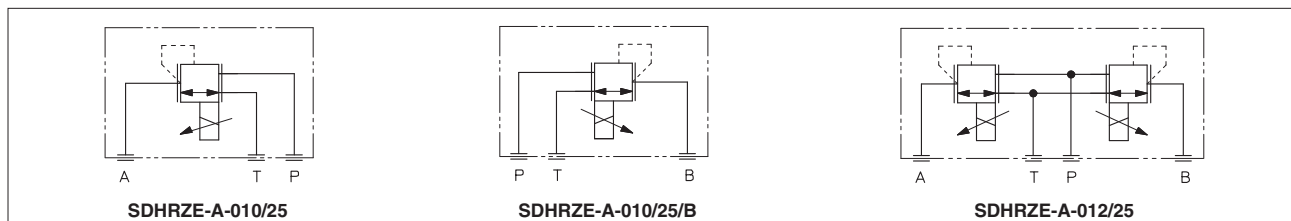

2 ELECTRONIC DRIVERS - see www.atos.com or KTI industrial master catalog

Drivers model	E-MI-AC		E-MI-AS-IR		E-BM-AS-PS		E-BM-AES
Type	analog		digital		digital		digital
Voltage supply (V _{dc})	12	24	12	24	12	24	24
Valve coil option	/6	std	/6	std	/6	std	std
Format	DIN 43650 plug-in to solenoid				DIN-rail panel		
Data sheet	G010		G020		G030		GS050

3 COIL OPTIONS

Coil voltage

Option /6 optional coil to be used with Atos drivers with power supply 12 Vdc

Option /18 optional coil to be used with electronic drivers not supplied by Atos

4 MAIN CHARACTERISTICS - based on mineral oil ISO VG 46 at 50 °C

Assembly position / location	Any position		
Subplate surface finishing (RZME)	Roughness index Ra 0,4 - flatness ratio 0,01/100 (ISO 1101)		
MTTFd valves according to EN ISO 13849	150 years, for further details see technical table P007		
Ambient temperature	Standard and /PE option = -20°C ÷ +70°C; /BT option = -40°C ÷ +60°C		
Storage temperature	Standard and /PE option = -20°C ÷ +80°C; /BT option = -40°C ÷ +70°C		
Coil code	Standard standard coil to be used with Atos drivers with power supply 24Vdc	option /6 optional coil to be used with Atos drivers with power supply 12 Vdc	option /18 optional coil to be used with electronic drivers not supplied by Atos, with power supply 24 Vdc and max current limited to 1A
Coil resistance R at 20°C	3,1 Ω	2,1 Ω	13,1 Ω
Max. solenoid current	2,5 A	3 A	1,2 A
Max. power	30 Watt		
Protection degree (CEI EN-60529)	IP65		
Duty factor	Continuous rating (ED=100%)		

Max regulated pressure (Q=1 l/min) [bar]	25
Min. regulated pressure (Q=1 l/min) (1) [bar]	3
Max. pressure at port P [bar]	315
Max. pressure at port T [bar]	210
Max. flow [l/min]	24
Response time 0-100% step signal (2) (depending on installation) [ms]	≤ 45
Hysteresis [% of the max pressure]	≤ 1,5
Linearity [% of the max pressure]	≤ 3
Repeatability [% of the max pressure]	≤ 2

Notes: above performance data refer to valves coupled with Atos electronic drivers, see section 2

(1) Min pressure value to be increased of T line pressure

(2) Average response time value; the pressure variation in consequence of a modification of the reference input signal to the valve is affected by the stiffness of the hydraulic circuit: greater is the stiffness of the circuit, faster is the dynamic response

5 SEALS AND HYDRAULIC FLUID - for other fluids not included in below table, consult our technical office

Seals, recommended fluid temperature	NBR seals (standard) = -20°C ÷ +80°C, with HFC hydraulic fluids = -20°C ÷ +50°C FKM seals (/PE option) = -20°C ÷ +80°C HNBR seals (/BT option) = -40°C ÷ +60°C, with HFC hydraulic fluids = -40°C ÷ +50°C		
Recommended viscosity	20 ÷ 100 mm ² /s - max allowed range 15 ÷ 380 mm ² /s		
Max fluid contamination level	normal operation longer life	ISO4406 class 18/16/13 ISO4406 class 16/14/11	NAS1638 class 7 NAS1638 class 5
			see also filter section at www.atos.com or KTF catalog
Hydraulic fluid	Suitable seals type	Classification	Ref. Standard
Mineral oils	NBR, FKM, HNBR	HL, HLP, HLPD, HVLP, HVLPD	DIN 51524
Flame resistant without water	FKM	HFDU, HFDR	ISO 12922
Flame resistant with water	NBR, HNBR	HFC	

6 GENERAL NOTES

DHRZE proportional valves are CE marked according to the applicable Directives (e.g. Immunity/Emission EMC Directive and Low Voltage Directive).

7 CONNECTIONS

SOLENOID POWER SUPPLY CONNECTOR TYPE 666	
PIN	Signal description
1	SUPPLY
2	SUPPLY
3	GND

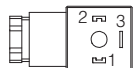

8 DIAGRAMS based on mineral oil ISO VG 46 at 50°C

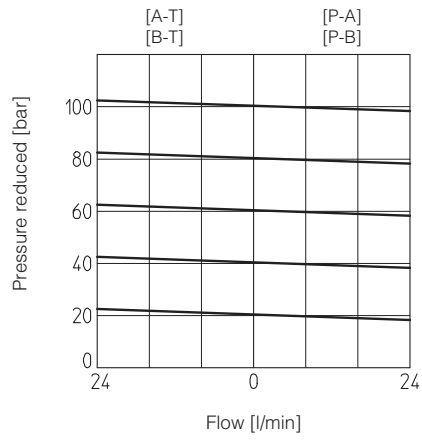
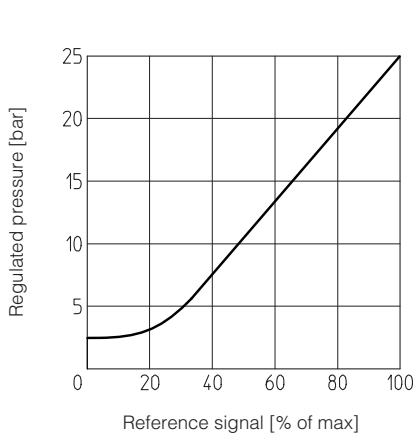

9 INSTALLATION DIMENSIONS FOR SDHRZE [mm]

ISO 4401: 2005

Mounting surface: 4401-03-02-0-05

Fastening bolts: 4 socket head screws M5x30 class 12.9

Tightening torque = 8 Nm

Seals: 4 OR 108;

Diameter of ports A, B, P, T: Ø 7,5 mm (max)

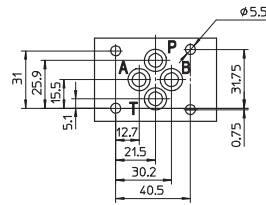

SDHRZE-A-010

SDHRZE-A-010/B

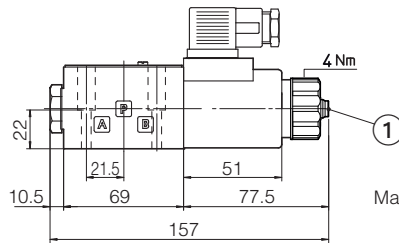
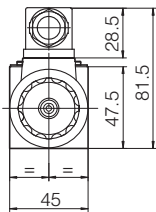

Mass: 1,9 kg

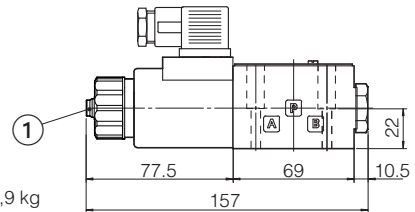

SDHRZE-A-012

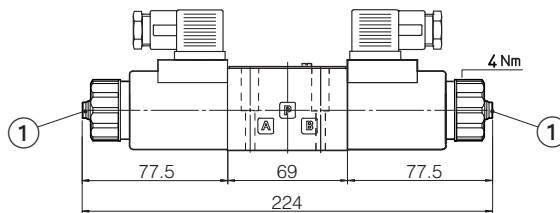

Mass: 2,6 kg

① screw for air bleeding