

# Digital proportional directional valves high performance

piloted, with on-board driver, LVDT transducer and positive spool overlap, max pressure 280 bar

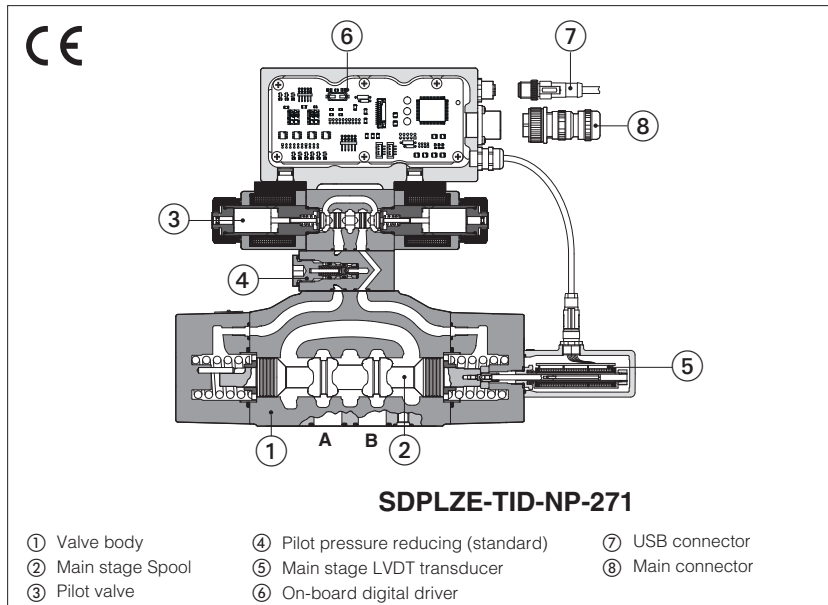

## SDPLZE-TID

Digital high performances proportional directional valves, piloted, with LVDT position transducer (main stage) and positive spool overlap for directional controls and not compensated flow regulations.

**TID** on board digital driver performs the valve's hydraulic regulation according to the reference signal sent to the 7 pin main connector.

The software setting of functional parameters can be performed via USB port.

The LVDT transducer grants high regulation accuracy and response sensitivity.

With de-energized proportional solenoids, the mechanical central position of the spool is performed by centering springs.

Size: **16 ÷ 25** - ISO 4401  
 4/3 way with standard spools  
 4/4 way with regenerative spools  
 Max flow: **400 ÷ 1000 l/min**  
 Max pressure: **280 bar**

### 1 MODEL CODE OF STANDARD SPOOLS

<b>SDPLZE</b>	-	<b>TID</b>	-	<b>NP</b>	-	<b>2</b>	-	<b>71</b>	-	<b>L</b>	-	<b>5</b>	/	<b>*</b>	/	<b>*</b>
Proportional directional valve, piloted																
<b>TID</b> = on-board digital driver and LVDT transducer																
<b>Fieldbus interfaces</b> , USB port always present: <b>NP</b> = Not present																
<b>Valve size ISO 4401:</b> <b>2</b> = 16 <b>4</b> = 25																
<b>Seals material</b> , see sect. <b>8</b> : - = NBR PE = FKM																
<b>Options</b> , see sect. <b>10</b> ( <b>2</b> ) : <b>B</b> = On-board digital driver, connection and LVDT transducer at side of port A of the main stage (side B of pilot valve)																
<b>Spool size:</b> <b>3</b> (L,S,D) <b>5</b> (L,DL,S,D) SDPLZE-2 =                    160                                    250 SDPLZE-4 =                    -    480 Nominal flow (l/min) at Δp 10 bar P-T																

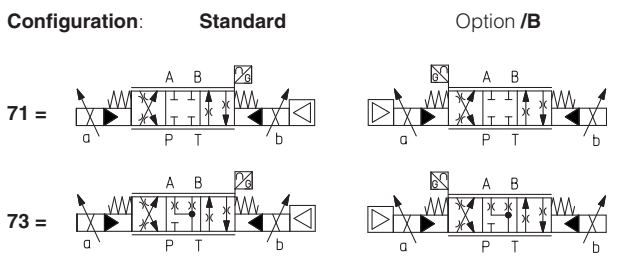

### Spool type, regulating characteristics (1):

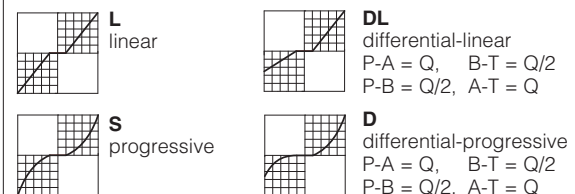

(1) Spool for regenerative circuit, see section **2**

(2) Pilot and Drain configuration: standard configuration is internal pilot and external drain, other configurations on request

**2 MODEL CODE OF SPOOLS FOR REGENERATIVE CIRCUIT** - for valve model code and options, see section **1**

**SDPLZE** - **TID** - **NP** - **2** **71 - L9** / \* \* / \*

**Configuration and spool:**

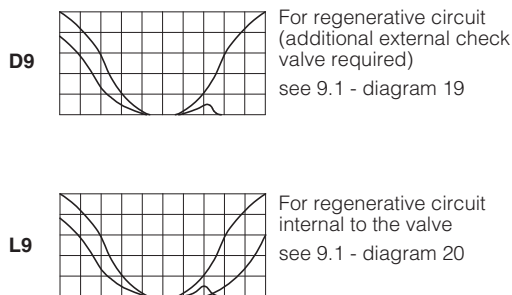
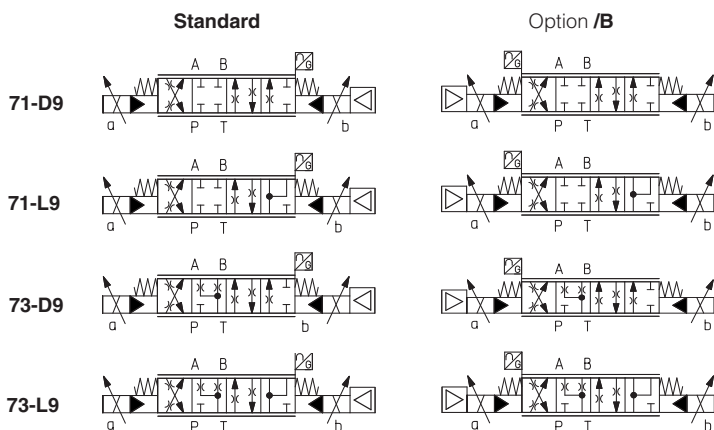

Spool size:	D9	L9
SDPLZE-2 =	250	250
SDPLZE-4 =	480	-

Nominal flow (l/min) at  $\Delta p$  10 bar P-T

**3 GENERAL NOTES**

Atos digital proportionals valves are CE marked according to the applicable directives (e.g. Immunity and Emission EMC Directive). Installation, wirings and start-up procedures must be performed according to the general prescriptions shown in tech table **FS900** and in the user manuals included in the E-SW-\* programming software.

**4 VALVE SETTINGS AND PROGRAMMING TOOLS**

Valve's functional parameters and configurations, can be easily set and optimized using Atos E-SW-BASIC programming software connected via USB port to the digital driver.

**WARNING: drivers USB port is not isolated!** For E-C-SB-USB/M12 cable, the use of isolator adapter is highly recommended for PC protection

**USB or Bluetooth connection**

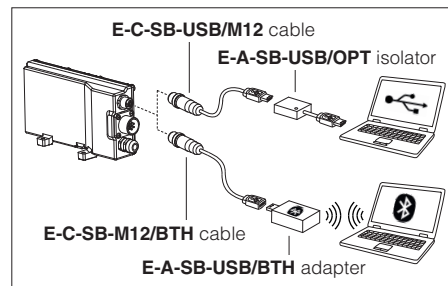

**5 GENERAL CHARACTERISTICS**

Assembly position	Any position
Subplate surface finishing to ISO 4401	Acceptable roughness index: $R_a \leq 0,8$ , recommended $R_a 0,4$ – Flatness ratio 0,01/100
MTTFd valves according to EN ISO 13849	75 years, see technical table P007
Ambient temperature range	<b>Standard</b> = $-20^\circ\text{C} \div +60^\circ\text{C}$ <b>/PE option</b> = $-20^\circ\text{C} \div +60^\circ\text{C}$
Storage temperature range	<b>Standard</b> = $-20^\circ\text{C} \div +70^\circ\text{C}$ <b>/PE option</b> = $-20^\circ\text{C} \div +70^\circ\text{C}$
Surface protection	Zinc coating with black passivation (body), tin plating (driver housing)
Corrosion resistance	Salt spray test (EN ISO 9227) > 200 h
Compliance	CE according to EMC directive 2014/30/EU (Immunity: EN 61000-6-2; Emission: EN 61000-6-3) RoHS Directive 2011/65/EU as last update by 2015/863/EU REACH Regulation (EC) n°1907/2006

**6 HYDRAULIC CHARACTERISTICS** - based on mineral oil ISO VG 46 at 50 °C

Valve model	<b>SDPLZE-*-2</b>		<b>SDPLZE-*-4</b>
Pressure limits [bar]	ports <b>P, A, B, X</b> = 280; <b>T</b> = 210 (10 for option /D); <b>Y</b> = 10;		
Spool type <b>(1)</b>	standard	<b>L3, S3, D3</b>	<b>L5, DL5, S5, D5</b>
	regenerative		<b>D9, L9</b>
Nominal flow $\Delta p$ P-T <b>(2)</b> [l/min]	$\Delta p = 10$ bar	160	480
	$\Delta p = 30$ bar	270	830
	Max permissible flow	400	1000
Piloting pressure [bar]	min. = 25; max = 280		
Piloting volume [cm <sup>3</sup> ]	3,7		9,0
Piloting flow <b>(3)</b> [l/min]	3,7		6,8
Leakage <b>(4)</b>	Pilot [l/min]	0,1 / 0,25	
	Main stage [l/min]	0,2 / 0,5	
Response time <b>(5)</b> [ms]	$\leq 75$		$\leq 90$
Hysteresis	$\leq 1$ [% of max regulation]		
Repeatability	$\pm 0,5$ [% of max regulation]		
Thermal drift	zero point displacement < 1% at $\Delta T = 40^\circ C$		

**(1)** For spool type **D** and **DL** the flow value is referred to single path P-A (A-T) at  $D_p/2$  per control edge. The flow P-B (B-T) is 50% of P-A (A-T)

**(2)** For different  $D_p$ , the max flow is in accordance to the diagrams in section 9.2

**(3)** With step reference input signal 0 ÷ 100 %

**(4)** At  $p = 100/280$  bar

**(5)** 0-100% step signal see detailed diagrams in section 9.3

**7 ELECTRICAL CHARACTERISTICS**

Power supplies	Nominal : +24 VDC Rectified and filtered : $V_{RMS} = 20 \div 32 V_{MAX}$ (ripple max 10 % VPP)
Max power consumption	50 W
Max. solenoid current	2,6 A
Coil resistance R at 20°C	3,1 $\Omega$
Analog input signals	Voltage: range $\pm 10$ VDC (24 VMAX tollerant) Input impedance: $R_i > 50$ k $\Omega$
Monitor outputs	Output range: voltage $\pm 10$ VDC @ max 5 mA
Alarms	Solenoid not connected/short circuit, cable break with current reference signal, over/under temperature, valve spool transducer malfunctions, alarms history storage function
Insulation class	H (180°) Due to the occurring surface temperatures of the solenoid coils, the European standards ISO 13732-1 and EN982 must be taken into account
Protection degree to DIN EN60529	IP66 / IP67 with mating connectors
Duty factor	Continuous rating (ED=100%)
Additional characteristics	Short circuit protection of solenoid's current supply; spool position control by P.I.D. with rapid solenoid switching; protection against reverse polarity of power supply
Communication interface	USB - Atos ASCII coding
Communication physical layer	not insulated - USB 2.0 + USB OTG
Recommended wiring cable	LiYCY shielded cables, see section <b>13</b>

**Note:** a maximum time of 400 ms have be considered between the driver energizing with the 24 Vdc power supply and when the valve is ready to operate. During this time the current to the valve coils is switched to zero.

**8 SEALS AND HYDRAULIC FLUIDS** - for other fluids not included in below table, consult our technical office

Seals, recommended fluid temperature	NBR seals (standard) = -20°C ÷ +60°C, with HFC hydraulic fluids = -20°C ÷ +50°C FKM seals (/PE option) = -20°C ÷ +80°C		
Recommended viscosity	20 ÷ 100 mm <sup>2</sup> /s - max allowed range 15 ÷ 380 mm <sup>2</sup> /s		
Max fluid contamination level	normal operation	ISO4406 class 18/16/13 NAS1638 class 7	see also filter section at <a href="http://www.atos.com">www.atos.com</a> or KTF catalog
	longer life	ISO4406 class 16/14/11 NAS1638 class 5	
<b>Hydraulic fluid</b>	<b>Suitable seals type</b>	<b>Classification</b>	<b>Ref. Standard</b>
Mineral oils	NBR, FKM	HL, HLP, HLPD, HVLP, HVLPD	DIN 51524
Flame resistant without water	FKM	HFDU, HFDR	ISO 12922
Flame resistant with water	NBR	HFC	

**9 DIAGRAMS** (based on mineral oil ISO VG 46 at 50 °C)

**9.1 Regulation diagrams** (values measure at p 10 bar P-T)

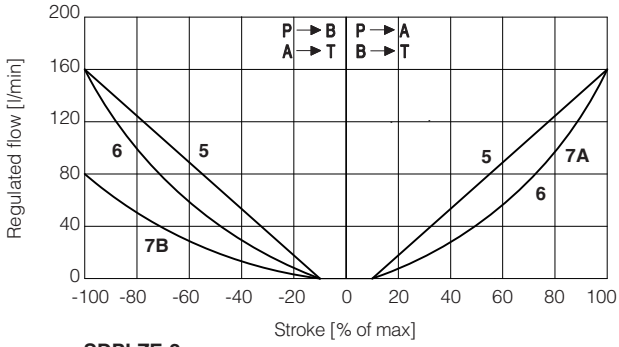

**SDPLZE-2:**

**5** = L3 **7A** = D3 (P → A, A → T)  
**6** = S3 **7B** = D3 (P → B, B → T)

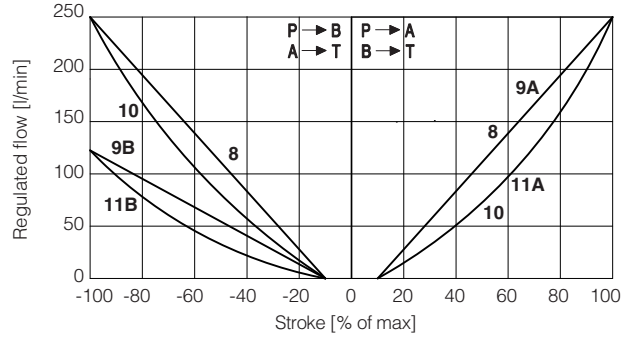

**SDPLZE-2:**

**8** = L5 **9A** = DL5 (P → A, A → T) **11A** = D5 (P → A, A → T)  
**10** = S5 **9B** = DL5 (P → B, B → T) **11B** = D5 (P → B, B → T)

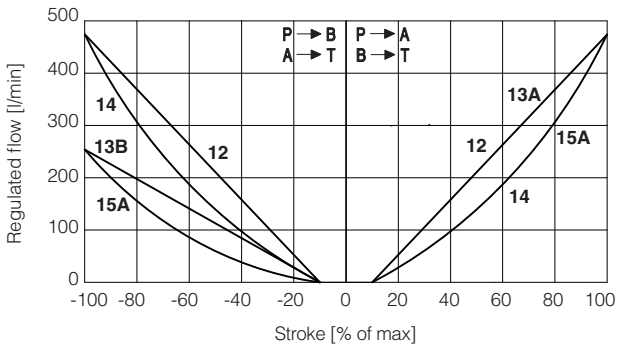

**SDPLZE-4:**

**12**=L5 **13A**=DL5 (P → A, A → T) **15A**=D5 (P → A, A → T)  
**14**=S5 **13B**=DL5 (P → B, B → T) **15B**=D5 (P → B, B → T)

**Note:**

Hydraulic configuration vs. reference signal (standard and option /B)

Reference signal  $\begin{matrix} 0 \div +10 \text{ V} \\ 12 \div 20 \text{ mA} \end{matrix} \left. \vphantom{\begin{matrix} 0 \div +10 \text{ V} \\ 12 \div 20 \text{ mA} \end{matrix}} \right\} P \rightarrow A / B \rightarrow T$

Reference signal  $\begin{matrix} 0 \div -10 \text{ V} \\ 12 \div 4 \text{ mA} \end{matrix} \left. \vphantom{\begin{matrix} 0 \div -10 \text{ V} \\ 12 \div 4 \text{ mA} \end{matrix}} \right\} P \rightarrow B / A \rightarrow T$

**16** = differential - regenerative spool **D9**  
 (not available for valve size 32)

D9 spool type with a fourth position specific to regenerative circuit, performed by means of an additional external check valve.

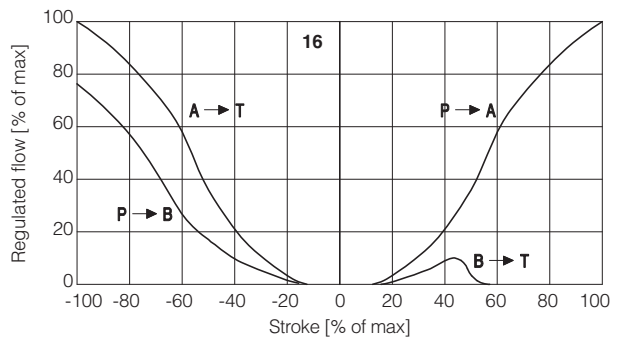
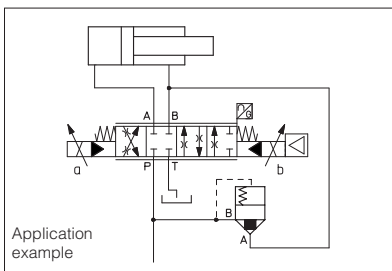

**17** = linear - internal regenerative spool **L9**  
 (available only for valve size 16)

L9 spool type with a fourth position specific to perform a regenerative circuit internal to the valve.

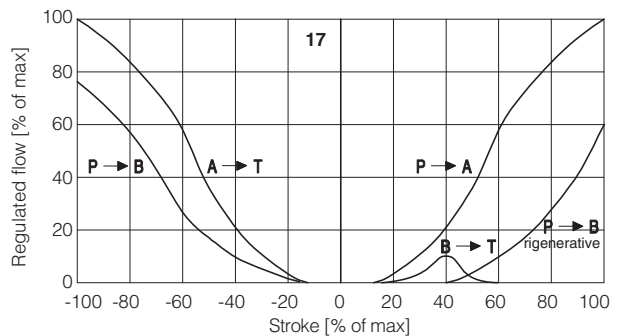

## 9.2 Operating diagrams

Flow / $\Delta p$  diagram stated at 100% of spool stroke

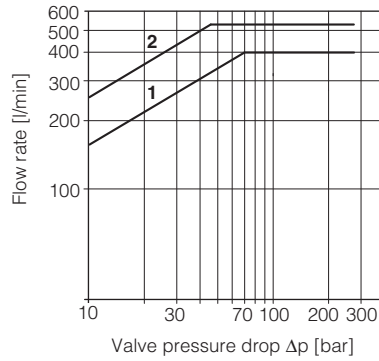

**SDPLZE-2:**  
**1** = spools L3, S3, D3  
**2** = spools L5, S5, D5, DL5, D9, L9

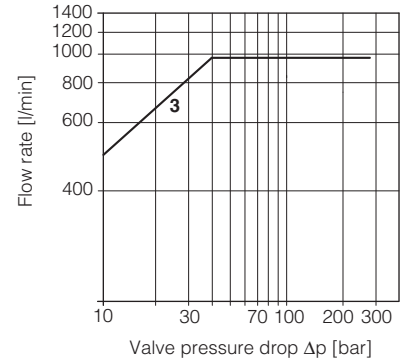

**SDPLZE-4:**  
**3** = spools L5, S5, D5, DL5, D9

## 9.3 Response time

The response times in below diagrams are measured at different steps of the reference input signal. They have to be considered as average values.

For the valves with digital electronics the dynamics performances can be optimized by setting the internal software parameters.

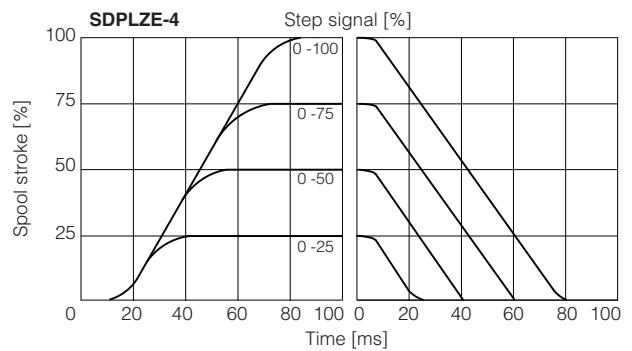
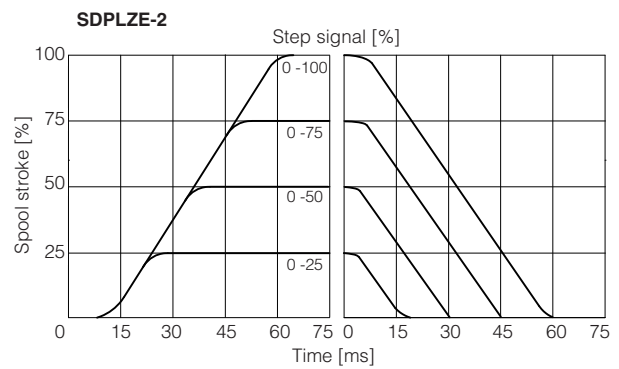

## 10 OPTIONS

**B** = Configurations 71, 73: on-board digital driver connections and LVDT transducer at side of port A of the main stage (side B of pilot valve).  
 For hydraulic configuration vs reference signal, see 9.1

### Functional Scheme

example of configuration 71

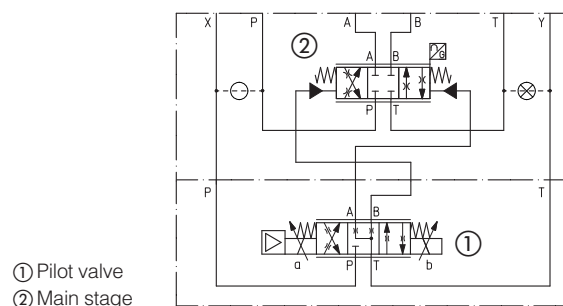

## 11 POWER SUPPLY AND SIGNALS SPECIFICATIONS

Generic electrical output signals of the valve (e.g. monitor signal) must not be directly used to activate safety functions, like to switch-ON/OFF the machine's safety components, as prescribed by the European standards (Safety requirements of fluid technology systems and components-hydraulics, EN-982).

### 11.1 Power supply (V+ and V0)

The power supply must be appropriately stabilized or rectified and filtered: apply at least a 10000  $\mu$ F/40 V capacitance to single phase rectifiers or a 4700  $\mu$ F/40 V capacitance to three phase rectifiers.



A safety fuse is required in series to the power supply: 2,5 A time lag fuse.

### 11.2 Flow reference input signal (Q\_INPUT+)

The driver controls in closed loop the valve spool position proportionally to the external reference input signal.  
Default range is  $\pm 10$  Vdc

### 11.3 Flow monitor output signal (Q\_MONITOR)

The driver generates an analog output signal proportional to the actual spool position of the valve; the monitor output signal can be software set to show other signals available in the driver.  
Default range is  $\pm 10$  VDC

**Note:** Flow referenece input signal and flow monitor output signal can be software selected with max range  $\pm 10$  Vdc

## 12 ELECTRONIC CONNECTIONS

### 12.1 Main connector signals - 7 pin <sup>(A1)</sup>

PIN	SIGNAL	TECHNICAL SPECIFICATIONS	NOTES
A	V+	Power supply 24 Vdc	Input - power supply
B	V0	Power supply 0 Vdc	Gnd - power supply
C	AGND	Analog ground	Gnd - analog signal
D	Q_INPUT+	Flow reference input signal: $\pm 10$ Vdc maximum range Default is: $\pm 10$ Vdc	Input - analog signal
E	INPUT-	Negative reference input signal for Q_INPUT+	Input - analog signal
F	Q_MONITOR	Flow monitor output signal: $\pm 10$ Vdc maximum range, referred to AGND Default is: $\pm 10$ Vdc	Output - analog signal
G	EARTH	Internally connected to driver housing	

### 12.2 Communication connectors <sup>(B)</sup>

<sup>(B)</sup> USB connector - M12 - 5 pin always present		
PIN	SIGNAL	TECHNICAL SPECIFICATION (1)
1	+5V_USB	Power supply
2	ID	Identification
3	GND_USB	Signal zero data line
4	D-	Data line -
5	D+	Data line +

### 12.3 Connections layout

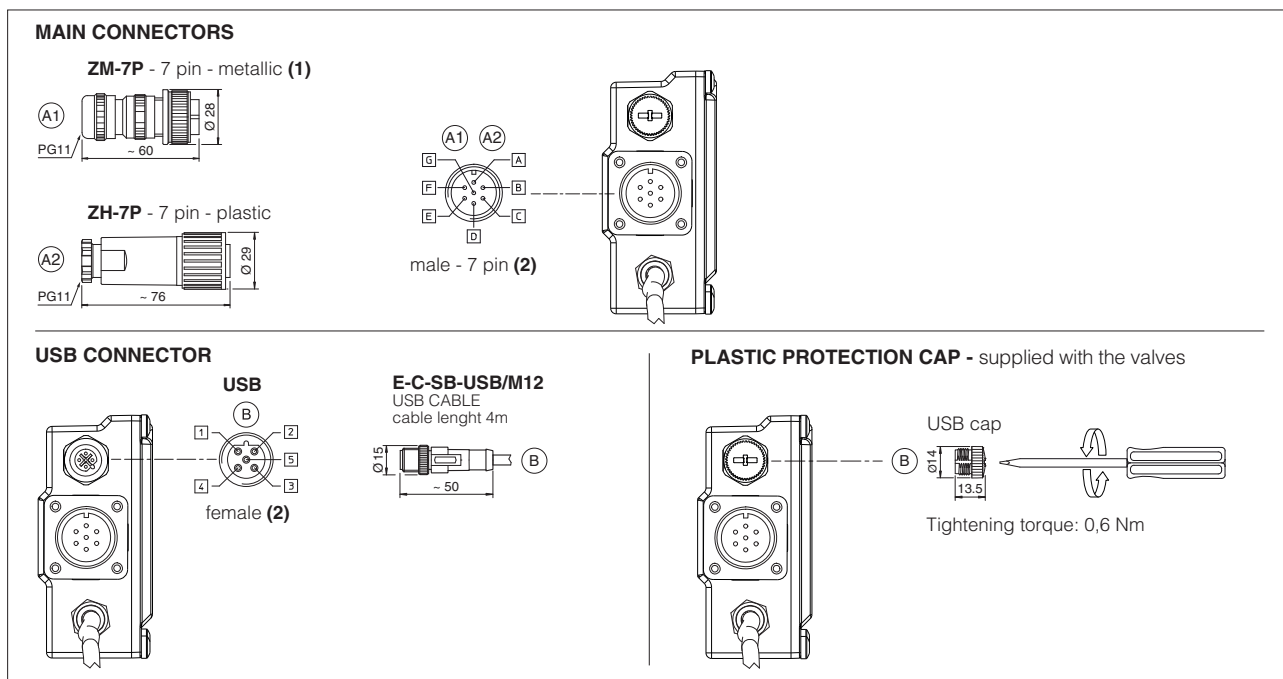

<sup>(1)</sup> use of metallic connectors is strongly recommended in order to fulfill EMC requirements

<sup>(2)</sup> pin layout always referred to driver's view

**13 CONNECTORS CHARACTERISTICS** - to be ordered separately

CONNECTOR TYPE	POWER SUPPLY	POWER SUPPLY
CODE	(A1) <b>ZM-7P</b>	(A2) <b>ZH-7P</b>
Type	7pin female straight circular	7pin female straight circular
Standard	According to MIL-C-5015	According to MIL-C-5015
Material	Metallic	Plastic reinforced with fiber glass
Cable gland	PG11	PG11
Recommended cable	LiYCY 7 x 0,75 mm <sup>2</sup> max 20 m (logic and power supply) or LiYCY 7 x 1 mm <sup>2</sup> max 40 m (logic and power supply)	LiYCY 7 x 0,75 mm <sup>2</sup> max 20 m (logic and power supply) or LiYCY 7 x 1 mm <sup>2</sup> max 40 m (logic and power supply)
Conductor size	up to 1 mm <sup>2</sup> - available for 7 wires	up to 1 mm <sup>2</sup> - available for 7 wires
Connection type	to solder	to solder
Protection (EN 60529)	IP 67	IP 67

**14 FASTENING BOLTS AND SEALS**

Type	Size	Fastening bolts	Seals
SDPLZE	2 = 16	4 socket head screws M10x50 class 12.9 Tightening torque = 70 Nm  2 socket head screws M6x45 class 12.9 Tightening torque = 15 Nm	4 OR 130; Diameter of ports A, B, P, T: Ø 20 mm (max)  2 OR 2043 Diameter of ports X, Y: Ø = 7 mm (max)
	4 = 25	6 socket head screws M12x60 class 12.9 Tightening torque = 125 Nm	4 OR 4112; Diameter of ports A, B, P, T: Ø 24 mm (max)  2 OR 3056 Diameter of ports X, Y: Ø = 7 mm (max)

**15 INSTALLATION DIMENSIONS [mm]**

**SDPLZE-TID-NP-2\***

Mass [kg]	
SDPLZE-*-27	14,8

ISO 4401: 2005  
Size 16  
Mounting surface: 4401-07-07-0-05

**SDPLZE-TID-NP-27\***

**SDPLZE-TID-NP-27\*/B**

① = Space to remove the connectors  
② = The dimensions of all connectors must be considered, see section 12.3

## SDPLZE-TID-NP-4\*

ISO 4401: 2005

Size 25

Mounting surface: 4401-08-08-0-05  
(see table P005)

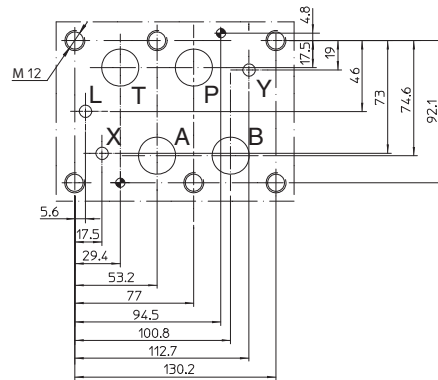

## SDPLZE-TID-NP-47\*

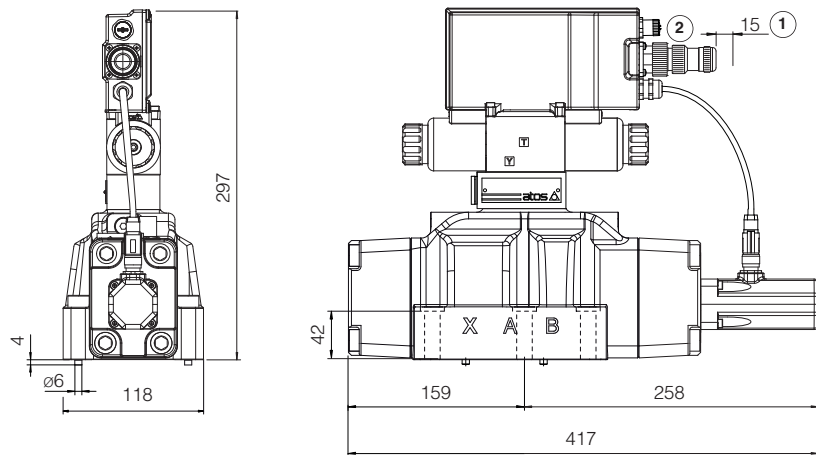

## SDPLZE-TID-NP-47\*/B

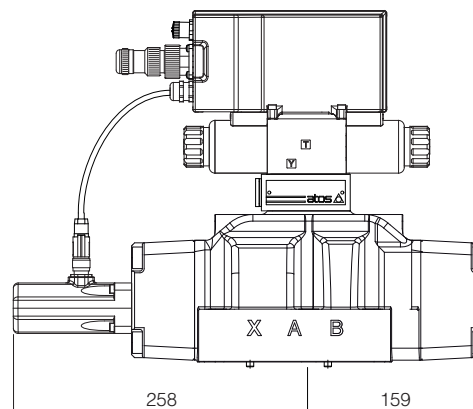

Mass [kg]	
SDPLZE-*-47	19,3

① = Space to remove the connectors

② = The dimensions of all connectors must be considered, see section 12.3