

Analog electronic E-RP-AC drivers

sealed and rugged box, for proportional valves without transducer

obsolete components - availability on request

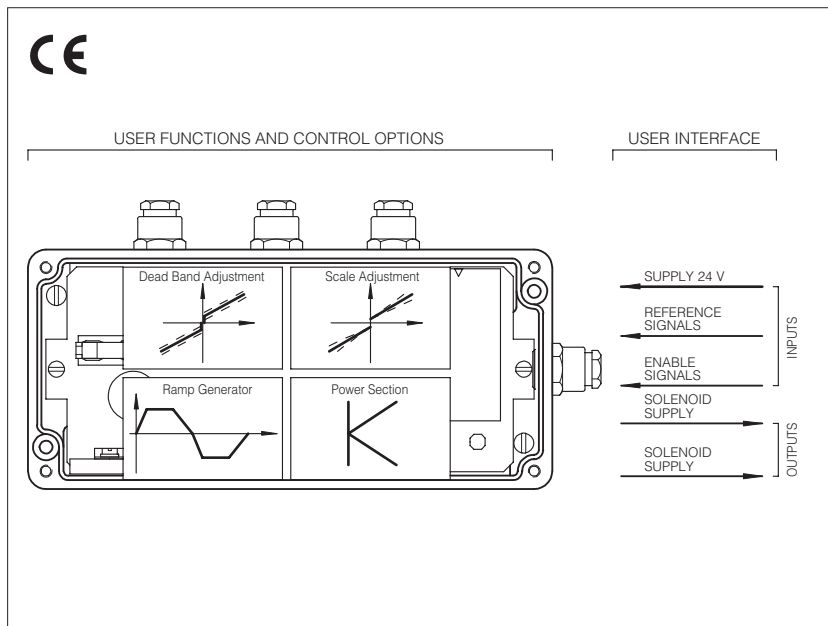

E-RP-AC

Analog drivers control the current to the solenoid of Atos proportional valves without pressure or position transducer, regulating the spool position, the flow or the pressure according to the electronic reference signal.

Features:

- bias and scale regulations by potentiometers
- symmetrical (standard) or dissymmetrical (/RR option) rising and falling ramp generator
- factory pre-set
- aluminium box with IP65 protection degree
- power supply 24 VDC or 12 VDC (/12 option)
- electronic filters on input and output lines
- CE marking according to EMC directive

Applications:

Pressure, flow, position open or closed-loop regulation systems, according to the block diagram [2].

1 MODEL CODE

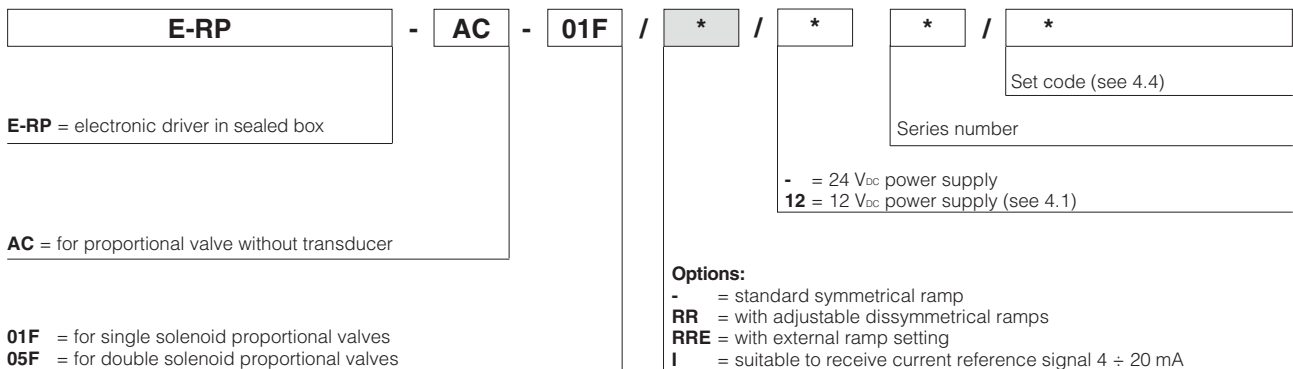

2 BLOCK DIAGRAM

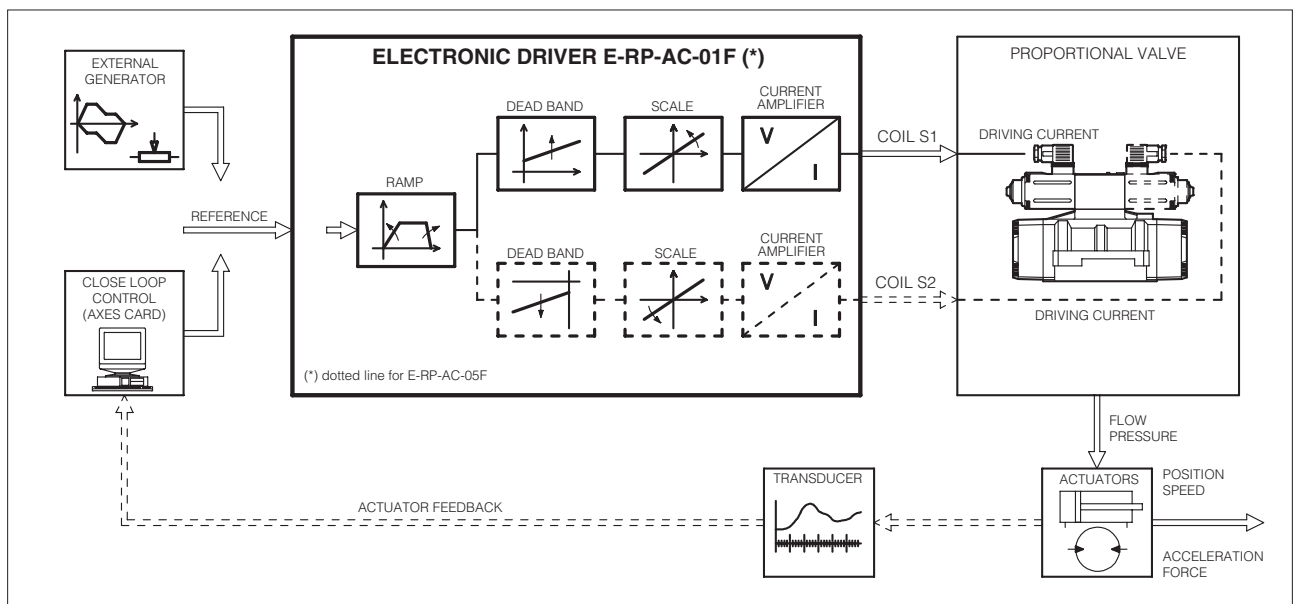

3 MAIN CHARACTERISTICS

Power supply (see 4.1)	Nominal: +24 V _{DC} Nominal: +12 V _{DC}	Rectified and filtered: V _{RMS} = 21 ÷ 33 V _{MAX} (ripple max 10 % V _{PP}) Rectified and filtered: V _{RMS} = 10 ÷ 14 V _{MAX} (ripple max 10 % V _{PP})
Max power consumption	50 W	
Current supplied to solenoids	I _{MAX} = 3.3 A square wave PWM type; (for ex-proof valves I _{MAX} = 2,5 A)	
Nominal reference signal, factory preset	E-RP-AC-01F: E-RP-AC-05F: 4 ÷ 20 mA for I/:	0 ÷ 5 V at contact 10 (GND on 11) ±5 V at contact 10 (GND on 11) at contacts 10 (+) and 11 (-)
Reference signal variation range (Scale adjust)	±10 V _{MAX} ±2,5 V _{MIN}	
Input signal impedance	Voltage signal R _i > 50 kΩ - (I/ option R _i = 316 Ω)	
Potentiometers supply	+5 V / 50 mA at contact 8 and -5 V / 20 mA at contact 9	
Ramp time	5 or 90 sec. max (0 ÷ 100 % of reference signal) see [8]	
Enabling signal	V = 5 ÷ 24 V _{DC} on contact 7	
Electrical wiring	Coil : 2 x 1 mm ² to 20 m 2 x 1,5 mm ² shielded to 40 m	
Card format	Sealed box IP65	
Connections	14 contacts - terminal strip	
Cable Clamp	Dimension PG7 - water proof - Cable Ø 5 ÷ 6,5	
Operating temperature	0 ÷ +50 °C (storage -20° ÷ +70 °C)	
Box dimensions	175 x 80 x 57 mm	
Mass	940 g	
Features	Rapid solenoid excitation and switching off Outputs to solenoids protected against accidental short circuits	

4 GENERAL SPECIFICATIONS

4.1 Power supply and wirings

The power supply must be appropriately stabilized or rectified and filtered. If the power supply is generated by a single phase rectifier, use a 10000µF/40V capacitor; if pulse voltage is generated by a three phase rectifier connect a 4700µF/40V capacitor (see table [11]).

Connect the reference signal to the main electronic control by means of shielded and twisted cables. Pay attention: the negative and the positive poles must not be exchanged each other. Shield the wirings to avoid electromagnetic noise (EMC).

It is suitable to keep the driver and its cables far from any electromagnetic radiation source (like cables where high currents flow, electric motors, transformers, relays, solenoids, portable radio-transmitter, etc.). Wire the earth connection as shown in [11], according to CEI EN 60204-1 standards.

Connect the shield of the driver to the noiseless earth terminal (TE) [13].

The driver is designed to correctly work with 24 V_{DC} (±20%) or 12 V_{DC} (±20%) nominal voltage supply coupled with coils having a resistance from 2,0 Ω to 13,4 Ω, as shown in the side table.

Nominal supply	Valve code	R at 20 °C [Ω]
24 V _{DC}	*ZMO, *ZGO, *ZO(R)-A-* (1)	3,2
	*ZMA, *ZGA, *ZO(R)-A-* (1)	3,2
	*ZMO, *ZGO, *ZO(R)-A-*1/8	13,4
12 V _{DC}	*ZMO, *ZGO, *ZO(R)-A-*1/6	2,1

(1) Standard coupling

The driver is protected against overloads by an internal safety fuse: 4 A fast fuse (see [9]).

4.2 Reference signal

The electronic driver is designed to receive voltage or current reference signals, see table [5]. Note that drivers suitable to receive current reference (I/ option) have signal values in the range 4 to 20mA.

It is possible to use current option also for double channels drivers type E-RP-AC-05F using the reference inversion signal on contact 12.

4.3 Monitor signal

This voltage output signal allows to measure the current supplied to the coil, read by a voltmeter between the test points on the card (see [9]).

Reading scale is 1 mV = 1 mA. To visualize the signals use voltmeters with impedance >10 KΩ.

4.4 Set code

Basic calibration of the electronic driver is factory pre-set according to proportional valve it has to be coupled with. These pre-calibrations are identified by a standard number in the model code as follows:

1 = RZGO, KZGO 2 = RZMO, AG*ZO, LI*ZO
3 = DHZO, DKZOR 4 = DPZO-A-*5, DPZO-A-*7
6 = QV*ZO(R), LIQZO

For ex-proof valves, insert an "A" before the code of adjustment.

For example, the code of adjustment for RZGA is A1 (see tech table E120).

4.5 Calibrations accessible to the user, see [8], [9].

Scale

The relation between driving current and reference signal can be regulated with the Scale adjustment. For single solenoid valves with two external operating positions, the reference signal is the same as the double solenoid driver. Separate Scale potentiometer for solenoid S1 and S2 enable the electronic driver to be set for different output currents, obtaining differential hydraulic operations.

Bias (dead band)

Regulation of dead band adjusts the hydraulic zero of the valve (adjustment of starting position) to the corresponding electrical zero. The electronic driver is factory preset for the valve it is coupled according to the set code (see section 4.4). For double solenoid driver E-RP-AC-05F/* a step function generator becomes active at an input reference voltage signal greater than ± 100 mV enabling start current set by Bias potentiometers S1 and S2 for independent solenoid Dead Band regulation.

5 EXTERNAL REFERENCE SIGNALS

EXTERNAL POTENTIOMETERS CONNECTIONS

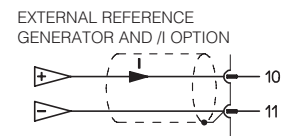
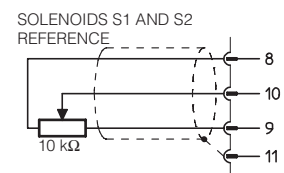
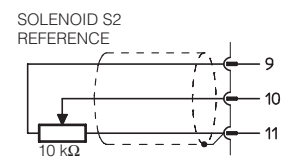
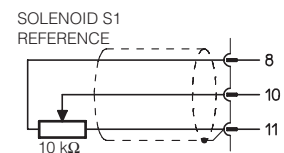

6 EXTERNAL RAMPS - /RRE option

EXAMPLE WITH THREE EXTERNAL RAMPS

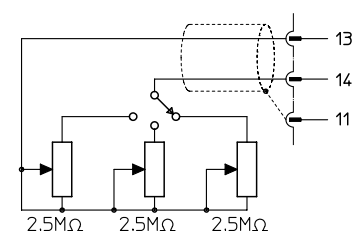

Ramps, see [6], [8], [9].

The internal ramp generator circuit converts a step input signal into a slowly increasing output signal (solenoid current).

The rise/fall time of the current is set via potentiometer P1, to a maximum time of 5 or 90 sec (switch SW1) for 0 - 100% of reference signal. The /RR option provides dissymmetrical ramps, (P2) /RRE option allows external ramp setting as shown in table [6].

To switch off the ramp circuit connect contacts 13 and 14 on the electric connector.

7 INSTALLATION AND START-UP

It is advisable to perform calibration procedures in the order given below.

7.1 Warning

- Never insert or remove the driver connector while the electronic system is powered on.
- Voltages must always be measured with reference to GND (connector contact 11) or test point.
- Refer to [9] to identify components mentioned in calibration procedures.

7.2 Start-up

Factory preset adjustments may not meet the desired requirements for the specific application and performances can be optimized by on-site re-adjustments of bias, scale and ramps potentiometers, in sequence.

- Connect the electronic driver according to the desired connection diagram (see [11], [12]).
- The current supplied to the coil can be measured by a voltmeter connected between test point (current monitor and GND).

For E-RP-AC-05F the drive enabled led (S1 or S2) shows the supplied coil.

Enabling signal, see [11], [12].

The electronic driver operate when the contact 7 is supplied with an enabling signal (usually 24 V_{cc}). It could be useful in emergency conditions to inhibit the driver by zeroing this signal.

Bias adjustment (Dead band compensation), see [8], [9].

- Supply a reference signal voltage (0V_{cc} for E-RP-AC-01F and ±0,1 V_{cc} for E-RP-AC-05F).
- Gradually turn bias potentiometer(s) until a movement of the controlled actuator is obtained.
- Turn in the opposite direction, until the actuator is stopped.

Scale adjustment see [8], [9].

Supply max reference signal voltage (for E-RP-AC-05F driver repeat for max negative voltage) in the specified range and turn scale potentiometer(s) until the actuator speed reaches the desired value.

Ramps (see [8], [9]).

- Turning ramp potentiometer(s) clockwise acceleration(s) and deceleration(s) can be reduced to obtain optimization of the complete system.

8 RAMP AND SETTINGS

E-RP-AC-01F ADJUSTMENT

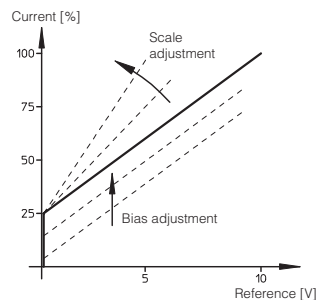

E-RP-AC-05F ADJUSTMENT

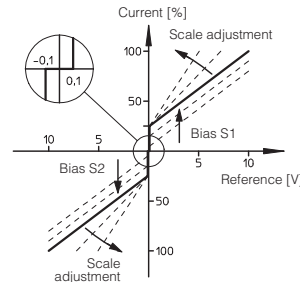

/RR OPTION - UP AND DOWN RAMP

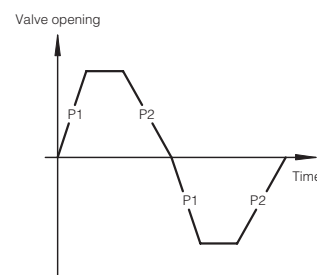

9 E-RP-AC-05F TOPOGRAPHICAL VIEW OF REGULATIONS AND DIMENSIONS [mm]

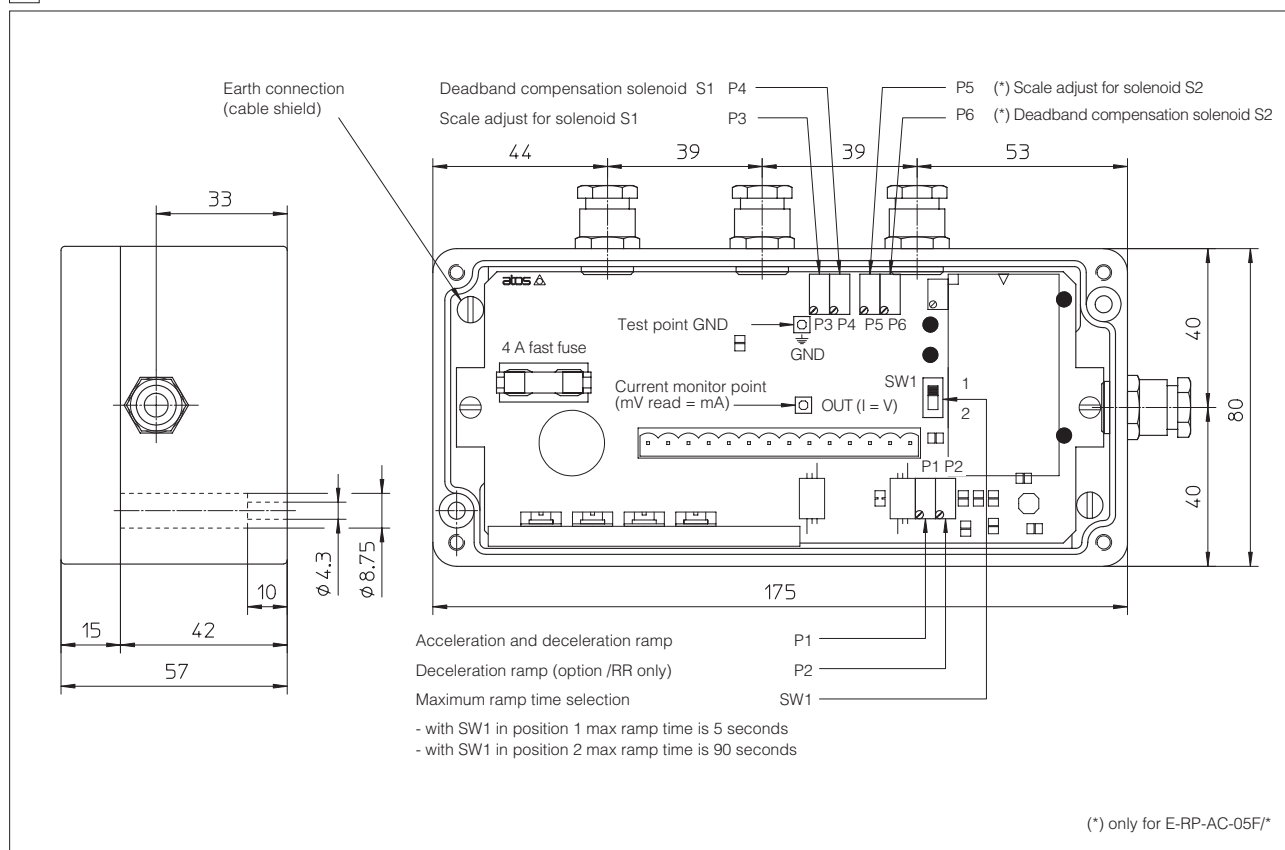

10 IMPORTANT INSTRUCTIONS

ELETTROMAGNETIC COMPATIBILITY

Atos electronic drivers and proportional valves are designed according to the 2004/108/CE Directive (Electromagnetic Compatibility) and according to EN 50081-2 (Emission) and EN 50082-2 (Immunity) standards. The electromagnetic compatibility of electronic drivers is valid only for wirings realized according to the typical electric connections shown in this technical table.

The device must be verified on the machine because the magnetic field may be different from the test conditions.

SAFETY

The electrical signals (for example reference signals, feedback and enable signal) of electronic drivers must not be used to realize safety conditions of the machine. This is in accordance with the provisions of European directives (Safety requirements of fluid technology systems and components-hydraulics, EN 982). Special attention must be paid to switch-on/switch-off of electronic drivers because they could produce uncontrolled movements of actuators operated by the proportional valves.

11 WIRING BLOCK DIAGRAM

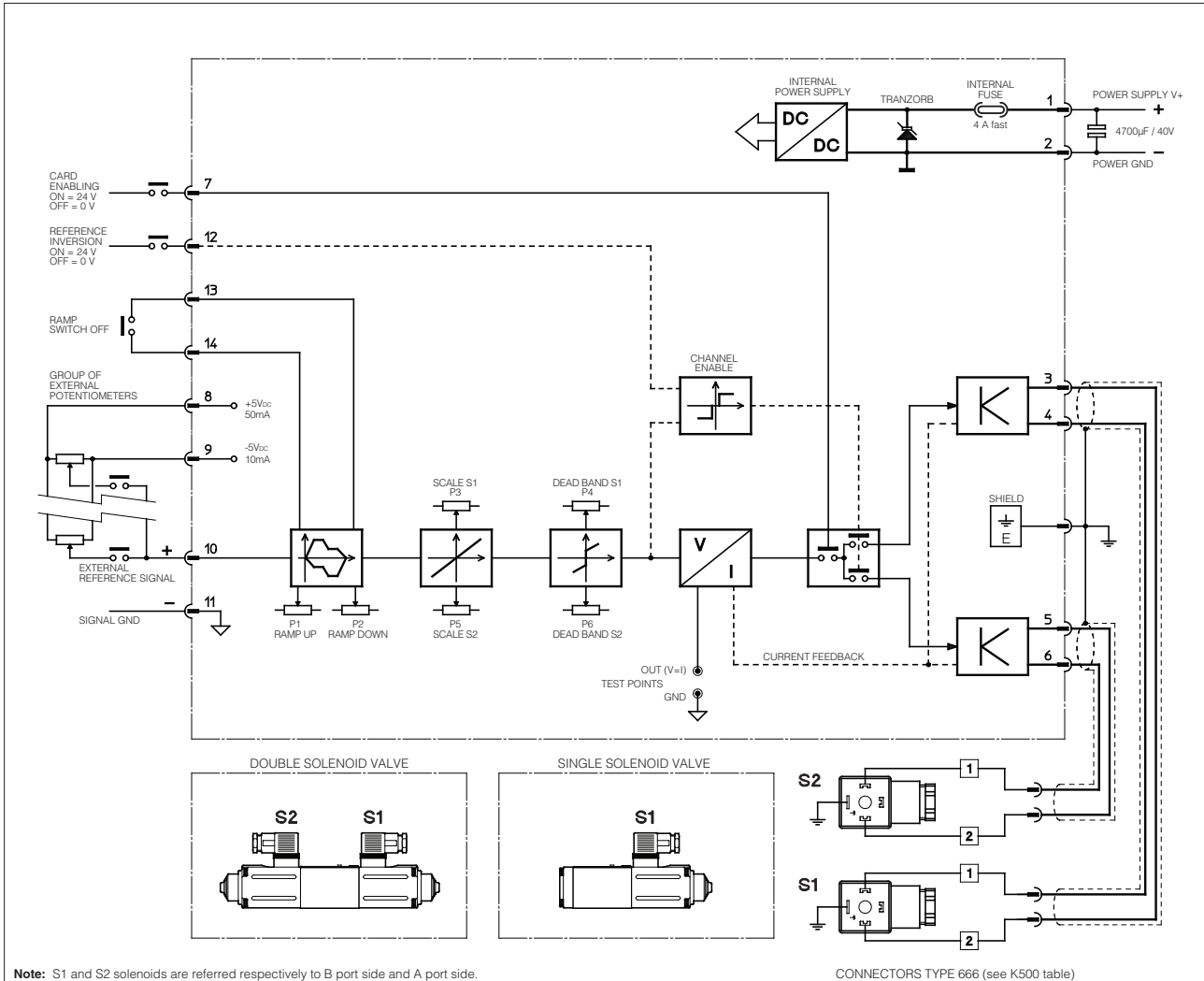

12 GENERAL CONNECTIONS

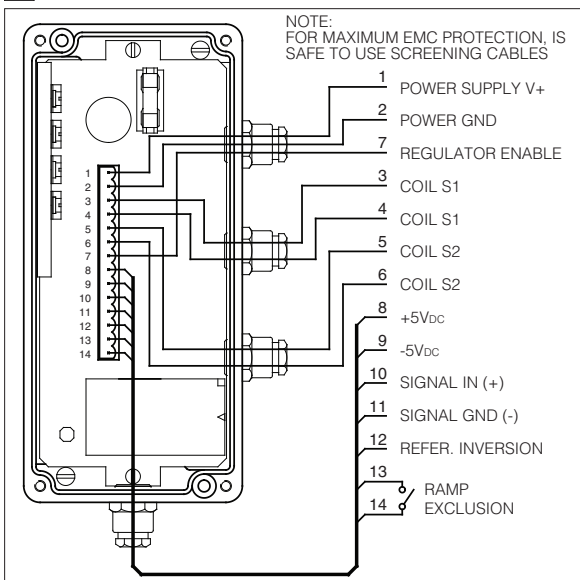

13 EARTH CONNECTIONS

