

Digital electronic TES/LES drivers

integral-to-valve format, for proportional valves with one or two spool position transducers

DLKZOR- TES -SN-

| | |
|-----------|-------------|
| NP | Not Present |
| BC | CANopen |
| BP | PROFIBUS DP |
| EH | EtherCAT |
| EW | POWERLINK |
| EI | EtherNet/IP |

DPZO- LES -SN-

| | |
|-----------|-------------|
| NP | Not Present |
| BC | CANopen |
| BP | PROFIBUS DP |
| EH | EtherCAT |
| EW | POWERLINK |
| EI | EtherNet/IP |

Scale

Bias

Linearization

Ramps

Real Time
Fieldbus
Reference

Enhanced
Diagnostic

USB
port

Digital Electrohydraulic - Dimensione aggr.
 Programming Software
 E-SW-FIELDBUS

E-SW
programming software

Connectors and cables ④, ⑤ and ⑥ not included, to be ordered separately

TES, LES

Digital drivers ① supply and control, in closed loop, the position of the spool or poppet of direct and pilot operated proportional valves according to the electronic reference input signal.

TES execution operates direct operated directional/flow control valves with one integral spool position transducer ②.

LES execution operates pilot operated directional valves with two integral spool position transducers ② and ③.

Atos PC software allows to customize the driver configuration to the specific application requirements.

Electrical features:

- Functional parameters are factory preset for best performances
- 7 pin main connector ④ for power supply, analog input reference and monitor signals
- 5 pin USB connector ⑤ always present
- 3 leds for diagnostic (see 3.1)
- IN / OUT fieldbus communication connectors ⑥ (see section [5])
- /Q option 7 pin main connector for enable signal
- /F option 7 pin main connector for fault signal
- /Z option 12 pin main connector for additional double power supply, enable and fault signals
- Electrical protection against reverse polarity of power supply
- Operating temperature range: -40° ÷ +60°
- IP66 / IP67 protection degree
- Rugged construction
- CE mark according to EMC directive
- Available S option for additional alternated pressure or force control see tech table GS212

Software Features:

- Intuitive graphic interface
- Setting of valve's functional parameters: bias, scale, ramps, dither
- Linearization function for the hydraulic regulation
- Setting of PID gains
- Selection of analog IN / OUT range
- Complete diagnostics of driver status
- Internal oscilloscope function
- In field firmware update through USB port

1 VALVES RANGE

| Valves model | Directional | | | Flow | Directional | Cartridge |
|--------------|---------------|-----------------|-------|-----------------|--------------|----------------|
| | DHZO DKZOR | DLHZO DLKZOR | DPZO | QVHZO QVKZOR | DPZO | LIQZO LIQZP |
| Data sheet | FS165, FS168 | FS180 | FS172 | FS412 | FS175, FS178 | FS330, FS340 |
| Driver model | TES | | | | LES | |

2 MAIN CHARACTERISTICS

| | |
|--------------------------------------|---|
| Power supplies (see 4.1, 4.4) | Nominal : +24 Vdc Rectified and filtered : $V_{RMS} = 20 \div 32 V_{MAX}$ (ripple max 10 % V_{PP}) |
| Max power consumption | 50 W |
| Reference input signals (see 4.2) | Voltage: range ± 10 Vdc (24 V_{MAX} tollerant) Input impedance: $R_i > 50$ k Ω Current: range ± 20 mA Input impedance: $R_i = 500$ Ω |
| Monitor outputs (see 4.3) | Output range: voltage ± 10 Vdc @ max 5 mA current ± 20 mA @ max 500 Ω load resistance |
| Enable input (see 4.5) | Range: $0 \div 5$ Vdc (OFF state), $9 \div 24$ Vdc (ON state), $5 \div 9$ Vdc (not accepted); Input impedance: $R_i > 10$ k Ω |
| Fault output (see 4.6) | Output range: $0 \div 24$ Vdc (ON state $> [power\ supply - 2\ V]$; OFF state $< 1\ V$) @ max 50 mA; external negative voltage not allowed (e.g. due to inductive loads) |
| Alarms | Solenoid not connected/short circuit, cable break with current reference signal, over/under temperature, valve spool transducer malfunctions |
| Format | Sealed box on the valve; IP66 / IP67 protection degree with mating connectors |
| Tropicalization | Tropical coating on electronics PCB |
| Operating temperature | $-40 \div +60$ °C (storage $-40 \div +70$ °C) |
| Mass | Approx. 490 g |
| Additional characteristics | Short circuit protection of solenoid's current supply; 3 leds for diagnostic; spool position control by P.I.D. with rapid solenoid switching; protection against reverse polarity of power supply |
| Electromagnetic compatibility (EMC) | According to Directive 2014/30/UE (Immunity: EN 61000-2; Emission: EN 61000-3) |
| Communication interface | USB Atos ASCII coding CANopen EN50325-4 + DS408 PROFIBUS DP EN50170-2/IEC61158 EtherCAT, POWERLINK, EtherNet/IP IEC 61158 |
| Communication physical layer | not insulated USB 2.0 + USB OTG optical insulated CAN ISO11898 optical insulated RS485 Fast Ethernet, insulated 100 Base TX |
| Recommended wiring cable (see [9]) | LiYCY shielded cables |

Note: a minimum booting time between 400 and 800 ms has be considered from the driver energizing with the 24 Vdc power supply before the valve has been ready to operate. During this time the current to the valve coils is switched to zero

3 CONNECTIONS AND LEDS

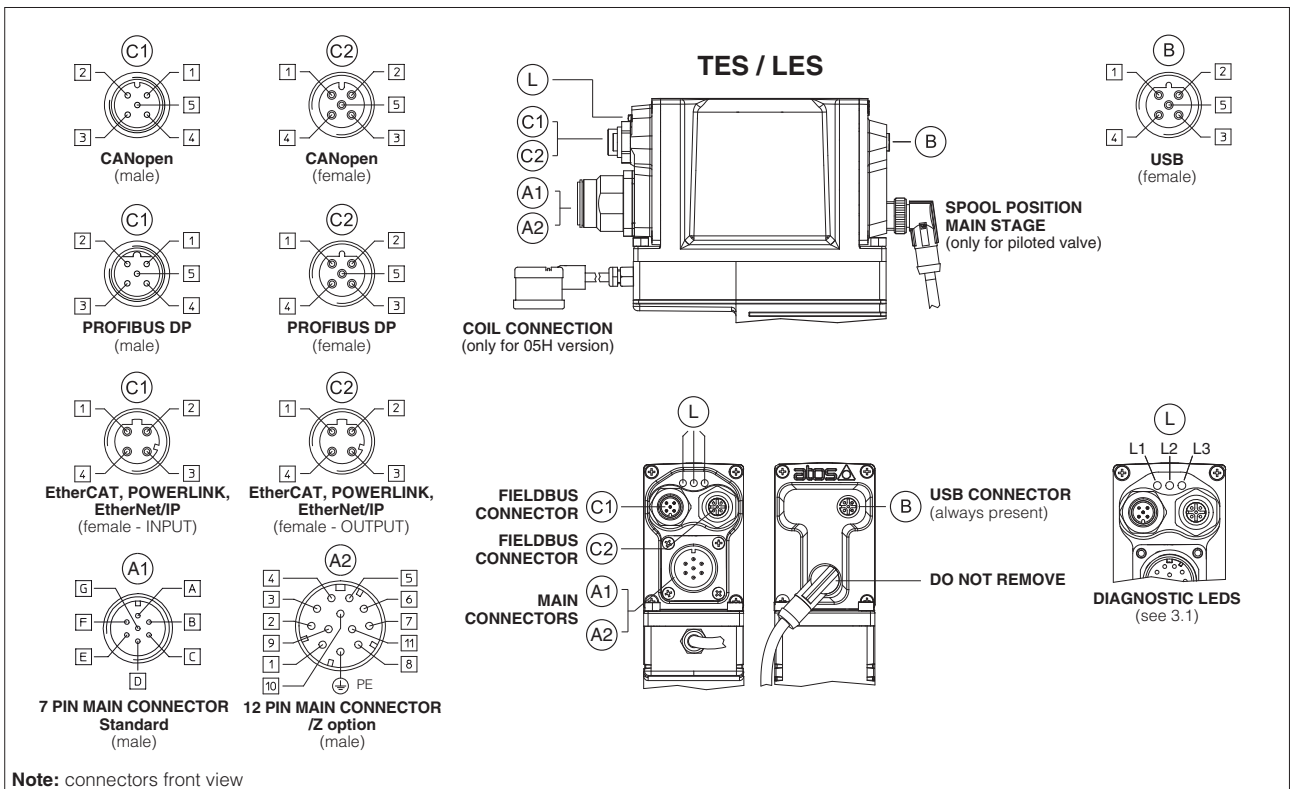

3.1 Diagnostic LEDs (L)

Three leds show driver operative conditions for immediate basic diagnostics. Please refer to the driver user manual for detailed information.

| FIELDBUS LEDS | NP Not Present | BC CANopen | BP PROFIBUS DP | EH EtherCAT | EW POWERLINK | EI EtherNet/IP | L1 L2 L3 |
|---------------|----------------|-----------------|----------------|-------------|----------------|----------------|----------|
| L1 | | VALVE STATUS | | | LINK/ACT | | |
| L2 | | NETWORK STATUS | | | NETWORK STATUS | | |
| L3 | | SOLENOID STATUS | | | LINK/ACT | | |

3.2 Main connector signals - 7 pin - standard, /Q and /F options (A1) - see 9.1

| PIN | Standard | /Q | /F | TECHNICAL SPECIFICATIONS | NOTES |
|-----|-------------------------------------|--------|-------|---|--|
| A | V+ | | | Power supply 24 Vdc (see 4.1) | Input - power supply |
| B | V0 | | | Power supply 0 Vdc (see 4.1) | Gnd - power supply |
| C | AGND | | AGND | Analog ground | Gnd - analog signal |
| | | ENABLE | | Enable (24 Vdc) or disable (0 Vdc) the driver, referred to V0 (see 4.4) | Input - on/off signal |
| D | Q_INPUT+ | | | Flow reference input signal: ± 10 Vdc / ± 20 mA maximum range (see 4.2) | Input - analog signal Software selectable |
| E | INPUT- | | | Negative reference input signal for Q_INPUT+ | Input - analog signal |
| F | Q_MONITOR referred to: AGND V0 | | | Flow monitor output signal: ± 10 Vdc / ± 20 mA maximum range (see 4.3) | Output - analog signal Software selectable |
| | | | FAULT | Fault (0 Vdc) or normal working (24 Vdc), referred to V0 (see 4.6) | Output - on/off signal |
| G | EARTH | | | Internally connected to driver housing | |

3.3 Main connector signals - 12 pin - /Z option (A2) - see 9.2

| PIN | /Z | TECHNICAL SPECIFICATIONS | NOTES |
|-----|-----------|---|--|
| 1 | V+ | Power supply 24 Vdc (see 4.1) | Input - power supply |
| 2 | V0 | Power supply 0 Vdc (see 4.1) | Gnd - power supply |
| 3 | ENABLE | Enable (24 Vdc) or disable (0 Vdc) the driver, referred to VLO (see 4.4) | Input - on/off signal |
| 4 | Q_INPUT+ | Flow reference input signal: ± 10 Vdc / ± 20 mA maximum range (see 4.2) | Input - analog signal Software selectable |
| 5 | INPUT- | Negative reference input signal for Q_INPUT+ | Input - analog signal |
| 6 | Q_MONITOR | Flow monitor output signal: ± 10 Vdc / ± 20 mA maximum range, referred to VLO (see 4.3) | Output - analog signal Software selectable |
| 7 | NC | Do not connect | |
| 8 | NC | Do not connect | |
| 9 | VL+ | Power supply 24 Vdc for driver's logic and communication (see 4.4) | Input - power supply |
| 10 | VLO (1) | Power supply 0 Vdc for driver's logic and communication (see 4.4) | Gnd - power supply |
| 11 | FAULT | Fault (0 Vdc) or normal working (24 Vdc), referred to VLO (see 4.6) | Output - on/off signal |
| PE | EARTH | Internally connected to driver housing | |

Note: (1) do not disconnect VLO before VL+ when the driver is connected to PC USB port

3.4 Communication connectors (B) - (C) - see 9.3

| (B) USB connector - M12 - 5 pin always present | | |
|--|---------|-----------------------------|
| PIN | SIGNAL | TECHNICAL SPECIFICATION (1) |
| 1 | +5V_USB | Power supply |
| 2 | ID | Identification |
| 3 | GND_USB | Signal zero data line |
| 4 | D- | Data line - |
| 5 | D+ | Data line + |

| (C1) (C2) BC fieldbus execution, connector - M12 - 5 pin | | |
|--|----------|---|
| PIN | SIGNAL | TECHNICAL SPECIFICATION (1) |
| 1 | CAN_SHLD | Shield |
| 2 | not used | (C1) - (C2) pass-through connection (2) |
| 3 | CAN_GND | Signal zero data line |
| 4 | CAN_H | Bus line (high) |
| 5 | CAN_L | Bus line (low) |

| (C1) (C2) BP fieldbus execution, connector - M12 - 5 pin | | |
|--|--------|---------------------------------------|
| PIN | SIGNAL | TECHNICAL SPECIFICATION (1) |
| 1 | +5V | Termination supply signal |
| 2 | LINE-A | Bus line (high) |
| 3 | DGND | Data line and termination signal zero |
| 4 | LINE-B | Bus line (low) |
| 5 | SHIELD | |

| (C1) (C2) EH, EW, EI fieldbus execution, connector - M12 - 4 pin | | |
|--|--------|-----------------------------|
| PIN | SIGNAL | TECHNICAL SPECIFICATION (1) |
| 1 | TX+ | Transmitter |
| 2 | RX+ | Receiver |
| 3 | TX- | Transmitter |
| 4 | RX- | Receiver |
| Housing | SHIELD | |

Notes: (1) shield connection on connector's housing is recommended

(2): pin 2 can be fed with external +5V supply of CAN interface

4 SIGNALS SPECIFICATIONS

Atos digital drivers are CE marked according to the applicable directives (e.g. Immunity/Emission EMC Directive). Installation, wirings and start-up procedures must be performed according to the general prescriptions shown in tech table **F003** and in the user manuals included in the E-SW programming software.

The electrical signals of the valve (e.g. monitor signals) must not be directly used to activate safety functions, like to switch-ON/OFF the machine's safety components, as prescribed by the European standards (Safety requirements of fluid technology systems and components-hydraulics, EN-982).

4.1 Power supply (V+ and V0)

The power supply must be appropriately stabilized or rectified: apply at least a 10000 μ F/40 V capacitance to single phase rectifiers or a 4700 μ F/40 V capacitance to three phase rectifiers.

In case of double power supply see 4.4.

A safety fuse is required in series to each power supply: 2,5 A time lag fuse.

4.2 Reference input signal (Q_INPUT+)

The driver controls in closed loop the valve spool position proportionally to the external reference input signal.

Reference input signal is factory preset according to selected valve code, defaults are ± 10 Vdc for standard and $4 \div 20$ mA for /I option.

Input signal can be reconfigured via software selecting between voltage and current, within a maximum range of ± 10 Vdc or ± 20 mA.

Drivers with fieldbus interface can be software set to receive reference signal directly from the machine control unit (fieldbus reference). Analog reference input signal can be used as on-off commands with input range $0 \div 24$ Vdc.

4.3 Monitor output signal (Q_MONITOR)

The driver generates an analog output signal proportional to the actual spool position of the valve; the monitor output signal can be software set to show other signals available in the driver (e.g. analog reference, fieldbus reference, pilot spool position).

Monitor output signal is factory preset according to selected valve code, defaults are ± 10 Vdc for standard and $4 \div 20$ mA for /I option.

Output signal can be reconfigured via software selecting between voltage and current, within a maximum range of ± 10 Vdc or ± 20 mA.

4.4 Power supply for driver's logic and communication (VL+ and VL0) - only for /Z option

The power supply for driver's logic and communication must be appropriately stabilized or rectified and filtered: apply at least a 10000 μ F/40 V capacitance to single phase rectifiers or a 4700 μ F/40 V capacitance to three phase rectifiers.

The separate power supply for driver's logic on pin 9 and 10, allow to remove solenoid power supply from pin 1 and 2 maintaining active the diagnostics, USB and fieldbus communications.

A safety fuse is required in series to each driver's logic and communication power supply: 500 mA fast fuse.

4.5 Enable input signal (ENABLE) - only for /Q and /Z options

To enable the driver, supply a 24 Vdc on pin 3 (pin C): Enable input signal allows to enable/disable the current supply to the solenoid, without removing the electrical power supply to the driver; it is used to active the communication and the other driver functions when the valve must be disabled for safety reasons. This condition does not comply with European Norms EN13849-1 (ex EN954-1).

Enable input signal can be used as digital input by software selection.

4.6 Fault output signal (FAULT) - only for /F and /Z options

Fault output signal indicates fault conditions of the driver (solenoid short circuits/not connected, reference signal cable broken for $4 \div 20$ mA input, spool position transducer cable broken, etc.). Fault presence corresponds to 0 Vdc, normal working corresponds to 24 Vdc.

Fault status is not affected by the Enable input signal. Fault output signal can be used as digital output by software selection.

5 IN / OUT FIELDBUS COMMUNICATION CONNECTORS

Two fieldbus communication connectors are always available for digital drivers executions BC, BP, EH, EW, EI. This features allows considerable technical advantages in terms of installation simplicity, wirings reduction and also avoid the usage expensive T-connectors.

For BC and BP executions the fieldbus connectors have an internal pass-through connection and can be used like end point of the fieldbus network, using an external terminator (see tech table **GS500**).

For EH, EW and EI execution the external terminators are not required: each connector is internally terminated.

BC and BP pass-through connection

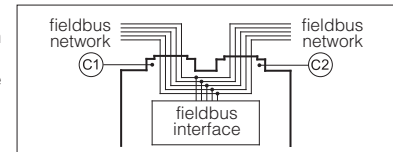

6 PROGRAMMING TOOLS - see tech table **GS500**

Valve's functional parameters and configurations, can be easily set and optimized using Atos E-SW programming software connected via USB port to the digital driver. For fieldbus versions, the software permits valve's parameterization through USB port also if the driver is connected to the central machine unit via fieldbus.

The software is available in different versions according to the driver's options:

| | | | |
|-------------------------------|--|------------------|---------------|
| E-SW-BASIC support: | NP (USB) | PS (Serial) | IR (Infrared) |
| E-SW-FIELDBUS support: | BC (CANopen) | BP (PROFIBUS DP) | EH (EtherCAT) |
| | EW (POWERLINK) | EI (EtherNet/IP) | |
| E-SW-/PQ support: | valves with SP, SF, SL alternated control (e.g. E-SW-BASIC/PQ) | | |

USB connection

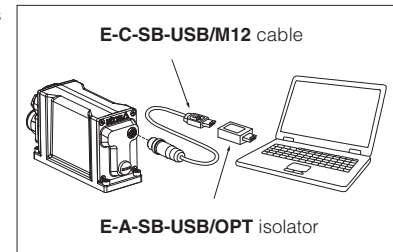

WARNING: drivers USB port is not isolated!

The use of isolator adapter is highly recommended for PC protection (see table **GS500**)

Free programming software, web download:

E-SW-BASIC web download = software can be downloaded upon web registration at www.download.atos.com ; service and DVD not included
Upon web registration user receive via email the Activation Code (software free license) and login data to access Atos Download Area

DVD programming software, to be ordered separately:

E-SW-* DVD first supply = software has to be activated via web registration at www.download.atos.com ; 1 year service included
Upon web registration user receive via email the Activation Code (software license) and login data to access Atos Download Area

E-SW-*-N DVD next supplies = only for supplies after the first; service not included, web registration not allowed
Software has to be activated with Activation Code received upon first supply web registration

Atos Download Area: direct access to latest releases of E-SW software, manuals, USB drivers and fieldbus configuration files at www.download.atos.com

USB Adapters, Cables and Terminators, can be ordered separately

7 MAIN SOFTWARE PARAMETER SETTINGS

The following is a brief description of the main settings and features of digital drivers.

For a detailed descriptions of available settings, wirings and installation procedures, please refer to the user manual included in the E-SW programming software:

E-MAN-RI-LES - user manual for **TES** and **LES**

7.1 Scale

Scale function allows to set the maximum valve opening at maximum reference signal value.

This regulation allows to reduce the maximum valve regulation in front of maximum reference signal.

Two different Scale regulations are available for double solenoid valves or three position single solenoid valves: ScaleA for positive and ScaleB for negative reference signal.

7.2 Bias and Threshold

Proportional valves may be provided with a dead band in the hydraulic regulation corresponding to their switch-off status.

This dead band discontinuity in the valve's regulation can be compensated by activating the Bias function, which adds a fixed preset Bias value to the reference signal (analog or fieldbus external input).

The Bias function is activated when the reference signal overcome the Threshold value, preset into the driver.

The Bias setting allows to calibrate the Bias valve opening to the specific proportional valve to which the driver is coupled.

The Threshold setting is useful to avoid undesired valve regulation at zero reference signal when electric noise is present on the analog input signal: smaller threshold reduces the reference signal dead band, greater values are less affected by electric noise presence.

If fieldbus reference signal is active (see 4.2), threshold should be set to zero.

Two different Bias regulations are available for double solenoid valves: positive reference signals activate BiasA and negative reference signals activate BiasB.

Refer to the programming manuals for a detailed description of other software selectable Bias functions.

7.3 Offset

Proportional valves may be provided with zero overlapping in the hydraulic regulation corresponding to zero reference input signal (valve's central spool position).

The Offset function allows to calibrate the valve's spool central position to the specific hydraulic system setup (e.g. valve applied to cylinder with differential areas). Offset default setting is zero.

7.1, 7.2 - Scale, Bias & Threshold

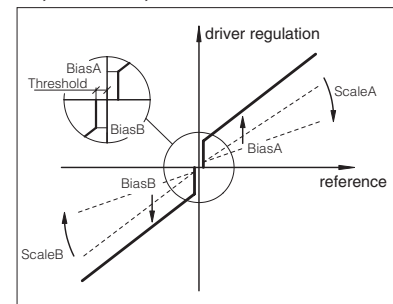

7.3 - Offset

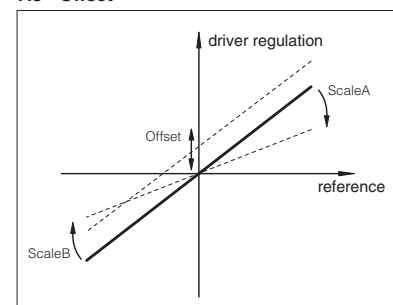

7.4 Ramps

The ramp generator allows to convert sudden change of electronic reference signal into smooth time-dependent increasing/decreasing of the valve opening.

Different ramp mode can be set:

- single ramp for any reference variation
- two ramps for increasing and for decreasing reference variations
- four ramps for positive/negative signal values and increasing/decreasing reference variations

Ramp generator is useful for application where smooth hydraulic actuation is necessary to avoid machine vibration and shocks.

If the proportional valve is driven by a closed loop driver, the ramps can lead to unstable behaviour, for these applications ramp function can be software disabled (default setting).

7.4 - Ramps

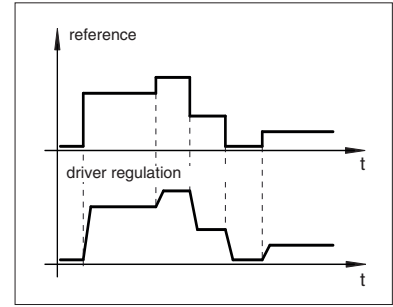

7.5 Linearization

Linearization function allows to set the relation between the reference input signal and the controlled valve's regulation.

Linearization is useful for applications where it is required to linearize the valve's regulation in a defined working condition.

7.5 - Linearization

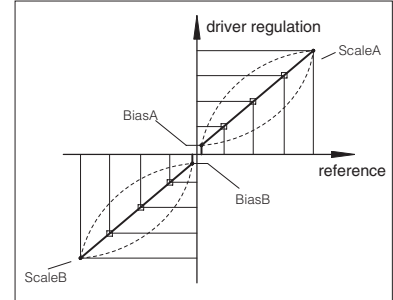

7.6 Dither

The dither is an high frequency modulation added to the valve's reference signal to reduce the hysteresis of the valve's regulation; in fact a small vibration in the valve's hydraulic regulation considerably reduces the mechanical friction effects (e.g. due to cylinder seals).

Dither frequency and amplitude are software selectable; the amplitude is automatically reduced at high reference values (high regulated flow / cylinder speed) to avoid possible instability.

Lower frequency and higher amplitude reduce hysteresis but also reduce the regulation stability. In some application this can lead to vibration and noise: right setting usually depends on system setup. Dither default setting is disabled.

8 OVERALL DIMENSIONS [mm]

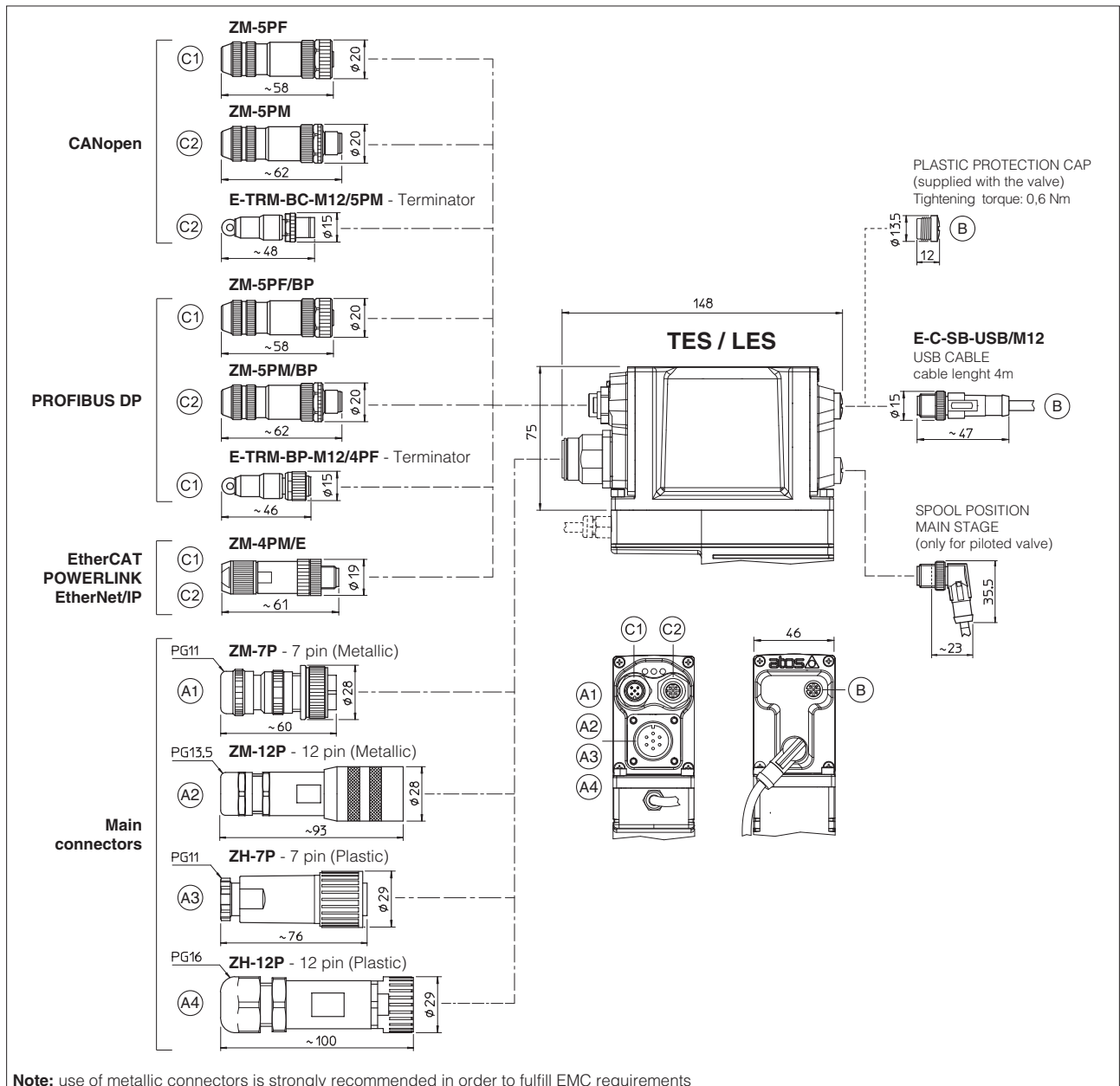

Note: use of metallic connectors is strongly recommended in order to fulfill EMC requirements

9 CONNECTORS CHARACTERISTICS - to be ordered separately

9.1 Main connectors - 7 pin

| CONNECTOR TYPE | POWER SUPPLY | POWER SUPPLY |
|-----------------------|---|---|
| CODE | (A1) ZM-7P | (A3) ZH-7P |
| Type | 7pin female straight circular | 7pin female straight circular |
| Standard | According to MIL-C-5015 | According to MIL-C-5015 |
| Material | Metallic | Plastic reinforced with fiber glass |
| Cable gland | PG11 | PG11 |
| Recommended cable | LiYCY 7 x 0,75 mm ² max 20 m (logic and power supply) or LiYCY 7 x 1 mm ² max 40 m (logic and power supply) | LiYCY 7 x 0,75 mm ² max 20 m (logic and power supply) or LiYCY 7 x 1 mm ² max 40 m (logic and power supply) |
| Conductor size | up to 1 mm ² - available for 7 wires | up to 1 mm ² - available for 7 wires |
| Connection type | to solder | to solder |
| Protection (EN 60529) | IP 67 | IP 67 |

9.2 Main connectors - 12 pin

| CONNECTOR TYPE | POWER SUPPLY | POWER SUPPLY |
|-----------------------|---|---|
| CODE | (A2) ZM-12P | (A4) ZH-12P |
| Type | 12pin female straight circular | 12pin female straight circular |
| Standard | DIN 43651 | DIN 43651 |
| Material | Metallic | Plastic reinforced with fiber glass |
| Cable gland | PG13,5 | PG16 |
| Recommended cable | LiYCY 12 x 0,75 mm ² max 20 m (logic and power supply) | LiYCY 10 x 0,14mm ² max 40 m (logic) LiYY 3 x 1mm ² max 40 m (power supply) |
| Conductor size | 0,5 mm ² to 1,5 mm ² - available for 12 wires | 0,14 mm ² to 0,5 mm ² - available for 9 wires 0,5 mm ² to 1,5 mm ² - available for 3 wires |
| Connection type | to crimp | to crimp |
| Protection (EN 60529) | IP 67 | IP 67 |

9.3 Fieldbus communication connectors

| CONNECTOR TYPE | BC CANopen (1) | | BP PROFIBUS DP (1) | | EH EtherCAT, EW POWERLINK, EI EtherNet/IP (2) | |
|-----------------------|--------------------------------------|------------------------------|--------------------------------------|------------------------------|---|--|
| CODE | (C1) ZM-5PF | (C2) ZM-5PM | (C1) ZM-5PF/BP | (C2) ZM-5PM/BP | (C1) (C2) ZM-4PM/E | |
| Type | 5 pin female straight circular | 5 pin male straight circular | 5 pin female straight circular | 5 pin male straight circular | 4 pin male straight circular | |
| Standard | M12 coding A – IEC 61076-2-101 | | M12 coding B – IEC 61076-2-101 | | M12 coding D – IEC 61076-2-101 | |
| Material | Metallic | | Metallic | | Metallic | |
| Cable gland | Pressure nut - cable diameter 6÷8 mm | | Pressure nut - cable diameter 6÷8 mm | | Pressure nut - cable diameter 4÷8 mm | |
| Cable | CANbus Standard (DR 303-1) | | PROFIBUS DP Standard | | Ethernet standard CAT-5 | |
| Connection type | screw terminal | | screw terminal | | terminal block | |
| Protection (EN 60529) | IP67 | | IP 67 | | IP 67 | |

Notes: (1) E-TRM-** terminators can be ordered separately - see tech table **GS500**

(2) Internally terminated

10 MODEL CODE FOR SPARE PARTS

Integral drivers are available as spare parts only for Atos authorized service centers.

| | | | | | | | | | | | | | | | | |
|--|---|----------|--|-----------|---|----------|---|-----------|---|------------|---|----------|---|----------|---|---------------|
| E-RI | - | T | | ES | - | N | - | NP | - | 01H | / | P | / | * | / | * |
| Integral electronic driver (1) | | | | | | | | | | | | | | | | Set code (2) |
| | | | | | | | | | | | | | | | | Series number |
| <p>T = closed-loop one LVDT transducer L = closed-loop two LVDT transducers</p> <p>ES = full</p> <p>Options, see section 3: F = fault signal Q = enable signal Z = double power supply, enable, fault and monitor signals (12 pin connector)</p> <p>P = for pilot operated proportional valves (only for TES)</p> <p>01H = for single solenoid proportional valves 05H = for double solenoid proportional valves (only for TES)</p> <p>Fieldbus interface, USB port always present: NP = Not Present EH = EtherCAT BC = CANopen EW = POWERLINK BP = PROFIBUS DP EI = EtherNet/IP</p> | | | | | | | | | | | | | | | | |

Alternated P/Q control:

N = none

S = closed loop pressure/force (see tech table **GS212**)

(1) For Ex-proof execution, please contact Atos technical department

(2) set code identifies the correspondence between the integral driver and the relevant valve; it is assigned by Atos when the driver is ordered as spare part