

DIRECT OPERATED PROPORTIONAL DIRECTIONAL VALVES

Valve model:
DHZE-TID
DKZE-TID
Driver model:
E-RI-TID-N-NP

IDENTIFICATION

Valve identification plates and label

Valve and driver name plate : L

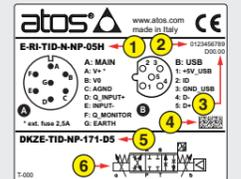
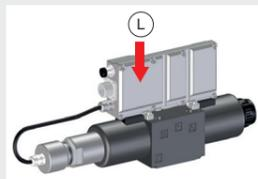

- 1 : driver code
- 2 : driver serial number
- 3 : factory firmware version
- 4 : valve matrix code
- 5 : valve code
- 6 : hydraulic symbol

INSTALLATION TOOLS ACCORDING TO VALVE MODEL- not included

Fastening bolts	Wrenches	Main connector
 socket head screws	 for fastening bolts	 7 pin - metallic
see STEP 1		see STEP 2

PROGRAMMING TOOLS - not included

PC software	mobile App	Bluetooth Adapter	OR	USB connection KIT
 E-SW-SETUP	 Atos CONNECT	 E-A-BTH		 E-C-SB-USB/M12 E-A-SB-USB/OPT

NOTE: Atos CONNECT supports Atos digital valve drivers equipped with E-A-BTH or with built-in Bluetooth, see STEP 5

PC SOFTWARE

E-SW-SETUP	supports	NP (USB)	IL (IO-Link)	PS (Serial)	IR (Infrared)
		BC (CANopen)	BP (PROFIBUS DP)	EH (EtherCAT)	
		EW (POWERLINK)	EI (EtherNet/IP)	EP (PROFINET RT/IRT)	
	supports	valves with SP, SF, SL alternated p/Q control			

REMARK Atos PC software is designed for Windows based operative systems - Windows 10 or later

PC SOFTWARE DOWNLOAD

Download PC software at www.atos.com accessing to "MyAtos -> Download area electronics"
Free registration by filling the form at www.atos.com/en-it/login
E-SW-SETUP is free and available in Download area

RELATED DOCUMENTATION - www.atos.com

FS900 Operating and maintenance information - tech. table	STARTUP BLUETOOTH Bluetooth adapter startup guide
FS155 DHZE, DKZE servoproportional - tech. table	E-MAN-RI-TID TID - driver operating manual
P005 Mounting surfaces - tech. table	
GS500 Programming tools - tech. table	
K800 Electric and electronic connectors - tech. table	

ATTENTION !

The purpose of this quickstart guide is show a logical sequence of basic operations. This guide does not cover all details or variants of Atos valves. All operations described in this document should be performed only by qualified personnel. Operations and images could be subject to change without notice. For further information please refer to related documentation.

CONTACT US

PRODUCTS OVERVIEW

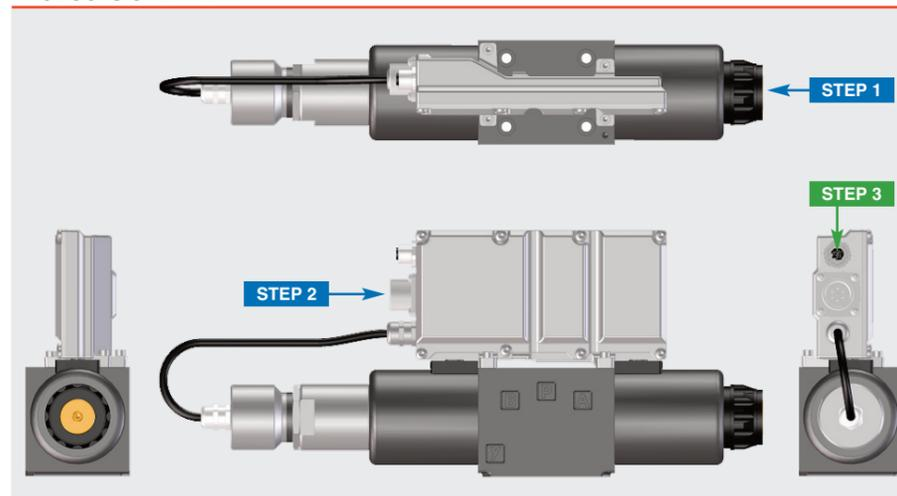

INSTALLATION		PROGRAMMING	
STEP 1	STEP 2	STEP 3	STEP 4
MECHANICAL	ELECTRICAL	PC SOFTWARE	MOBILE APP

STEP 1 MECHANICAL

In case of first commissioning, before the valve installation the whole system must be correctly flushed to grant the required cleanliness level
During the flushing operation use on-off or by-pass valves in place of the proportional valve

- remove protection pad **P1** located on the valve bottom face only immediately before installation (do not remove connectors caps)
- check the presence and correct positioning of the seals on valve ports
- verify that valve mounting surface is clean and free from damages or burrs
- verify the correct valve orientation according to the pattern of the relevant mounting interface
- lock the fastening bolts respecting below sequence and tightening torque according to valve model

DHZE-TID	DKZE-TID
<p>Mounting surface layout</p> <p>4401-03-02-0-05 n°1 OR 2025 for option /Y 4401-03-03-0-05 (for /Y without X port) n°4 OR 108 Valve size ISO 4401: 06</p> <p>Fastening bolts socket head screws Tightening torque: 8 Nm wrench 4 mm</p>	<p>Mounting surface layout</p> <p>4401-05-04-0-05 n°1 OR 108 for option /Y 4401-05-05-0-05 (for /Y without X port) n°5 OR 2050 Valve size ISO 4401: 10</p> <p>Fastening bolts socket head screws Tightening torque: 15 Nm wrench 5 mm</p>

STEP 2 ELECTRICAL

To proceed with the wiring of the main connector, perform the following steps

1 Remove main connector cap **P2**

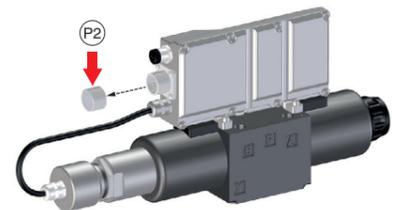

WARNING: remove power supply before any electrical or wiring operations

2 Proceed with wirings operations

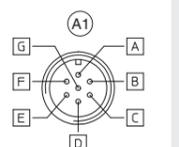

A	V+ (power supply 24Vdc)
B	V0 (power supply 0Vdc)
C	AGND
D	Q_INPUT+ (±10Vdc / 4 ± 20mA)
E	INPUT- (±10Vdc / 4 ± 20mA)
F	Q_MONITOR (±10Vdc / 4 ± 20mA)
G	EARTH

Recommended LIYCY shielded cables:
7 x 0,75 mm² max 20 m
7 x 1 mm² max 40 m

3 Connect the valve to the system

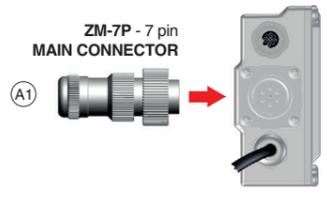

NOTE: the use of above metallic connectors is strongly recommended in order to fulfill EMC requirements

WARNING: a safety fuse is required in series to driver power supply - 2,5 A time lag fuse

ELECTRICAL WIRING EXAMPLES

MAIN CONNECTOR - REFERENCE INPUT			MAIN CONNECTOR - MONITOR OUTPUT		
REFERENCE INPUT - DIFFERENTIAL MODE			MONITOR OUTPUT		
cabinet side	main connector pin-out	valve internal circuit	cabinet side	main connector pin-out	valve internal circuit
±10 Vdc Ref. Q ⊕ Ref. Q ⊖	D E	Q_INPUT+ 50K INPUT- 50K	±10 Vdc Mon. Q ⊥ (0 V)	F C	Q_MONITOR AGND / V0
REFERENCE INPUT - COMMON MODE					
cabinet side	main connector pin-out	valve internal circuit			
±10 Vdc Ref. Q ⊥ (0 V)	D E C	Q_INPUT+ 50K INPUT- 50K AGND / V0			

STEP 3 PC SOFTWARE

REMARK proportional valves with on-board electronics are factory preset with default parameter and ready to use after piping and electrical connections. **Play with parameters is optional, not mandatory!**

3.1 CONNECTION

- 1** In order to access valve parameterization:
- Install E-SW-SETUP software on PC
 - Insert main connector to the valve and power on with 24Vdc

- 2** Remove USB plastic protection cap **P3** and connect valve to the PC as show below via Bluetooth (adapter only) or USB (cable and isolator adapter)

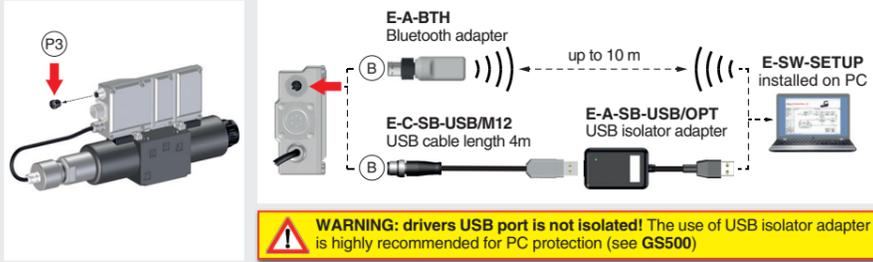

- 3** Launch the PC software using E-SW-SETUP icon:
- **PC software does NOT detect valid connection** communication is not established, please follow wizard procedure **4**
 - **PC software detects valid connection** communication automatically established - valve is **ON-LINE** see **5**



- 4** In **ON-LINE - Wizard** press button:
- a**: **WIRELESS CONNECTION**
Wizard procedure for connection via Bluetooth
 - b**: **CABLE CONNECTION**
Wizard procedure for connection via USB cable

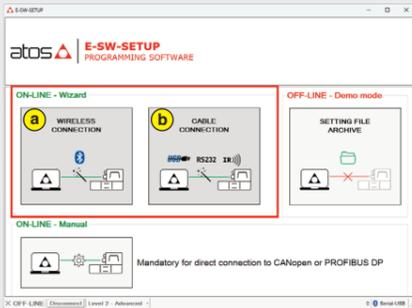

NOTE: for more info about E-A-BTH Bluetooth adapter, please refer to STARTUP BLUETOOTH guide

- 5** Communication established, valve is **ON-LINE** and it is possible change parameters

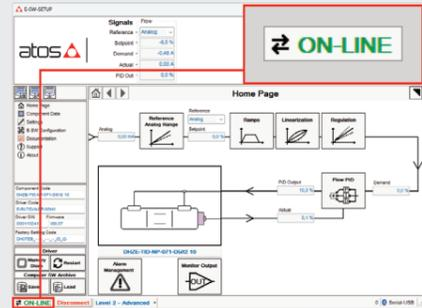

REMARK: once removed the E-A-BTH Bluetooth adapter or E-C-SB-USB/M12 USB cable, screw the plastic protection cap **P3** applying the correct tightening torque, in order to preserve valve's IP protection characteristics

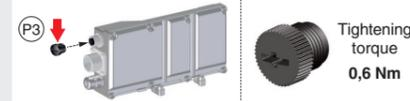

3.2 CONFIGURATION

Single solenoid directional control valve, 2 positions with positive overlapping and flow control valve

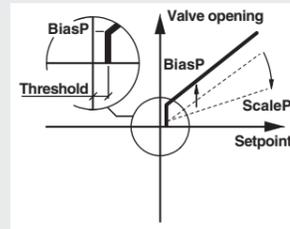

BiasP positive bias
ScaleP positive scale

Threshold = 2%
(200mV or 0,32mA for /I option)

Double solenoid directional control valve, 3 positions with positive overlapping

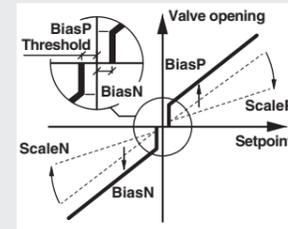

BiasP positive bias
ScaleP positive scale
BiasN negative bias
ScaleN negative scale

Threshold = 2%
(±200mV or ±0,16mA for /I option)

BIAS AND SCALE - 2 POSITION VALVES and FLOW CONTROL VALVES

- Bias setting:** supply input signal just over the Threshold value; increase the Bias until the actuator is start moving, then lightly reduce the Bias just to stop the actuator
- Scale setting:** supply the max input signal; adjust the Scale to obtain the max actuator speed

BIAS AND SCALE - 3 POSITION VALVES

Follow the same indications reported for 2 position valves and flow controls valves for both valve's solenoids

RAMPS

Ramps setting: select the required ramp configuration and adjust the ramp time to optimize the actuator's acceleration and deceleration

- No Ramp** : no ramps selected
- Single Ramp** : setup **Ramp 1**
- Double Ramp** : setup **Ramp 1 and 2**
- Four Ramps** : setup **Ramp 1, 2, 3 and 4** (only 3 position)

3.3 STORE

Parameters modifications will be stored into driver permanent memory:

- press **Memory Store** button to access **Driver - Memory Save** window
- press **Save User Set** button to store **Valve Parameters**

WARNING: during valve parameters storing operations, the driver automatically shuts down the solenoid power supply for a short time. Do not perform any storing commands while the system is working.

3.4 BACK UP

Parameter modifications will be saved into PC memory:

- press **Save** button to access **Computer SW Archive - Setting Files** page, **Setting File Name** pop-up appears
- input a valid name into **Description** field and press **Ok** button

STEP 4 MOBILE APP



ATOS CONNECT for smartphones and tablets is a free downloadable app which allows quick access to valve main functional parameters and configuration via Bluetooth, thus avoiding physical cable connection and significantly reducing commissioning times.

ATOS CONNECT app requirements:

- iOS 14 / Android 9
- Bluetooth Low Energy (BLE), version 4.0 or higher
- Atos digital valves/drivers equipped with E-A-BTH Bluetooth adapter or with built-in Bluetooth



TROUBLESHOOTING

The valve does not follow the reference signal

- valve is powered off, verify presence of 24 Vdc power supply
- flow/pressure values exceeding the valve's performance limits, verify that hydraulic operating conditions are in compliance with the valve's characteristics
- spool sticking, contact Atos service center

PC software parameters modifications are lost when valve is switched off

- parameter store operation was not performed, check store procedure – see STEP 3, section 3.3

PC software parameters modifications have no effect on the valve

- valve is OFF LINE, check connection procedure – see STEP 3, section 3.1

After the modifications of PC software parameters the valve does not work properly

- restore valve factory parameters using 'Load Factory Set' button, located in 'Driver - Memory Save' window:
 - during restore, the current to the solenoid(s) will be temporarily switched to off!
 - factory parameters will be applied at next driver restart or after power off-on sequence!