

Induction heaters for oleohydraulic fluids

Designed for rapid and precise heating of mineral and synthetic oils in industrial processes, for example, oil preheating in hydraulic systems and machinery.

These systems allow significant advantages over traditional resistive heating systems:

- Reduced energy consumption and more efficient heat transmission
- Reduced heating time due to high heat exchanged per unit volume
- Uniform heat distribution within the fluid up to 60°C, avoiding dangerous localized overheating
- Compatibility with fluids of various viscosities [10 ÷ 500 mm²/s]
- Possible integration in off-line filtration circuits
- High reliability and long life service

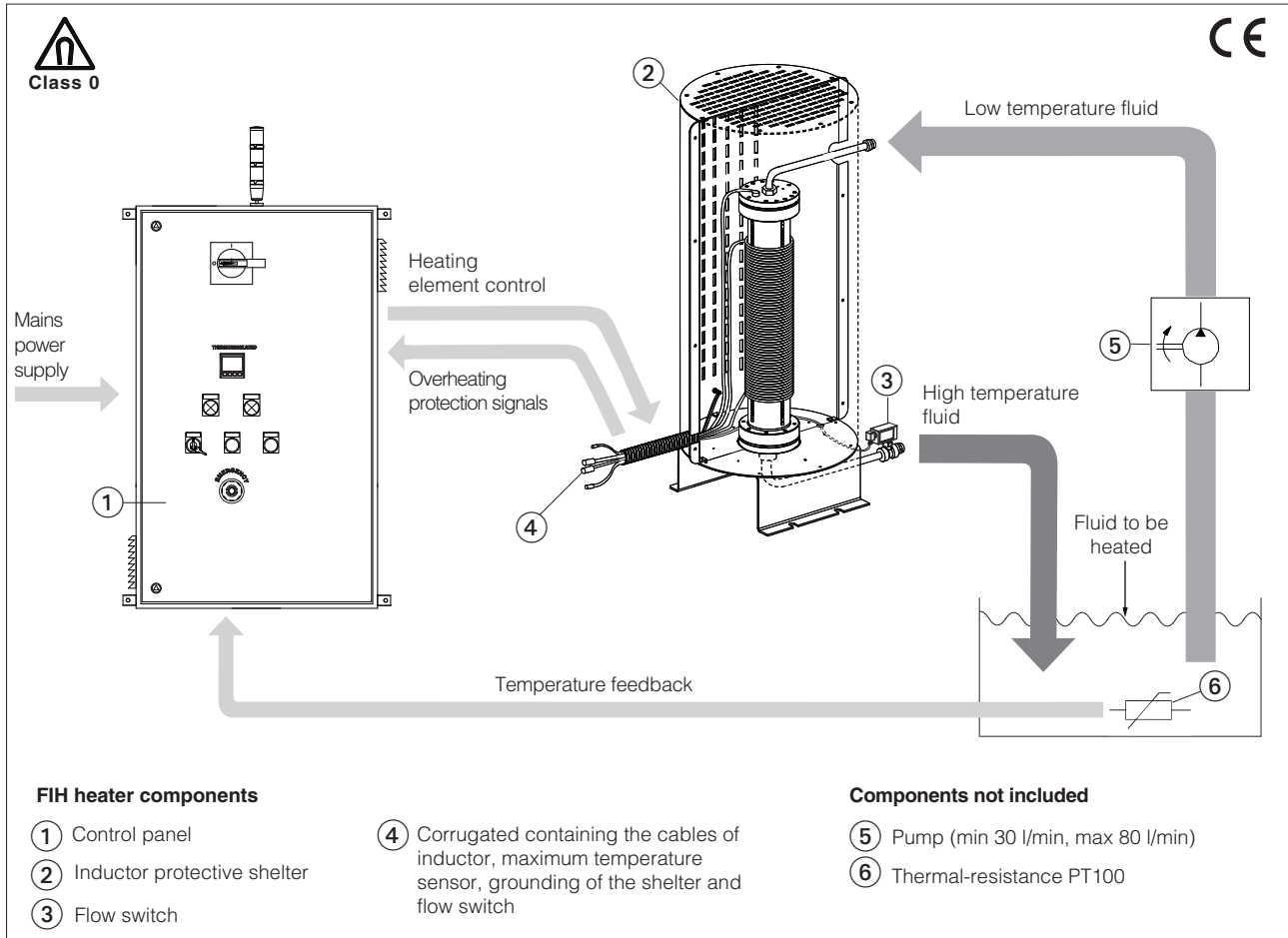

1 MODEL CODE

FIH	-	H	-	T400VAC	/	60	-	10	-	80	05	*
Induction heater for oleohydraulic fluids												
Nominal power H = 15 kW												
Power supply (1) T400VAC for 380-400VAC - 50/60Hz three-phase T460VAC for 440-460VAC - 50/60Hz three-phase												
Maximum fluid outlet temperature (2) 60 = 60°C												
Maximum pressure 10 = 10 bar												
Length of inductor connection cable 05 = 5 m 10 = 10 m												
Maximum flow rate 80 = 80 l/min												
Series number												

(1) For different supply voltages, please contact Atos Induction's technical department

(2) For higher temperatures, please contact Atos Induction's technical department

2 FUNCTIONAL DESCRIPTION

The fluid heater is designed to heat mineral and synthetic oils (not water-based fluids) through the electromagnetic induction principle. The FIH system consists of an inductor, supplied pre-assembled for connection to the hydraulic circuit, and a control panel.

2.1 Inductor

The inductor is composed of a coil wound on a resin tube; at the ends of the tube there are the hydraulic inlet and outlet connections for the fluid passage. Inside the tube there are a series of steel spheres, of uniform diameter, in direct contact with the fluid. When the inductor is powered, the magnetic field generated by the coil penetrates inside the cylinder and heats the steel spheres because of the magnetic induction. The fluid is heated by direct contact with the sphere surfaces, obtaining a uniform distribution of the temperature inside, and avoiding localized overheating as in common resistance heaters. The inductor is equipped with two pre-installed safety systems: a maximum temperature sensor mounted on the upper head, which measures the inductor temperature, and a flow switch located on the outlet pipe, which enables heating only in the presence of fluid flow rate and avoids spheres overheating.

During the heating process the inductor generates an electromagnetic field that could be dangerous for the health of the operators in the close vicinity. The heating element is supplied with a protective shelter which reduces field emissions below human safety limits (Class 0 - UNI EN 12198). The shield is made up of two half-shells, placed on the inductor support.

It is forbidden to remove the shield when the heater is running. If the heater must be started up without shelter or with open shelter, e.g., for maintenance work, it is necessary to ensure a buffer zone around the inductor, with a radius of 1400 mm, inside which access by operators is prohibited. To remove the shelter, see the user and maintenance manual

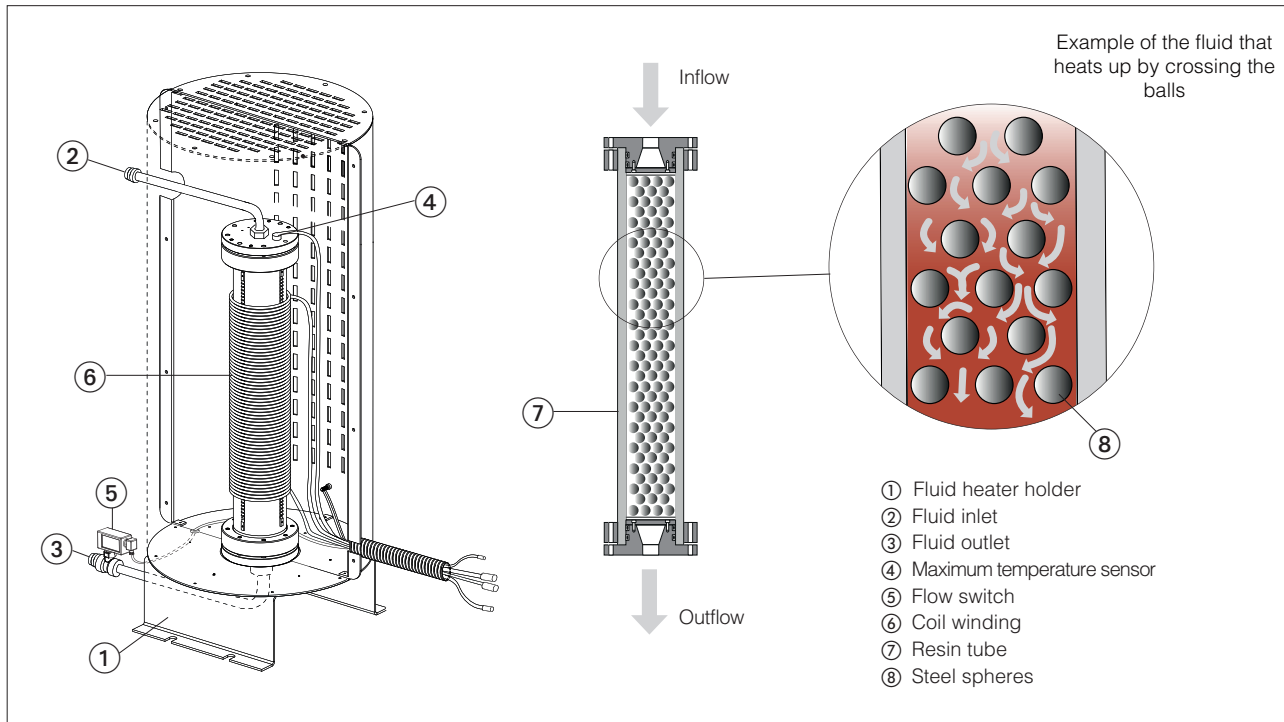

2.2 Control panel

The control panel powers the inductor and manages the control logic of the heating cycle and the system diagnostics. The control panel contains the EPG power generator (see table AI100), the thermoregulator and terminal blocks for the connection of the system components. The fluid temperature is precisely regulated in closed-loop control by ON/OFF modulation of the enabling signal sent to the internal EPG generator.

The following diagram shows the logic of the FIH thermoregulated control.

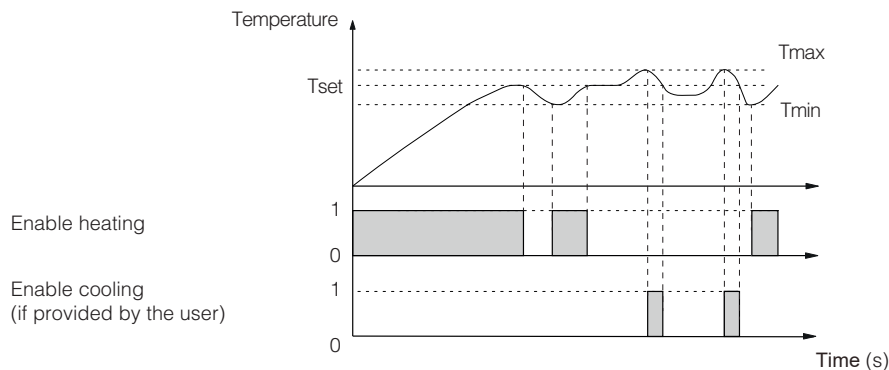

When the heater is started, the fluid temperature increases until it reaches the selected value T_{set} ; once the set point is reached, without external heat sources, the heater control maintains the fluid temperature between the values T_{min} and T_{set} . The temperature T_{min} is the value below which the thermoregulator starts heating the oil; T_{min} is automatically set 2°C under the selected T_{set} and cannot be changed.

The control panel provides a contact to automatically activate a fluid cooling system, if provided by the customer. The temperature T_{max} represents the value whereby the thermoregulator enables the oil cooling, until it returns to the temperature T_{set} . T_{max} is automatically set $0,5^{\circ}\text{C}$ above the selected T_{set} and is not modifiable.

3 MAIN CHARACTERISTICS

Inductor position	Vertical
Electrical panel position	Wall mounting. The panel must be positioned so that anyone can easily reach all the controls
Ambient temperature range (for electrical panel)	0°C ÷ +40°C
Ambient humidity range (for electrical panel)	30% ÷ 60%
IP protection degree [CEI EN 605229]	Control panel: IP54
	Inductor: not applicable, avoid contact between the external surface of the tube and liquids
Electromagnetic emissions [EN UNI 12198]	Class 0
Compliance	EC Declaration of Conformity valid in accordance with the directives: EMC 2014/30/UE (EN 61000-6-2; EN 61000-6-4); Low voltage 2014/35/UE (EN 60519-1; EN 60519-3); RoHS 2011/65/UE; REACH (CE n° 1907/2006)

4 ELECTRICAL CHARACTERISTICS

Nominal power	[kW]	15 ± 15%
Power supply		3x400 ± 10% VAC o 3x460 ± 10% VAC
Input current (±5%)	T400VAC [A]	22,8
	T460VAC [A]	19,8
Frequency	[Hz]	50 ÷ 60
Power factor (cos φ)		0,95
Electrical protections		The control panel contains all the necessary protection devices
Control panel power cable		FG16OR16 4X10 mm ² (three-phase + ground) - not included
External cooling system control		24 VDC - 2 A

5 HYDRAULIC CHARACTERISTICS

Max fluid heating temperature	[°C]	60
Max inlet fluid pressure	[bar]	10
Flow rate	[l/min]	min 30, max 80
Fluid pressure drop inlet / outlet	[bar]	2 (with 80 l/min flow rate and 500 mm ² /s fluid viscosity)
Admissible viscosity	[mm ² /s]	10 ÷ 500
Hydraulic connections inlet / outlet		G1"
Fluid filtration degree		ISO 4406 class 20/18/15

The FIH heater is designed to operate with the following fluids type:

HYDRAULIC FLUID	CLASSIFICATIONS	REFERENCE STANDARD
Mineral and synthetic oils	HL, HLP, HLPD, HVL, HVLDP, HF, HFDR	DIN 51524; ISO 12922

For fluids not included in the table, consult the Atos Induction technical department.

 Water-based fluids are not permitted because they may damage the heater

The chart below shows the time required to heat different volumes of ISO VG 46 oil.

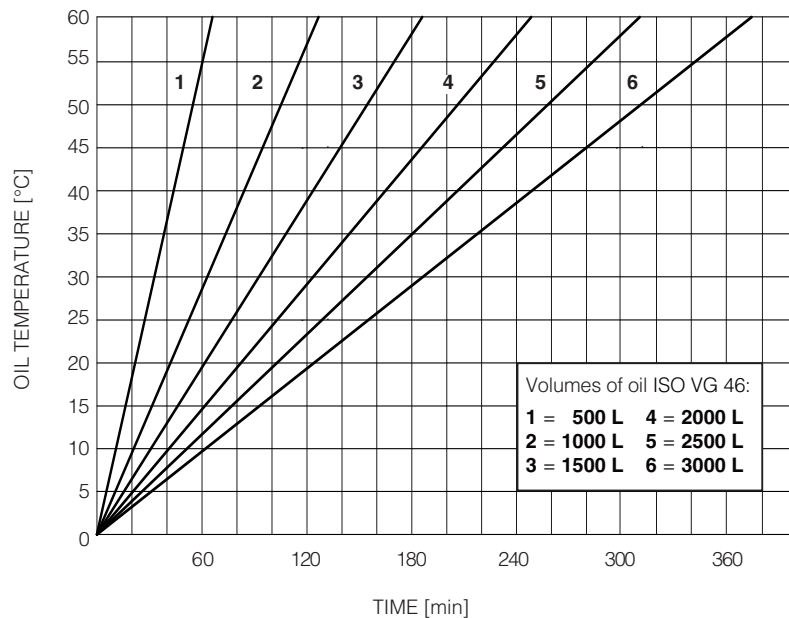

6 CONTROL PANEL AND SIGNALLING STOPLIGHT

The front control panel is equipped with buttons and indicator lights to manage the heating process. At the top of the panel there is a stoplight for remotely visualise of the operating status of the system.

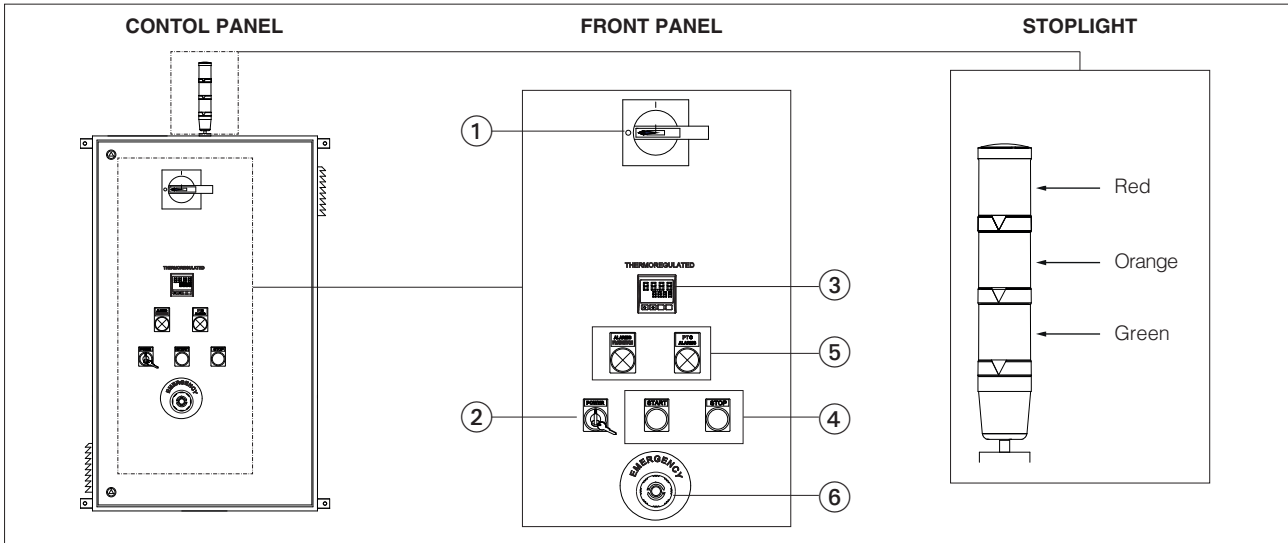

General disconnecter ①

The general disconnecter links the control panel to the power grid and enables the control circuit 24 VDC of the panel.

Turn the switch to ON to connect the control panel to the mains.

Turn the switch to OFF to disconnect the control panel from the mains.

The general disconnecter must be in the OFF position to open the front door of the cabinet.

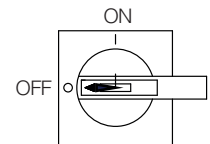

Key switch ②

It allows to activate the panel internal power supplies and to prepare the heater to be started.

Switch ON: turn the key to the right to **2**, hold for five seconds to enable the power supply to the generator and the thermoregulator.

Once released, the key automatically returns to position **0** and cannot be removed. Orange lights up on the stoplight.

If the heating element is not correctly connected to its terminals, the control panel cannot be activated, and the stoplight illuminates red.

Switch OFF: turn the key to the left to **1** to shut down the control panel. In this position, the key can be removed to prevent the activation of the panel.

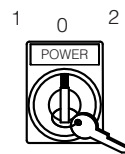

Thermoregulator ③

The thermoregulator controls the fluid temperature in closed loop according to the thermoregulated control logic described in section 2.2.

The selected temperature Tset is shown on the digital display. Press the buttons \uparrow \downarrow to change the temperature up to 60°C maximum.

The user must place a PT100 thermo-resistor in the fluid tank and connect it to the control panel, as shown in section 8.

THERMOREGULATED

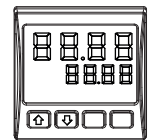

Heating ④

The START/STOP buttons can be used to control the heating process.

START: after setting the thermoregulator, press the button to power up the inductor and start heating the fluid. The stoplight turns green.

STOP: press the button to de-energise the inductor and stop the heating process. The stoplight turns orange.

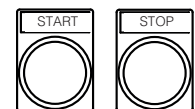

Alarms ⑤

In order to prevent possible overheating, the heater is equipped with protection systems that interrupt or do not allow the heater start up in the presence of a malfunction:

- Flow switch (supplied with the system): ensures to operates only in presence of fluid flow through the inductor
- Maximum temperature sensor (supplied with the system): monitors that the inlet head temperature does not exceed the safeguard value +70°C. The heating cycle cannot be reactivated until the temperature returns within the safety threshold

Two alarm lights corresponding to the sensors are positioned on the control panel:

ALARM FLOW SWITCH: absence of fluid flow. The stoplight lights red.

PTC ALARM: inductor inlet head temperature greater than 70°C. The stoplight lights red.

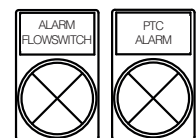

Note: In case of anomaly the inductor power supply is always interrupted

 If the stoplight turns red and simultaneously both warning lights are off, this means that there is an internal failure. Check the connections of mains power supply and coil. If the problem persists, contact Atos Induction technical service

 In case of thermo-resistor breakage, the inductor supply and the fluid heating are interrupted. The stoplight turns red, and an error message appears on the display of the thermoregulator. The heating can be restarted once the thermo-resistor fault has been solved

Emergency stop ⑥

In the case of an emergency, press the button EMERGENCY STOP to switch off the heater completely.



Enabling cooling: The control panel provides a 24 VDC - 2 A source to automatically enable any customer cooling system. See section 2.2 for cooling enable logic.

7 INSTALLATION PRESCRIPTIONS

The inductor can be connected to a dedicated hydraulic circuit or, if present, it is possible to exploit the off-line filtration circuit, checking the flow and pressure characteristics.

In addition to the heating process, the FIH system can also manage the customer's cooling system to allow total control of the fluid temperature.

7.1 Requirements and equipment

- Admissible fluid flow rate from 30 l/min to 80 l/min.

Warning: an insufficient flow could overheat the oil and damage the inductor. It is forbidden to power the inductor without fluid flow; these data must be considered to select a compatible pump

- Maximum inlet pressure 10 bar
- The thermoregulated process requires the installation of a temperature sensor in the fluid tank; to this end, it is necessary to connect a PT100 thermo-resistance (not included) to the control panel, see section 8

The following example shows the integration of the FIH heater into a typical off-line circuit.

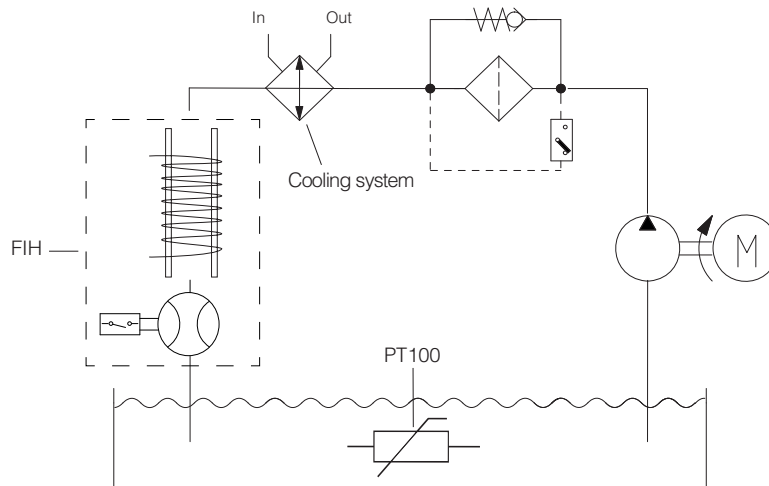

7.2 Electrical connections

To connect the cables to the control panel, open the panel front door, insert each of them through the corresponding cable gland (located on the bottom side of the panel) and connect the cable ends to the appropriate terminal blocks. See section 8 for connection specifications.

Connection to the power grid

The control panel must be connected to the mains in accordance with the applicable safety and industrial systems country requirements.

Connection of the corrugated containing the cables of inductor, maximum temperature sensor, grounding of the shelter and flow switch

The cables of inductor, maximum temperature sensor, grounding of the shelter and flow switch are supplied pre-laid together in a corrugated tube. To connect the components, clamp the corrugated pipe to the fitting (located at the bottom of the panel) and connect the cable ends to the corresponding terminals.

Note: the inductor protective shelter needs to be connected to ground in order to perform shielding function correctly

Warning: The control panel can supply only one inductor at a time, so it is not possible to connect several inductors to a panel

Warning: Use only the cables supplied with the heater. Due to their special design, the inductor connection cables cannot be shortened or extended. Please select the required length carefully from the available lengths, see section 11

Connection of PT100 thermo-resistor

The thermo-resistor is necessary to monitor the temperature of the fluid tank and to perform temperature control. For correct temperature measurement, use only 2- or 3-wire PT100 sensors. It is advisable to choose shielded sensors to reduce possible interference.

Connection of external cooling device (if present)

Verify that the cooling system can be properly driven through the 24 VDC - 2 A source provided by the control panel.

Warning: All connections must be performed exclusively by qualified personnel

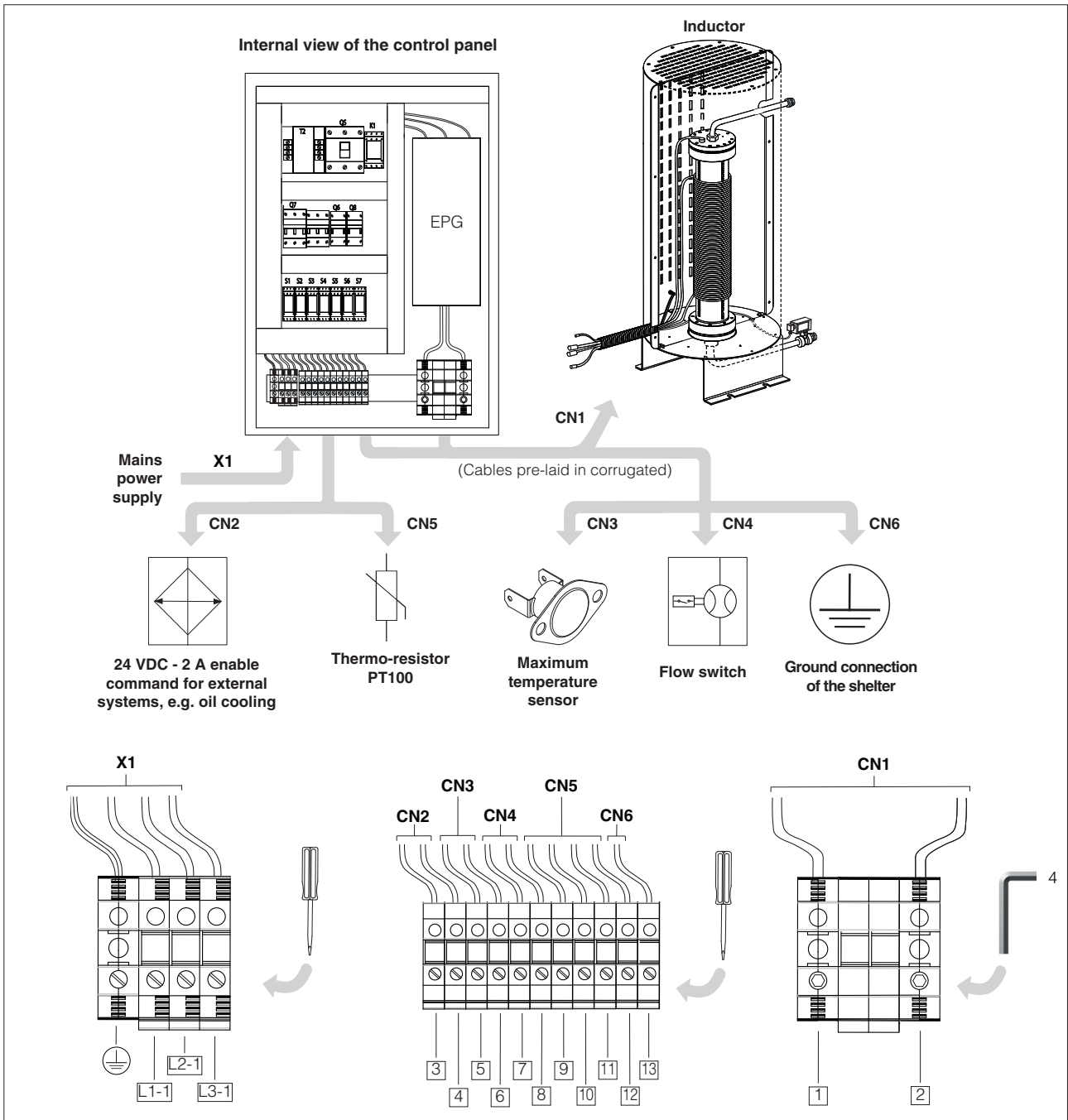

TERMINAL BLOCKS	PIN	TECHNICAL SPECIFICATIONS	NOTE		
X1 (3)	L1-1	3x400 VAC or 3x460 VAC	Mains power connection		
	L2-1				
	L3-1		Ground connection		
	Yellow / green				
CN1	1		Inductor connection		
	2				
CN2 (4)	3	0 VDC	Cooling down OFF	Output - enable command for external systems	
	4	24 VDC (2 A)	Cooling down ON		
CN3	5	24 VDC (5 A max)	Open	Excessive temperature	Input - maximum temperature sensor
	6		Closed	Adequate temperature	
CN4 (4)	7	24 VDC (5 A max)	Open	Insufficient flow rate	Input - flow switch connection
	8		Closed	Adequate flow	
CN5 (4)	9		Red	Input - thermo-resistor PT100 (5)	
	10		White		
	11		Red		
	12		Shield (optional)		
CN6 (3)	13		Yellow / green	Ground connection of the shelter	

(3) Cable section: min.10 mm²; max.16 mm²; (4) Max. cable section 2,5 mm²

(5) Ready for three-wire PT100 sensor + shield cable (optional). For connection of two-wire sensors, jumper terminals 9 and 11

9 INDUCTOR DIMENSIONS [mm]

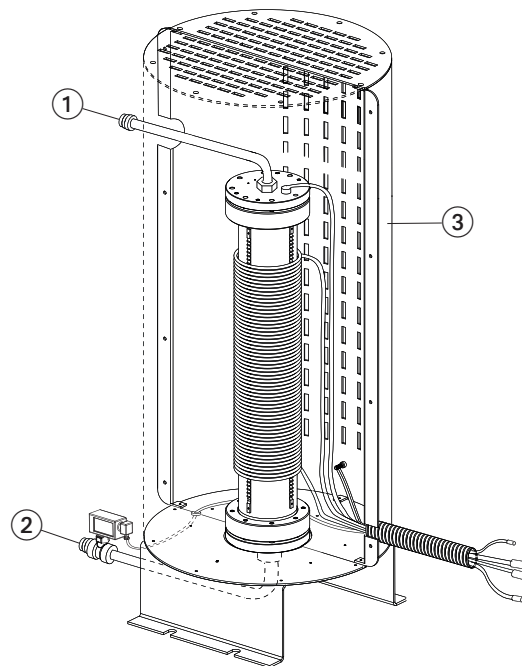
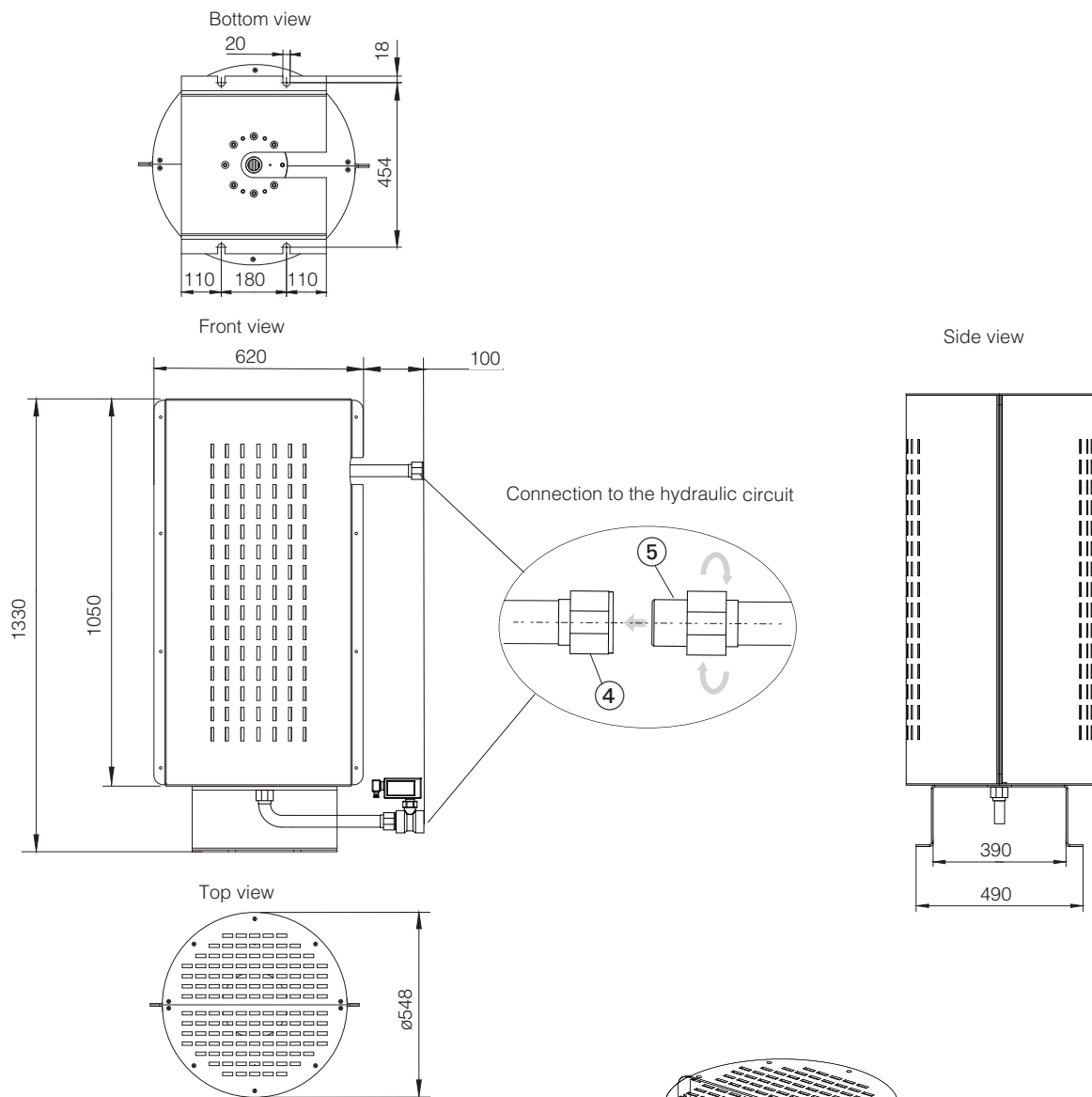

- ① Fluid inlet connection
- ② Fluid outlet connection
- ③ Shelter
- ④ G1" female connection (included)
- ⑤ G1" male connection (not included)

10 CONTROL PANEL DIMENSIONS [mm]

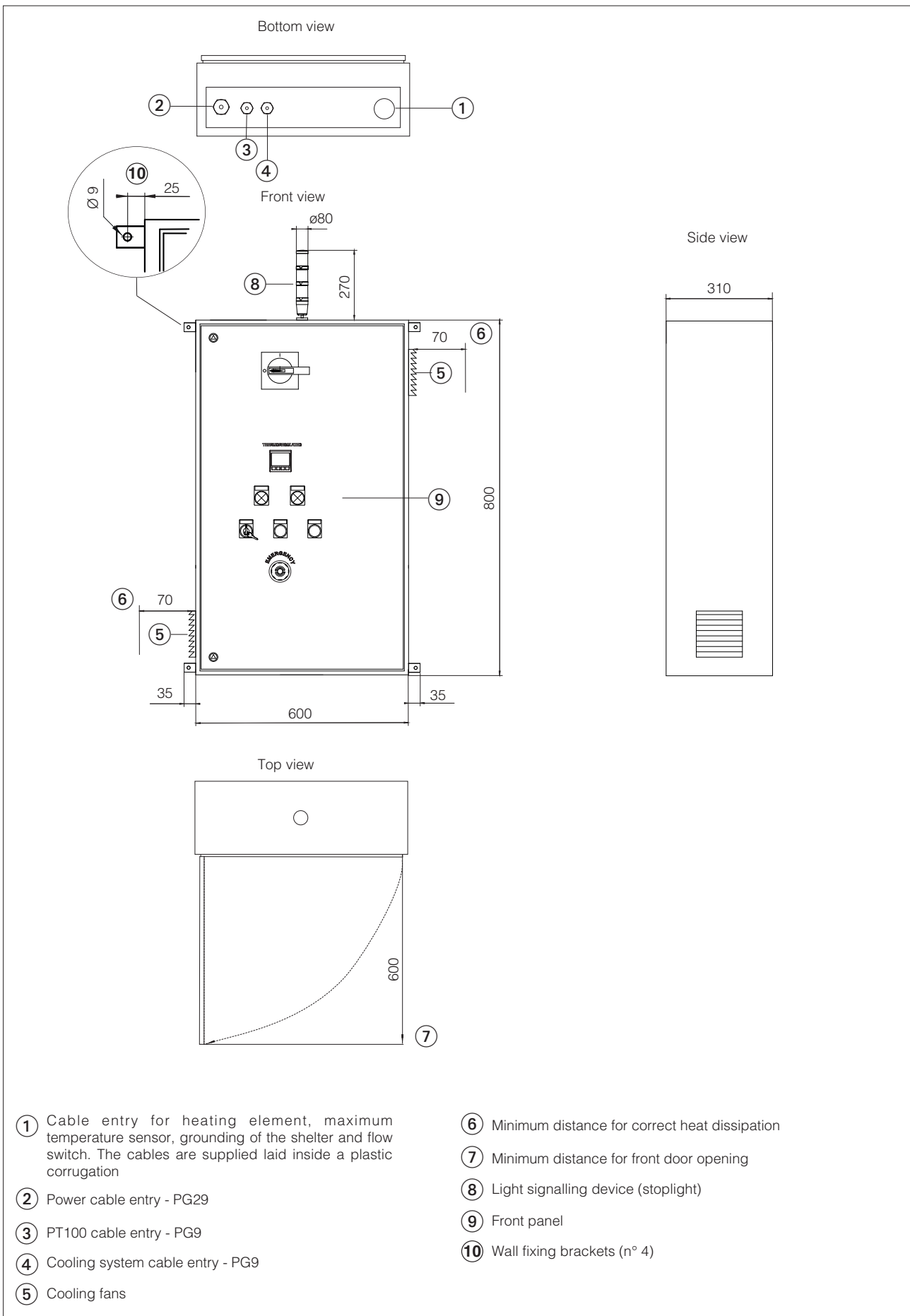

- ① Cable entry for heating element, maximum temperature sensor, grounding of the shelter and flow switch. The cables are supplied laid inside a plastic corrugation
- ② Power cable entry - PG29
- ③ PT100 cable entry - PG9
- ④ Cooling system cable entry - PG9
- ⑤ Cooling fans
- ⑥ Minimum distance for correct heat dissipation
- ⑦ Minimum distance for front door opening
- ⑧ Light signalling device (stoplight)
- ⑨ Front panel
- ⑩ Wall fixing brackets (n° 4)

11 RELATED DOCUMENTATION

AI100 Electronic power generators