

# Modular relief valves type SHMP, SKM

ISO 4401 sizes 06 and 10

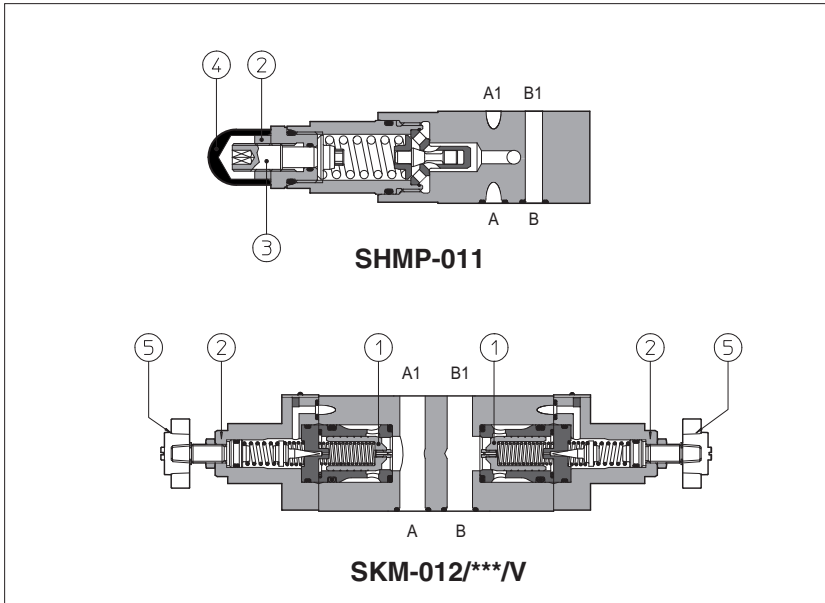

**SHMP** are direct operated pressure relief valves, size 06.

**SKM** are double stage pressure relief valves size 10 with balanced poppet ①.

The pressure adjustment is operated by loosening the locking nut ② and turning the screw ③ protected by cap ④. Optional versions with setting adjustment by handwheel ⑤ instead of the screw are available on request. Clockwise rotation increases the pressure.

Valve size and max flow:

**SHMP** = size 06, max flow: 35 l/min

**SKM** = size 10, max flow: 120 l/min

Mounting surface: **ISO 4401 size 06, 10**

Max pressure: up to **350 bar**

## 1 MODEL CODE

<b>SHMP</b>	-	<b>011</b>	/	<b>210</b>	/	<b>V</b>	/	<b>**</b>	/	<b>*</b>
Modular pressure relief valve size: <b>SHMP</b> = 06 <b>SKM</b> = 10								Series number		Seals material, see section 5: - = NBR <b>PE</b> = FKM <b>BT</b> = HNBR
Configuration, see section 2								Options: <b>V</b> = setting adjustment by handwheel instead of a grub screw protected by cap		
<b>011</b> = single on port P, discharge to port T <b>012</b> = double on ports A and B, discharge to port T <b>013</b> = single on port A, discharge to port T <b>014</b> = single on port B, discharge to port T <b>015</b> = double on ports A and B, with the relieved pressure cross-discharged										
				Pressure range		<b>SHMP:</b> <b>50</b> = 2÷ 50 bar <b>100</b> = 3÷100 bar <b>210</b> = 10÷210 bar <b>350</b> = 15÷350 bar		<b>SKM:</b> <b>50</b> = 4÷ 50 bar <b>100</b> = 5÷100 bar <b>210</b> = 5÷210 bar <b>350</b> = 5÷350 bar		

## 2 HYDRAULIC CONFIGURATION

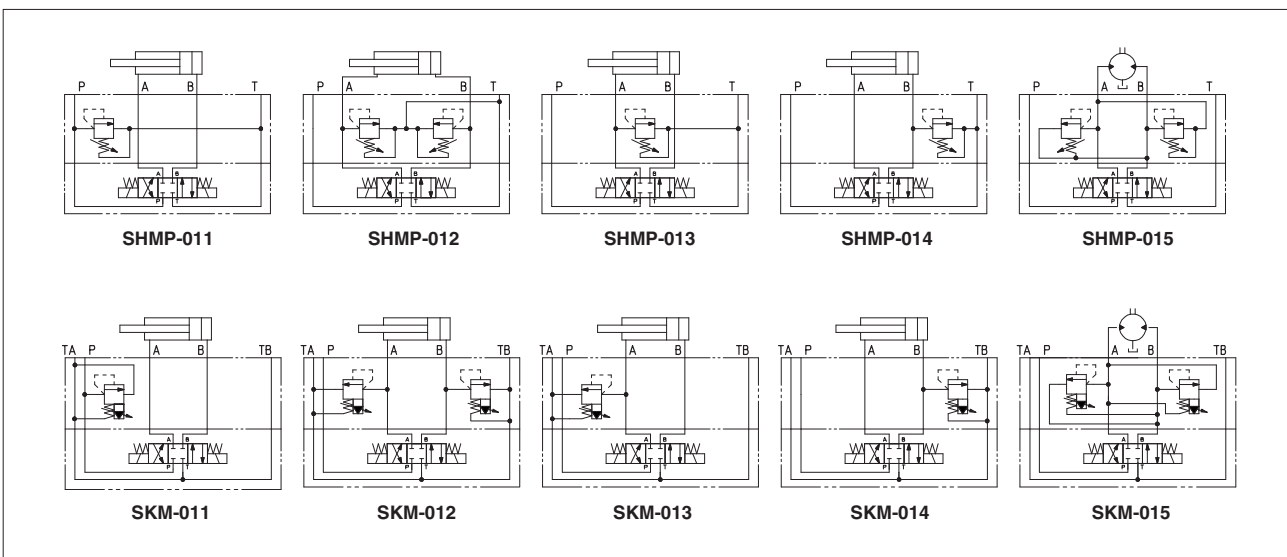

### 3 GENERAL CHARACTERISTICS

Assembly position / location	Any position
Subplate surface finishing	Roughness index Ra 0,4 - flatness ratio 0,01/100 (ISO 1101)
MTTFd values according to EN ISO 13849	150 years, for further details see technical table P007
Ambient temperature	Standard execution = -30°C ÷ +70°C /PE option = -20°C ÷ +70°C /BT option = -40°C ÷ +70°C

### 4 HYDRAULIC CHARACTERISTICS

Valve model		<b>SHMP</b>	<b>SKM</b>
Max flow [l/min]		35	120
Pressure range [bar]		2÷50; 3÷100; 10÷210; 15÷350	4÷50; 5÷100; 5÷210; 5÷350

### 5 SEALS and HYDRAULIC FLUIDS - for other fluids not included in below table, consult our technical office

Seals, recommended fluid temperature	NBR seals (standard) = -20°C ÷ +80°C, with HFC hydraulic fluids = -20°C ÷ +50°C FKM seals (/PE option) = -20°C ÷ +80°C HNBR seals (/BT option) = -40°C ÷ +60°C, with HFC hydraulic fluids = -40°C ÷ +50°C		
Recommended viscosity	15÷100 mm <sup>2</sup> /s - max allowed range 2.8 ÷ 500 mm <sup>2</sup> /s		
Max fluid contamination level	ISO4406 class 20/18/15 NAS1638 class 9, see also filter section at <a href="http://www.atos.com">www.atos.com</a> or KTF catalog		
<b>Hydraulic fluid</b>	<b>Suitable seals type</b>	<b>Classification</b>	<b>Ref. Standard</b>
Mineral oils	NBR, FKM, HNBR	HL, HLP, HLPD, HVLP, HVLPD	DIN 51524
Flame resistant without water	FKM	HFDR, HFDR	ISO 12922
Flame resistant with water	NBR, HNBR	HFC	

### 6 REGULATED PRESSURE VERSUS FLOW DIAGRAMS (Based on mineral oil ISO VG 46 at 50°C)

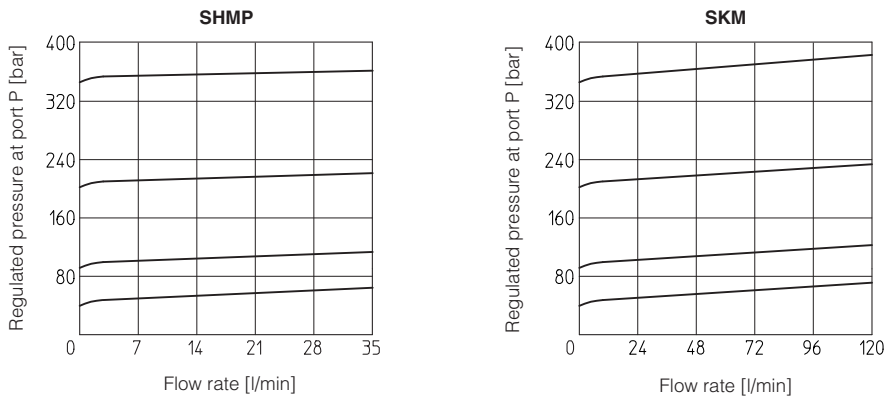

### 7 MINIMUM PRESSURE VERSUS FLOW DIAGRAMS (Based on fluid viscosity of 25 mm<sup>2</sup>/s at 40°C)

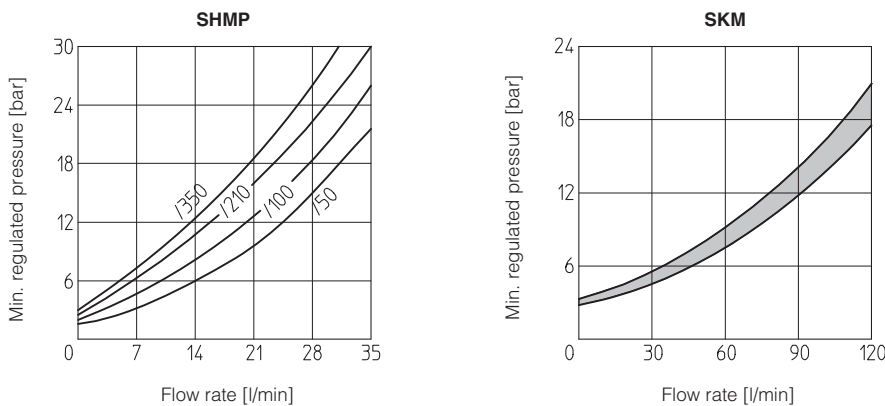

8 INSTALLATION DIMENSIONS OF SHMP VALVES [mm]

SHMP-011

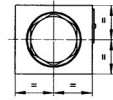
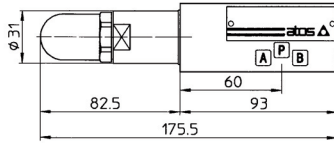
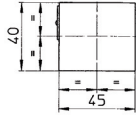

Mass: 1,4 Kg

SHMP-012

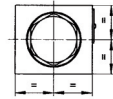
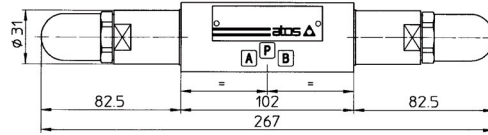
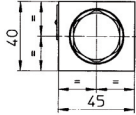

Mass: 1,7 Kg

SHMP-013  
SHMP-014

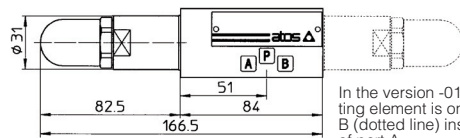
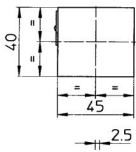

In the version -014 the regulating element is on side of port B (dotted line) instead of side of port A.

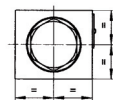

Mass: 1,2 Kg

SHMP-015

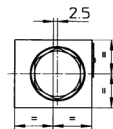
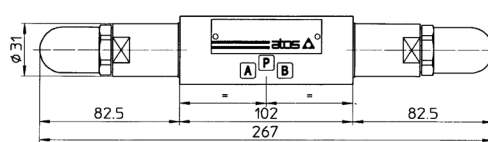
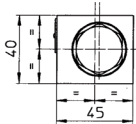

Mass: 1,7 Kg

Adjustment device for option /V

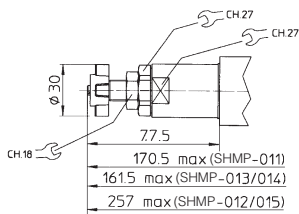

ISO 4401: 2005

Mounting surface: 4401-03-02-0-05

Diameter of ports A, B, P, T:  $\varnothing = 7,5$  mm

Seals: 4 OR 108

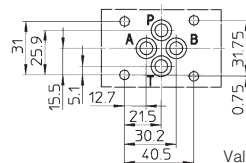

Valve's bottom view

Fastening bolts: n° 4 socket head screws M5. The length depends on number and type of modular elements associated.

9 INSTALLATION DIMENSIONS OF SKM VALVES [mm]

SKM-011

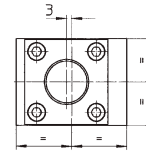
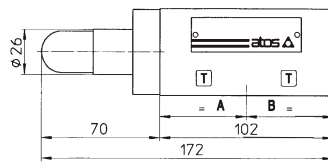
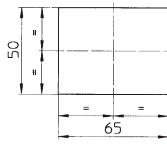

Mass: 2,5 Kg

SKM-012

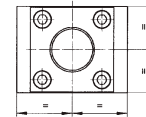
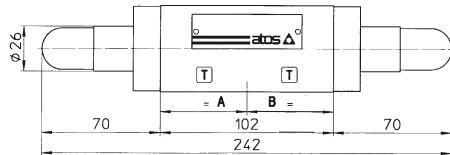
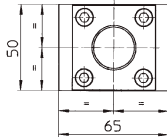

Mass: 2,8 Kg

SKM-013

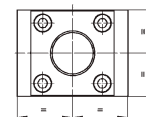
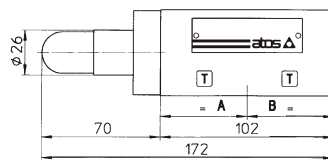
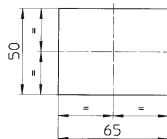

Mass: 2,5 Kg

SKM-014

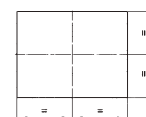
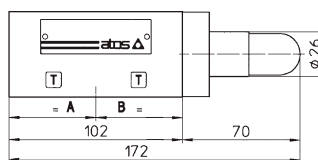
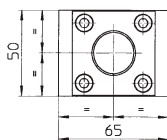

Mass: 2,5 Kg

SKM-015

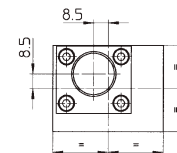
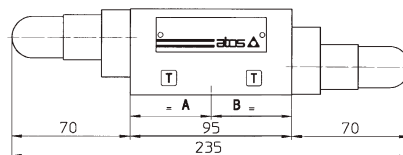
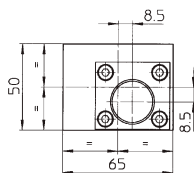

Mass: 2,5 Kg

Adjustment device for option /V

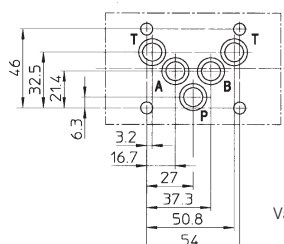
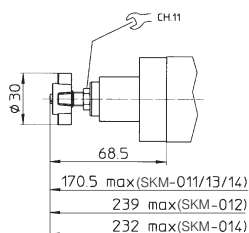

Valve's bottom view

ISO 4401: 2005

Mounting surface: 4401-05-04-0-05

Diameter of ports A, B, P, T:  $\phi = 11,2$  mm

Seals: 5 OR 2050

Fastening bolts: n° 4 socket head screws M6. The length depends on number and type of modular elements associated.