

Hydraulic operated directional valves type SDPL

spool type, max pressure 280 bar

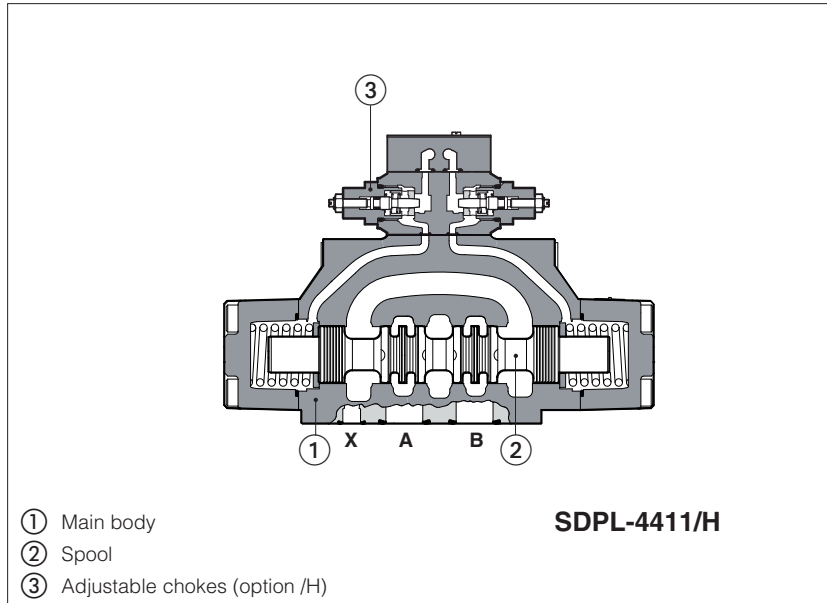

Spool type hydraulic operated directional valves available in three or four way configurations.

These valves are specifically designed for medium pressure applications such as in the plastics sector.

Mounting surface: **ISO 4401**

size 16, 25

SDPL-2 = size 16, flow up to 300 l/min

SDPL-4 = size 25, flow up to 700 l/min

Max pressure: **280 bar**

1 MODEL CODE

SDPL-2	4	1	3	/	H	**	/	*
Hydraulic operated directional control valve, Pmax = 280 bar size: SDPL-2 = 16 SDPL-4 = 25						Series number		Seals material, see section 4: - = NBR PE = FKM
Type of actuator: 4 = single actuator 5 = double actuator						Options: /H = adjustable chokes for controlling the main spool shifting time (meter-out to the pilot chambers of the main valve) /R = pilot pressure generator (4 bar on port P) /S = main spool stroke adjustment		
Valve configuration, see section 2 : 0 = free, without springs 1 = spring centered, without detent 3 = spring offset external position 7 = center and external positions						Spool type, see section 2		

2 CONFIGURATIONS and SPOOLS valves type SDPL-*

Configurations	Spools	Configurations	Spools
41		43	
47		50	
51			

Special shaped spools

- spools type **0** and **3** are also available as **0/1** and **3/1** with restricted oil passages in central position, from user ports to tank.
- spools type **1** and **4** are also available as **1/1** and **4/8** are properly shaped to reduce water-hammer shocks during the switching.

3 HYDRAULIC CHARACTERISTICS

Valve model		SDPL-2	SDPL-4
Max recommended flow	[l/min]	300	700
Max pressure on port P, A, B	[bar]	280	
Max pressure on port T (also X, Y for SDPL)	[bar]	210	
Minimum pilot pressure	[bar]	4	
Max recommended pressure on piloting line	[bar]	210	

(1) The max pressure on port T has to be not over 50% of pilot pressure

4 MAIN CHARACTERISTICS, SEALS AND FLUIDS - for other fluids not included in below table, consult our technical office

Assembly position / location	any position except for valves type SDPL-*50 (without springs) that must be installed with their longitudinal axis horizontal		
Subplate surface finishing	roughness index Ra 0,4 - flatness ratio 0,01/100 (ISO 1101)		
MTTFd values according to EN ISO 13849	150 years, for further details see technical table P007		
Ambient temperature range	standard execution = -30°C ÷ +70°C; /PE option = -20°C ÷ +70°C;		
Seals, recommended fluid temperature	NBR seals (standard) = -20°C ÷ +80°C, with HFC hydraulic fluids = -20°C ÷ +50°C FKM seals (/PE option) = -20°C ÷ +80°C		
Recommended viscosity	15 ÷ 100 mm ² /s - max allowed range 2,8 ÷ 500 mm ² /s		
Max fluid contamination level	ISO4406 class 20/18/15 NAS1638 class 9, see also filter section at www.atos.com or KTF catalog		
Hydraulic fluid	Suitable seals type	Classification	Ref. Standard
Mineral oils	NBR, FKM	HL, HLP, HLPD, HVLP, HVLPD	DIN 51524
Flame resistant without water	FKM	HFDU, HFDR	ISO 12922
Flame resistant with water	NBR	HFC	

5 Q/ΔP DIAGRAMS

SDPL-2	See note and diagrams on table SHE085 relating the SDPH*-2 valve from which SDPL-2* are derived
SDPL-4	See note and diagrams on table SHE085 relating the SDPH*-4 valve from which SDPL-4* are derived

6 PILOT PRESSURE GENERATOR (option /R)

The device /R generates an additional pressure drop, in order to ensure the minimum pilot pressure, for correct operation of the valves with internal pilot and fitted with spools type **0, 0/1, 4, 4/8, 5, 5/8, 9**. The device /R has to be fitted when the pressure drop in the valve, verified on flow versus pressure diagrams, is lower than the minimum pilot pressure value.

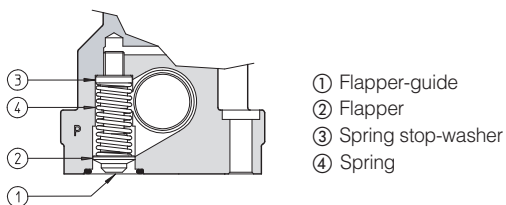

7 DIMENSIONS OF HYDRAULIC OPERATED VALVES ISO 4401 size 16, 25 and 32 [mm]

SDPL-2

ISO 4401: 2005

Mounting surface: 4401-07-07-0-05

Fastening bolts:

4 socket head screws M10x50 class 12.9

Tightening torque = 70 Nm

2 socket head screws M6x45 class 12.9

Tightening torque = 15 Nm

Diameter of ports A, B, P, T: $\varnothing = 20$

Diameter of ports X, Y: $\varnothing = 7$ mm

Diameter of port L: $\varnothing = 5$ mm

Seals: 4 OR 130, 2 OR 2043

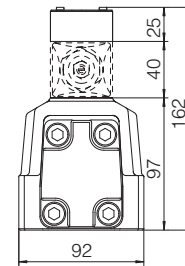
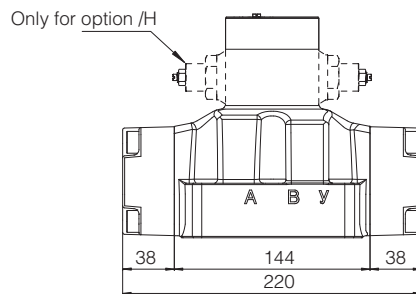
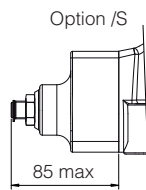
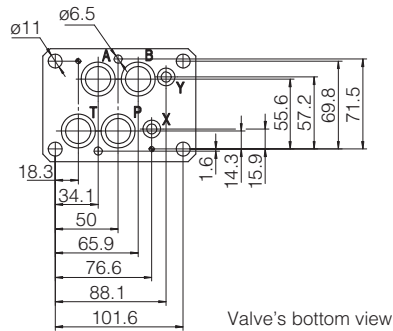

Mass: 10 Kg

SDPL-4

ISO 4401: 2005

Mounting surface: 4401-08-08-0-05

Fastening bolts:

6 socket head screws M12x60 class 12.9

Tightening torque = 125 Nm

Diameter of ports A, B, P, T: $\varnothing = 24$

Diameter of ports X, Y: $\varnothing = 7$ mm

Diameter of port L: $\varnothing = 5$ mm

Seals: 4 OR 4112, 2 OR 3056

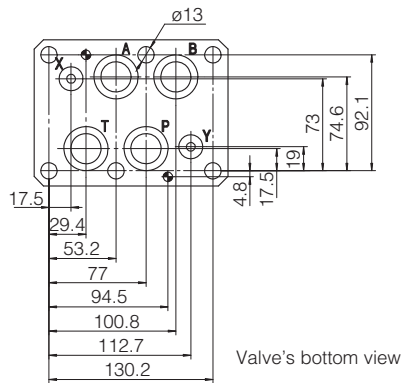

- P** = PRESSURE PORT
- A, B** = USE PORT
- T** = TANK PORT
- X** = EXTERNAL OIL PILOT PORT
- Y** = DRAIN PORT

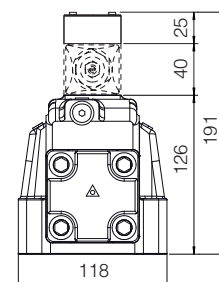
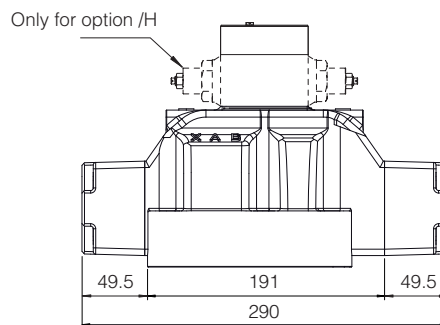
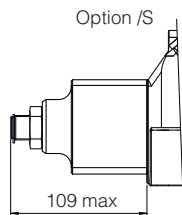

Mass: 16,5 Kg