

# Proportional relief valves

direct operated, ISO 4401 size 06 subplate mounting or M20 screw-in cartridge execution

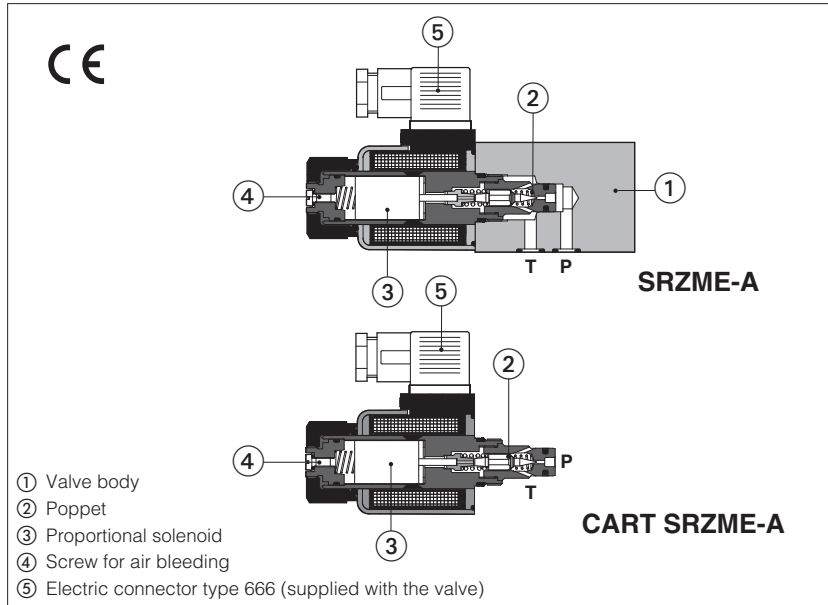

**SRZME-A, CART SRZME-A**

Poppet type direct operated proportional relief valves for pressure open loop controls, available in following executions:

**SRZME:** subplate mounting, ISO size 06

**CART SRZME:** M20 cartridge execution

They operate in association with electronic drivers, see section 2, which supply the proportional valves with proper current to align the valve regulation to the reference signal.

The solenoid coils are available with different nominal resistances depending to the voltage supply to the electronic driver (12 VDC or 24 VDC) and to the driver characteristics, see section 2 and 3.

Mounting surface SRZME: **ISO 4401 size 06**

Cavity CART SRZME: see section 10

Max flow = **4 l/min**

Max pressure = **350 bar**

**1 MODEL CODE**

<b>SRZME</b>	-	<b>A</b>	-	<b>010</b>	/	<b>315</b>	-	<b>*</b>	/	<b>*</b>	/	<b>**</b>	/	<b>*</b>
Proportional pressure relief valve <b>SRZME</b> = subplate mounting <b>CART SRZME</b> = cartridge execution		<b>A</b> = open loop pressure control												Seals material, see section 4: - = NBR <b>PE</b> = FKM <b>BT</b> = HNBR
<p><b>Configuration:</b> <b>010</b> = regulation on port P, discharge in T</p> <p><b>Max regulated pressure:</b>  <b>50</b> = 50 bar  <b>100</b> = 100 bar  <b>210</b> = 210 bar  <b>315</b> = 315 bar  <b>350</b> = 350 bar</p>														<p><b>Coil voltage</b> see section 2 and 3:  - = standard coil for 24V<sub>DC</sub> Atos drivers  <b>6</b> = optional coil for 12V<sub>DC</sub> Atos drivers  <b>18</b> = optional coil for low current drivers (1)</p>
<p><b>Coils with special connectors</b>, see section 9  - = omit for standard DIN connector  <b>J</b> = AMP Junior Timer connector  <b>K</b> = Deutsch connector  <b>S</b> = Lead Wire connection</p>														

(1) select valve's coil voltage /18 in case of electronic drivers not supplied by Atos, with power supply 24V<sub>DC</sub> and with max current limited to 1A.

**2 ELECTRONIC DRIVERS** - see www.atos.com or KTI industrial master catalog

Drivers model	E-MI-AC (1)		E-MI-AS-IR (1)		E-BM-AS-PS		E-BM-AES
Type	analog		digital		digital		digital
Voltage supply (V <sub>DC</sub> )	12	24	12	24	12	24	24
Valve coil option	/6	std	/6	std	/6	std	std
Format	DIN 43650 plug-in to solenoid				DIN-rail panel		
Data sheet	G010		G020		G030		GS050

(1) for **CART SRZME** the electronic driver may interfere with the manifold surface. Please check the installation dimensions at section 10

**3 HYDRAULIC CHARACTERISTICS** (based on mineral oil ISO VG 46 at 50 °C)

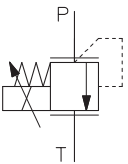
Hydraulic symbols	 <p><b>SRZME-A CART SRZME-A</b></p>		
Assembly position / location	Any position		
Subplate surface finishing (SRZME)	Roughness index Ra 0,4 - flatness ratio 0,01/100 (ISO 1101)		
MTTFd values according to EN ISO 13849	150 years, for further details see technical table P007		
Ambient temperature range	<b>Standard</b> and <b>/PE</b> = -20°C ÷ +70°C; <b>/BT</b> option = -40°C ÷ +60°C		
Storage temperature range	<b>Standard</b> and <b>/PE</b> = -20°C ÷ +80°C; <b>/BT</b> option = -40°C ÷ +70°C		
Coil code	<b>Standard</b> standard coil to be used with Atos drivers with power supply 24Vdc	option <b>/6</b> optional coil to be used with Atos drivers with power supply 12 Vdc	option <b>/18</b> optional coil to be used with electronic drivers not supplied by Atos, with power supply 24 Vdc and max current limited to 1A
Coil resistance R at 20°C	3,1 Ω	2,1 Ω	13,1 Ω
Max. solenoid current	2,5 A	3 A	1,2 A
Max. power	30 Watt		
Protection degree (CEI EN-60529)	<b>IP 65</b> (with connectors 666 correctly assembled)		
Duty factor	Continuous rating (ED=100%)		

Max regulated pressure [bar]	<b>50</b>	<b>100</b>	<b>210</b>	<b>315</b>	<b>350</b>
Min. regulated pressure [bar]	see min. pressure / flow diagrams at sect. 2				
Max. pressure at port P [bar]	350				
Max. pressure at port T [bar]	210				
Max. flow [l/min]	4				
Response time 0-100% step signal <b>(1)</b> (depending on installation) [ms]	≤ 70				
Hysteresis [% of the max pressure]	≤ 1,5				
Linearity [% of the max pressure]	≤ 3				
Repeatability [% of the max pressure]	≤ 2				

**Notes:** above performance data refer to valves coupled with Atos electronic drivers, see section 2.

**(1)** Average response time values; the pressure variation in consequence of a modification of the reference input signal to the valve is affected by the stiffness of the hydraulic circuit: greater is the stiffness of the circuit, faster is the dynamic response.

**4 SEALS AND HYDRAULIC FLUID** - for other fluids not included in below table, consult our technical office

Seals, recommended fluid temperature	NBR seals (standard) = -20°C ÷ +80°C, with HFC hydraulic fluids = -20°C ÷ +50°C FKM seals (/PE option) = -20°C ÷ +80°C HNBR seals (/BT option) = -40°C ÷ +60°C, with HFC hydraulic fluids = -40°C ÷ +50°C		
Recommended viscosity	20 ÷ 100 mm <sup>2</sup> /s - max allowed range 15 ÷ 380 mm <sup>2</sup> /s		
Max fluid contamination level	normal operation	ISO4406 class 18/16/13 NAS1638 class 7	see also filter section at www.atos.com or KTF catalog
	longer life	ISO4406 class 16/14/11 NAS1638 class 5	
<b>Hydraulic fluid</b>	<b>Suitable seals type</b>	<b>Classification</b>	<b>Ref. Standard</b>
Mineral oils	NBR, FKM, HNBR	HL, HLP, HLPD, HVLP, HVLPD	DIN 51524
Flame resistant without water	FKM	HFDU, HFDR	ISO 12922
Flame resistant with water	NBR, HNBR	HFC	

**5 GENERAL NOTES**

SRZME-A and CART SRZME proportional valves are CE marked according to the applicable Directives (e.g. Immunity/Emission EMC Directive and Low Voltage Directive).

**6 SOLENOID CONNECTIONS**

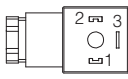
SOLENOID POWER SUPPLY CONNECTOR TYPE 666		
PIN	Signal description	
<b>1</b>	SUPPLY	
<b>2</b>	SUPPLY	
<b>3</b>	GND	

**7 DIAGRAMS** (based on mineral oil ISO VG 46 at 50 °C)

**1 Regulation diagrams**  
with flow rate Q = 1 l/min

**Note:** The presence of counter pressure at port T can affect the effective pressure regulation.

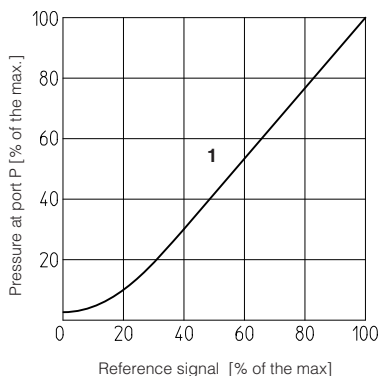

**2 Pressure/flow diagrams**  
with reference signal set at Q = 1 l/min

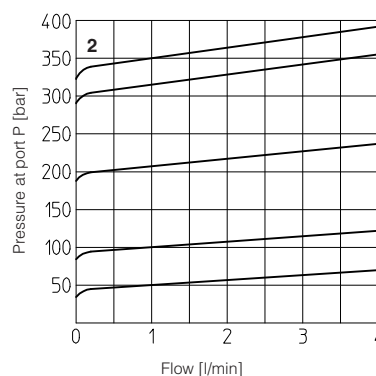

**3-7 Min. pressure/flow diagrams**  
with zero reference signal

- 3 = pressure range: 50
- 4 = pressure range: 100
- 5 = pressure range: 210
- 6 = pressure range: 315
- 7 = pressure range: 350

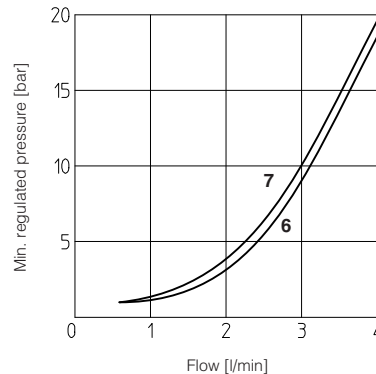
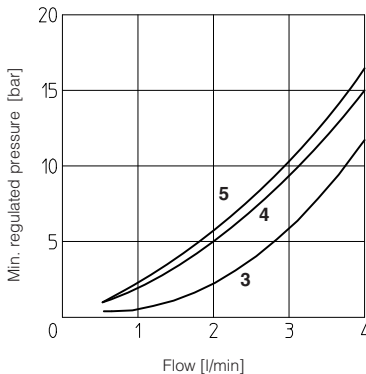

**8 AIR BLEEDING**

At the first valve commissioning the air eventually trapped inside the solenoid must be bled-off through the screw ① located at the rear side of the solenoid housing.  
The presence of air may cause pressure instability and vibrations.

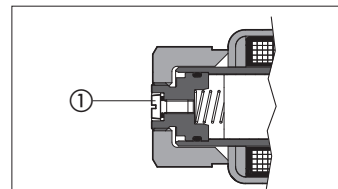

**9 COILS TYPE WITH SPECIAL CONNECTORS**

**Options -J**  
Coil type COZEJ  
AMP Junior Timer connector  
Protection degree IP67

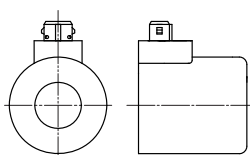

**Options -K**  
Coil type COZEK  
Deutsch connector, DT-04-2P male  
Protection degree IP67

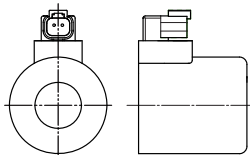

**Options -S**  
Coil type COZES  
Lead Wire connection  
Cable length = 180 mm

