

# Modular reducing valves type SHG, SKG

spool type, ISO 4401 sizes 06 and 10

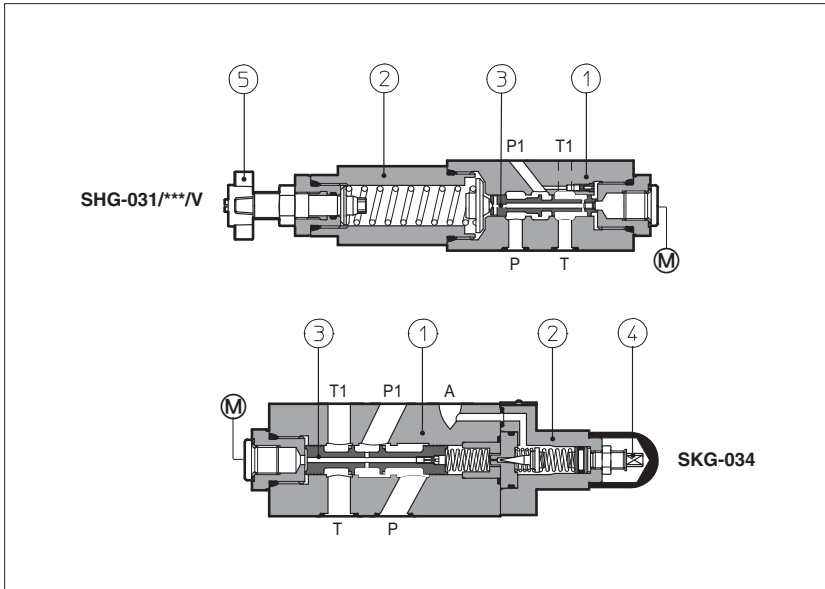

**SHG** and **SKG** are pressure reducing valves, spool type ③, designed to operate in oil hydraulic systems.

SHG are direct, three way valves; SKG are double stage ① ②, three way valves;

Clockwise rotation increases the pressure.

Valve size and max flow:

**SHG** = size 06 flow up to 50 l/min;

**SKG** = size 10 flow up to 100 l/min;

Mounting surface:

**ISO 4401 size 06 and 10**

Max pressure: **350 bar** for SHG

**315 bar** for SKG

## 1 MODEL CODE

<b>SHG-0</b>	<b>31</b>	/	<b>210</b>	/	<b>V</b>	/	<b>**</b>	/	<b>*</b>
Modular pressure reducing valve, size: <b>SHG-0</b> = 06 <b>SKG-0</b> = 10							Series number		Seals material, see sect. ③: - = NBR <b>PE</b> = FKM <b>BT</b> = HNBR
Configuration, see section ② three way: <b>31</b> = reduced pressure on P port <b>33</b> = reduced pressure on A port <b>34</b> = reduced pressure on B port			Pressure range <b>SHG</b> <b>32</b> = 3 - 32 bar <b>50</b> = 2 - 50 bar <b>75</b> = 10 - 75 bar				Options: <b>V</b> = setting adjustment by handwheel instead of a grub screw protected by cap		<b>SKG</b> <b>100</b> = 7 - 100 bar <b>210</b> = 8 - 210 bar

## 2 HYDRAULIC CHARACTERISTICS

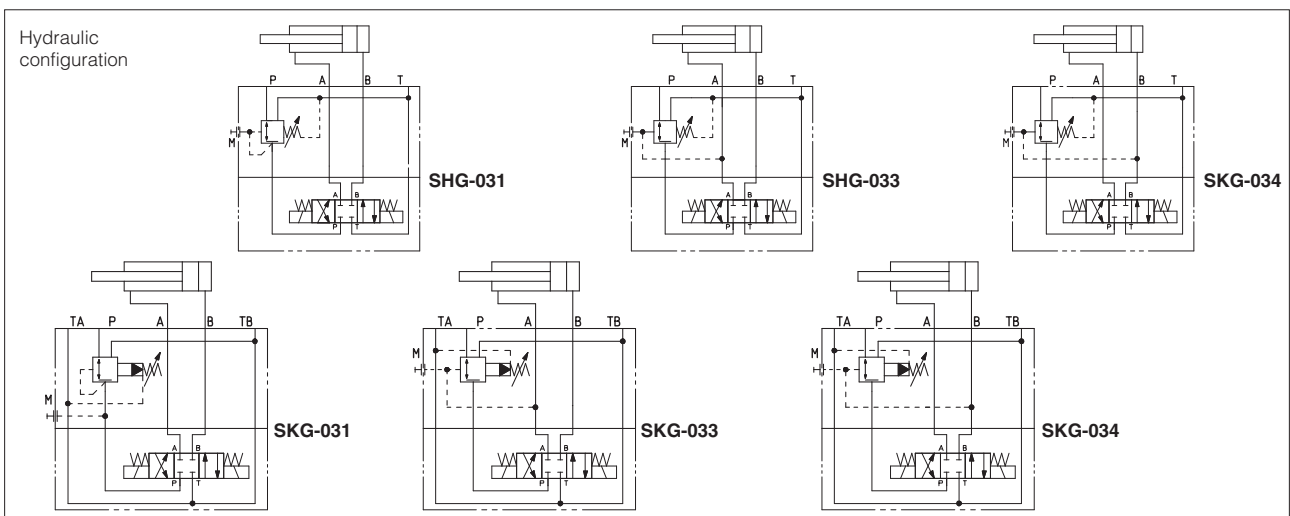

Valve model	SHG-03*/32	SHG-03*/50	SHG-03*/75	SHG-03*/100	SHG-03*/210	SKG-03*/100	SKG-03*/210
Max flow [l/min]	50					100	
Pressure range [bar]	3 ÷ 32	2 ÷ 50	10 ÷ 75	20 ÷ 100	50 ÷ 210	7 ÷ 100	8 ÷ 210
Max inlet pressure [bar]	350					315	
Max pressure on port T [bar]	160					160	

**3 MAIN CHARACTERISTICS, SEALS and HYDRAULIC FLUID** - for other fluids not included in below table, consult our technical office

Assembly position / location	Any position		
Subplate surface finishing	Roughness index Ra 0,4 - flatness ratio 0,01/100 (ISO 1101)		
MTTFd values according to EN ISO 13849	150 years, for further details see technical table P007		
Ambient temperature	Standard execution = -30°C ÷ +70°C /PE option = -20°C ÷ +70°C /BT option = -40°C ÷ +70°C		
Seals, recommended fluid temperature	NBR seals (standard) = -20°C ÷ +80°C, with HFC hydraulic fluids = -20°C ÷ +50°C FKM seals (/PE option) = -20°C ÷ +80°C HNBR seals (/BT option) = -40°C ÷ +60°C, with HFC hydraulic fluids = -40°C ÷ +50°C		
Recommended viscosity	15 ÷ 100 mm <sup>2</sup> /s - max allowed range 2.8 ÷ 500 mm <sup>2</sup> /s		
Max fluid contamination level	ISO4406 class 20/18/15 NAS1638 class 9, see also filter section at <a href="http://www.atos.com">www.atos.com</a> or KTF catalog		
<b>Hydraulic fluid</b>	<b>Suitable seals type</b>	<b>Classification</b>	<b>Ref. Standard</b>
Mineral oils	NBR, FKM, HNBR	HL, HLP, HLPD, HVLP, HVLPD	DIN 51524
Flame resistant without water	FKM	HFDR, HFDR	ISO 12922
Flame resistant with water	NBR, HNBR	HFC	

**4 DIAGRAMS OF SHG-03\*** based on mineral oil ISO VG 46 at 50°C

- 1** = regulated pressure variation versus flow:
  - between use port and discharge port
  - between inlet port and use port
- 2** = differential pressure variation versus flow between inlet port and use port
- 3** = differential pressure variation versus flow between use port and discharge port

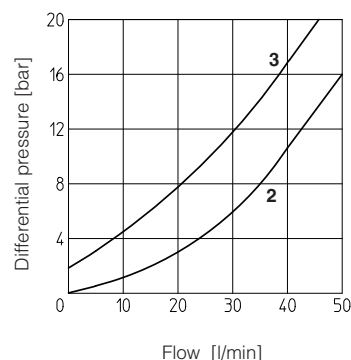
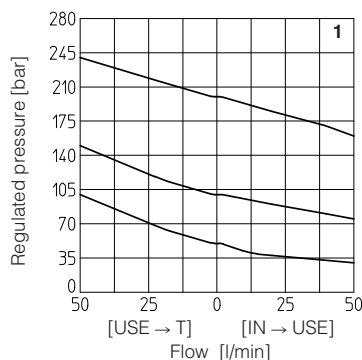

**5 DIAGRAMS OF SKG-03\*** based on mineral oil ISO VG 46 at 50°C

- 1** = regulated pressure variation versus flow:
  - between use port and discharge port
  - between inlet port and use port
- 2** = differential pressure variation versus flow between inlet port and use port
- 3** = differential pressure variation versus flow between use port and discharge port

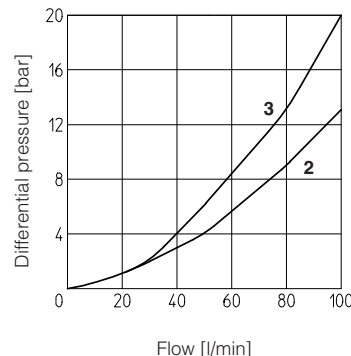
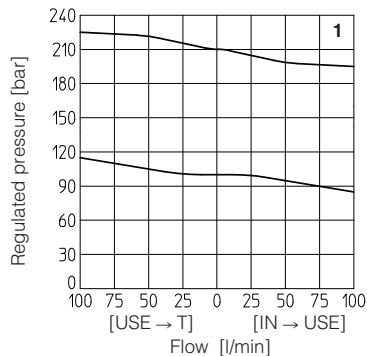

6 INSTALLATION DIMENSIONS OF SHG-0 VALVES [mm]

SHG-03\*

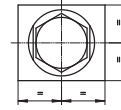
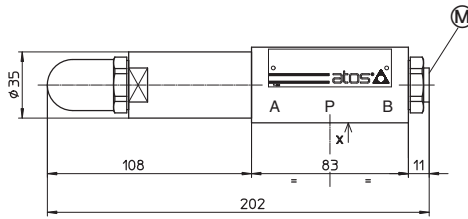
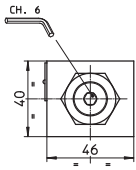

(M) = Pressure gauge port = G 1/4"

Mass: 2,3 Kg

Adjustment device for option /V

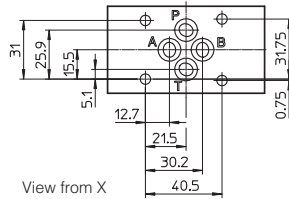
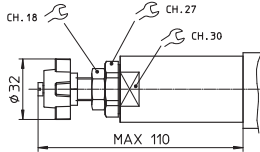

ISO 4401: 2005

Mounting surface: 4401-03-02-0-05

Diameter of ports A, B, P, T:  $\varnothing = 7,5$  mm

Seals: 4 OR 108

Fastening bolts: n° 4 socket head screws M5. The length depends on number and type of modular elements associated.

7 INSTALLATION DIMENSIONS OF SKG-0 VALVES [mm]

SKG-03\*

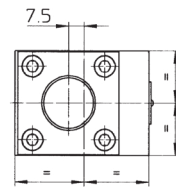
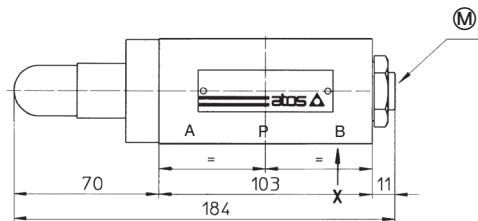
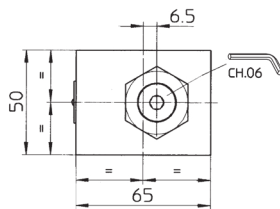

(M) = Pressure gauge port = G 1/4"

Mass: 3,8 kg

Adjustment device for option /V

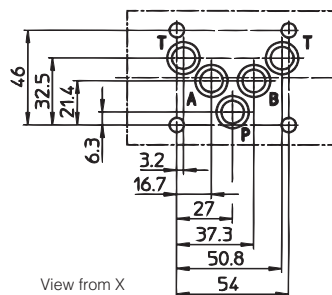
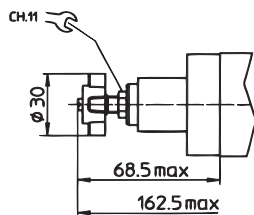

ISO 4401: 2005

Mounting surface: 4401-05-04-0-05

Diameter of ports A, B, P, T:  $\varnothing = 11,2$  mm

Seals: 5 OR 2050

Fastening bolts: n° 4 socket head screws M6. The length depends on number and type of modular elements associated.